



Passio (R-32) MCWE--GB



MCWE09-24GB5





Indoor Passio 9,000 BTU/HR Unit Model MCWE09GB5A00/AA

	PART NAME	P/N	LIST PRICE
 	Remote Control (30510050)	30510050+690417180001	1,400
	Indoor Motor FN20J-PG	150120874	1,800
	Main Board (30145075)	690412670001	3,600
	Display Board (300001000070)	690412270001	1,200
	Stepping Motor MP24AA (1521212901)	70-MOT00065	600
	Filter Sub-Assy (11122219) *ใช้ 2 ชั้น/เครื่อง	690414830001	300
	Biology Sterilization-static Filter (111220081)*ใช้ 2 ชั้น/เครื่อง	690418150001	300
	Cross Flow Fan (Blower) (10352059)	690412780001	1,400
	Temperature + Freeze Sensor (3900031302)	690412260001	300
	Evaporator Coil (01100100095)	690412840001	5,000
	Rear Case w/ Drain Pan Assy (20162010_AP324)	690414800001	2,400
	Front Panel (27230006165)	690414790001	1,200
	Frame Front (2002273001)	690412950001	1,200
	Installation Plate (01252043)	690414820001	1,200



Indoor Passio 12,000 BTU/HR Unit Model MCWE12GB5A00/AA

	PART NAME	P/N	LIST PRICE
 	Remote Control (30510050)	30510050+690417180001	1,400
	Indoor Motor FN20N-PG (1501214603)	690412700001	1,800
	Main Board (30145074)	690409870001	3,600
	Display Board (300001000070)	690412270001	1,200
	Stepping Motor MP24BA	1521210701	600
	Filter Sub-Assy (11122468) *ใช้ 2 ชั้น/เครื่อง	690414960001	300
	Biology Sterilization-static Filter (111220081)*ใช้ 2 ชั้น/เครื่อง	690418150001	300
	Cross Flow Fan (Blower) (10352056)	690412790001	1,400
	Temperature + Freeze Sensor (3900031302)	690412260001	300
	Evaporator Coil (01002695)	690412850001	6,000
	Rear Case w/ Drain Pan Assy (00000100093_AP324)	690414910001	2,400
	Front Panel (27230006265)	690414890001	1,200
	Frame Front (2002273101)	690413450001	1,200
	Installation Plate (01252484)	690414920001	1,200

Indoor Passio 15,000 BTU/HR Unit Model MCWE15GB5A00/01/AB

	PART NAME	P/N	LIST PRICE
 	Remote Control (30510050)	30510050+690417180001	1,400
	Indoor Motor FN25V-PG (1501214502)	690412340001	2,400
	Main Board (30135000149)	690409880001	3,600
	Display Board (300001000071)	690412280001	1,200
	Stepping Motor MP35CJ (1521240212)	690409590001	600
	Filter Sub-Assy (11122089) *ใช้ 2 ชั้น/เครื่อง	690412880001	300
	Biology Sterilization-static Filter (111220081)*ใช้ 2 ชั้น/เครื่อง	690418150001	300
	Cross Flow Fan (Blower) (10352060)	690412800001	1,400
	Temperature + Freeze Sensor (3900031302)	690412260001	300
	Evaporator Coil (01002686)	690412860001	7,000
	Rear Case w/ Drain Pan Assy (22202571_AP324)	690414380001	3,000
	Front Panel (27230006266)	690414310001	1,200
	Frame Front (2002272601)	690414330001	1,800
	Installation Plate (01362026)	690414410001	1,200

Indoor Passio 18,000 BTU/HR Unit Model MCWE18GB5A00/AA

	PART NAME	P/N	LIST PRICE
 	Remote Control (30510050)	30510050+690417180001	1,400
	Indoor Motor FN25V-PG (1501214502)	690412340001	2,400
	Main Board (30135000149)	690409880001	3,600
	Display Board (300001000071)	690412280001	1,200
	Stepping Motor MP35CJ (1521240212)	690409590001	600
	Filter Sub-Assy (11122089) *ใช้ 2 ชั้น/เครื่อง	690412880001	300
	Biology Sterilization-static Filter (111220081) *ใช้ 2 ชั้น/เครื่อง	690418150001	300
	Cross Flow Fan (Blower) (10352060)	690412800001	1,400
	Temperature + Freeze Sensor (3900031302)	690412260001	300
	Evaporator Coil (01002686)	690412860001	7,000
	Rear Case w/ Drain Pan Assy (22202571_AP324)	690414380001	3,000
	Front Panel (27230006266)	690414310001	1,200
	Frame Front (2002272601)	690414330001	1,800
	Installation Plate (01362026)	690414410001	1,200

Indoor Passio 24,000 BTU/HR Unit Model MCWE24GB5A00/AA

	PART NAME	P/N	LIST PRICE
	Remote Control (30510050)	30510050+690417180001	1,400
	Indoor Motor FN35A-PG (15012145)	690411000001	3,000
	Main Board (30145073)	690409890001	3,600
	Display Board (300001000071)	690412280001	1,200
	Stepping Motor MP35CJ (1521240212)	690409590001	600
	Filter Sub-Assy (11012007) *ใช้ 2 ชิ้น/เครื่อง	690412890001	300
	Biology Sterilization-static Filter (111220081)*ใช้ 2 ชิ้น/เครื่อง	690418150001	300
	Cross Flow Fan (Blower) (10352057)	690412810001	1,400
	Temperature + Freeze Sensor (3900031302)	690412260001	300
	Evaporator Coil (01100100052)	690412870001	9,000
	Rear Case w/ Drain Pan Assy (22202570_AP324)	690413440001	3,000
	Front Panel (27230006267)	690414440001	1,800
	Frame Front (00000200024)	690414450001	1,800
	Installation Plate (01252229)	690414500001	1,200

Passio (R-32) TTKE--GB

TTKE09-24GB5



Outdoor Passio 9,000 BTU/HR Unit Model TTKE09GB5E00/AA

	PART NAME	P/N	LIST PRICE
	Axial Flow Fan (10333427)	690412770001	1,100
	Fan Motor FW35X	150130676	2,100
	Compressor	CALL	
	Condenser Coil (011002000047)	690413460001	5,000

Outdoor Passio 12,000 BTU/HR Unit Model TTKE12GB5E00/AA

	PART NAME	P/N	LIST PRICE
	Axial Flow Fan (10333427)	690412770001	1,100
	Fan Motor FW35X	150130676	2,100
	Compressor	CALL	
	Condenser Coil (011002000073)	690413470001	7,000

Outdoor Passio 15,000 BTU/HR Unit Model TTKE15GB5E00

	PART NAME	P/N	LIST PRICE
	Axial Flow Fan (10333427)	690412770001	1,100
	Fan Motor FW48G (1501307103)	690412710001	3,000
	Compressor	CALL	
	Condenser Coil (01100200675)	690416530001	8,000

Outdoor Passio 15,000 BTU/HR Unit Model TTKE15GB5E01/AB

	PART NAME	P/N	LIST PRICE
	Axial Flow Fan (10333016)	690412750001	1,400
	Fan Motor LW40B (15013075)	690412720001	3,600
	Compressor	CALL	
	Condenser Coil (01100200676)	690416540001	9,000

Outdoor Passio 18,000 BTU/HR Unit Model TTKE18GB5E00/AA

	PART NAME	P/N	LIST PRICE
	Axial Flow Fan (10333016)	690412750001	1,400
	Fan Motor LW40B (15013075)	690412720001	3,600
	Compressor	CALL	
	Condenser Coil (01100200676)	690416540001	9,000

Outdoor Passio 24,000 BTU/HR Unit Model TTKE24GB5E00/AA



	PART NAME	P/N	LIST PRICE
	Axial Flow Fan (10333023)	690412760001	1,400
	Fan Motor LW50G (15015068)	690412730001	3,600
	Compressor	CALL	
	Condenser Coil (01100200671)	690416550001	14,400

Passio Inverter (R-32) MYWE--GB



MYWE09-24GB5



Indoor Passio Inverter 9,000 BTU/HR Unit Model MYWE09GB5A00/AA

	PART NAME	P/N	LIST PRICE
 	Remote Control (30510474)	690412330001	1,400
	Indoor Motor FN20J-PG (1501208904)	690418130001	1,800
	Main Board (300002000182)	690418140001	3,600
	Display Board (300001000070)	690412270001	1,200
	Stepping Motor MP24AA (1521212901)	70-MOT00065	600
	Filter Sub-Assy (11122219) *ใช้ 2 ชั้น/เครื่อง	690414830001	300
	Biology Sterilization-static Filter (111220081)*ใช้ 2 ชั้น/เครื่อง	690418150001	300
	Cross Flow Fan (Blower) (10352059)	690412780001	1,400
	Temperature + Freeze Sensor (3900031302)	690412260001	300
	Evaporator Coil (0110010009505)	690418160001	5,000
	Rear Case w/ Drain Pan Assy	20162010	2,400
	Front Panel	2002269601S	1,200
	Frame Front (2002273001)	690412950001	1,200
	Installation Plate (01252043)	690414820001	1,200

Indoor Passio Inverter 12,000 BTU/HR Unit Model MYWE12GB5A00/AA

	PART NAME	P/N	LIST PRICE
 	Remote Control (30510474)	690412330001	1,400
	Indoor Motor FN20V-PG (15012146)	70-MOT00064	2,400
	Main Board (300002000178)	690412300001	3,600
	Display Board (300001000070)	690412270001	1,200
	Stepping Motor MP24BA (1521210710)	1521210701	600
	Filter Sub-Assy (11122468) *ใช้ 2 ชั้น/เครื่อง	690414960001	300
	Biology Sterilization-static Filter (111220081) *ใช้ 2 ชั้น/เครื่อง	690418150001	300
	Cross Flow Fan (Blower) (10352056)	690412790001	1,400
	Temperature + Freeze Sensor (3900031302)	690412260001	300
	Evaporator Coil (01100100245)	690418170001	6,000
	Rear Case w/ Drain Pan Assy	00000100093	2,400
	Front Panel	2002266101S	1,200
	Frame Front (2002273101)	690413450001	1,200
	Installation Plate (01252484)	690414920001	1,200

Indoor Passio Inverter 18,000 BTU/HR Unit Model MYWE18GB5A00/AA

	PART NAME	P/N	LIST PRICE
	Remote Control (30510474)	690412330001	1,400
	Indoor Motor FN25V-PG (1501214502)	690412340001	2,400
	Main Board (300002000180)	690412310001	3,600
	Display Board (300001000071)	690412280001	1,200
	Stepping Motor MP35CJ (1521240212)	690409590001	600
	Filter Sub-Assy (11122089) *ใช้ 2 ชิ้น/เครื่อง	690412880001	300
	Biology Sterilization-static Filter (111220081) *ใช้ 2 ชิ้น/เครื่อง	690418150001	300
	Cross Flow Fan (Blower) (10352060)	690412800001	1,400
	Temperature + Freeze Sensor (3900031302)	690412260001	300
	Evaporator Coil (011001000207)	690421090001	7,000
	Rear Case w/ Drain Pan Assy	22202571	3,000
	Front Panel	2002269501S	1,200
	Frame Front (2002272601)	690414330001	1,800
	Installation Plate (01362026)	690414410001	1,200

Indoor Passio Inverter 24,000 BTU/HR Unit Model MYWE24GB5A00/AA

	PART NAME	P/N	LIST PRICE
	Remote Control (30510474)	690412330001	1,400
	Indoor Motor FN35A-PG (15012145)	690411000001	3,000
	Main Board (300002000181)	690412320001	3,600
	Display Board (300001000071)	690412280001	1,200
	Stepping Motor MP35CJ (1521240212)	690409590001	600
	Filter Sub-Assy (11012007) *ใช้ 2 ชิ้น/เครื่อง	690412890001	300
	Biology Sterilization-static Filter (111220081) *ใช้ 2 ชิ้น/เครื่อง	690418150001	300
	Cross Flow Fan (Blower) (10352057)	690412810001	1,400
	Temperature + Freeze Sensor (3900031302)	690412260001	300
	Evaporator Coil (11001000095)	690418190001	5,000
	Rear Case w/ Drain Pan Assy	22202570	3,000
	Front Panel	2002270001S	1,800
	Frame Front (00000200024)	690414450001	1,800
	Installation Plate (01252229)	690414500001	1,200

Passio Inverter (R-32) TYKE---GB

TYKE09-24GB5



Outdoor Passio Inverter 9,000 BTU/HR Unit Model TYKE09GB5E00/AA

	PART NAME	P/N	LIST PRICE
	Axial Flow Fan	10333004	1,100
	Fan Motor FW30J-ZL (1501308506)	690418200001	4,200
	Main board (300027000159)	690418210001	8,400
	Compressor	CALL	
	Condenser Coil	011002000300	9,000

Outdoor Passio Inverter 12,000 BTU/HR Unit Model TYKE12GB5E00/AA

	PART NAME	P/N	LIST PRICE
	Axial Flow Fan (10333427)	690412770001	1,100
	Fan Motor FW30J-ZL (15013085)	690404490001	4,800
	Main board (300027000122)	690418220001	10,800
	Compressor	CALL	
	Condenser Coil	011002000247	9,500

Outdoor Passio Inverter 18,000 BTU/HR Unit Model TYKE18GB5E00/AA

	PART NAME	P/N	LIST PRICE
	Axial Flow Fan	10335008	1,400
	Fan Motor LW60M-ZL (1501506402)	690412290001	5,400
	Main board (300027000120)	690418230001	14,400
	Temperature Sensor (3900030901)	690404310001	500
	Compressor	CALL	
	Condenser Coil	011002000299	15,000

Outdoor Passio Inverter 24,000 BTU/HR Unit Model TYKE24GB5E00/AA

	PART NAME	P/N	LIST PRICE
	Axial Flow Fan	10335008	1,400
	Fan Motor LW60M-ZL (1501506402)	690412290001	5,400
	Main board (300027000131)	690418240001	14,400
	Temperature Sensor (3900030902)	690418250001	500
	Compressor	CALL	
	Condenser Coil	011002000244	15,000



HI-WALL PARTS LIST

Bravo Inverter (R-410A) MCWA---BB/TTKA--BB

MCWA09-A18BB5A00





Indoor Bravo Inverter 9,000 BTU/HR Unit Model MCWA09BB5A00

	PART NAME	P/N	LIST PRICE
 	Remote Control (30510049)	30510049+690417180001	1,400
	Indoor Motor FN20J-PG	150120874	1,800
	Main Board w/o Transformer (30138475)	690404240001	3,600
	Main Board w/ Transformer (30139040)	690420300001	3,600
	Display Board	30565088	1,400
	Stepping Motor MP24AA (1521212901)	70-MOT00065	600
	Filter Sub-Assy (1112220403) *ใช้ 2 ชั้น/เครื่อง	70-FILT0185	300
	Catechin Filter (111200511) *ใช้ 2 ชั้น/เครื่อง	70-FILT0068	300
	Cross Flow Fan (Blower)	10352017	1,400
	Temperature Sensor	390000451	300
	Freeze Sensor	390000591	300
	Evaporator Coil (01002321)	690404170001	7,800
	Rear Case w/ Drain Pan Assy	2220210302_AP324	3,000
	Front Panel	20012464_K94152	1,800
	Frame Front (2001213901)	70-CASE0009	1,200
Installation Plate (01252021)	70-OTHR0138	1,200	

Indoor Bravo Inverter 12,000 BTU/HR Unit Model MCWA12BB5A00

	PART NAME	P/N	LIST PRICE
 	Remote Control (30510049)	30510049+690417180001	1,400
	Indoor Motor FN20J-PG	150120874	1,800
	Main Board w/o Transformer (30138475)	690404240001	3,600
	Main Board w/ Transformer (30139040)	690420300001	3,600
	Display Board	30565088	1,400
	Stepping Motor MP24AA (1521212901)	70-MOT00065	600
	Filter Sub-Assy (1112220403) *ใช้ 2 ชั้น/เครื่อง	70-FILT0185	300
	Catechin Filter (111200511) *ใช้ 2 ชั้น/เครื่อง	70-FILT0068	300
	Cross Flow Fan (Blower)	10352017	1,400
	Temperature Sensor	390000451	300
	Freeze Sensor	390000591	300
	Evaporator Coil (0100256502)	690404180001	7,800
	Rear Case w/ Drain Pan Assy	2220210302_AP324	3,000
	Front Panel	20012464_K94152	1,800
	Frame Front (2001213901)	70-CASE0009	1,200
Installation Plate (01252021)	70-OTHR0138	1,200	



Indoor Bravo Inverter 18,000 BTU/HR Unit Model MCWA18BB5A00

	PART NAME	P/N	LIST PRICE
 	Remote Control (30510049)	30510049+690417180001	1,400
	Indoor Motor FN20V-PG (15012146)	70-MOT00064	2,400
	Main Board (30138758)	690404250001	3,600
	Display Board	30565088	1,400
	Stepping Motor MP28VB	15012086	600
	Filter Sub-Assy *ใช้ 2 ชั้น/เครื่อง	1112208901	300
	Catechin Filter (111200511) *ใช้ 2 ชั้น/เครื่อง	70-FILT0068	300
	Cross Flow Fan (Blower) (10352019)	70-BLOW0005	1,400
	Temperature Sensor	390000453	300
	Freeze Sensor (390000632)	690404290001	300
	Evaporator Coil (01002575)	690401010001	8,400
	Rear Case w/ Drain Pan Assy (12312214_AP324)	70-CASE0022	3,000
	Front Panel	20012466_K94152	1,800
	Frame Front (202205)	70-CASE0019	1,800
	Installation Plate (01252218)	70-OTHR0210	1,200

MCWA24BB5A00



Indoor Bravo Inverter 24,000 BTU/HR Unit Model MCWA24BB5A00

	PART NAME	P/N	LIST PRICE
 	Remote Control (30510049)	30510049+690417180001	1,400
	Indoor Motor FN60A-ZL (15012134)	690418260001	4,800
	Main Board (30148196)	690413010001	3,600
	Display Board (30565210)	690413020001	1,200
	Stepping Motor Vertical MP35CJ (1521240212, 1521240208)	690409590001	600
	Stepping Motor Vertical MP24HB (1521212602)	690413000001	600
	Stepping Motor Horizontal MP24HC (1521212301)	690418030001	600
	Filter Sub-Assy (11122136) *ใช้ 2 ชั้น/เครื่อง	690416190001	300
	Catechin Filter (111200511) *ใช้ 2 ชั้น/เครื่อง	70-FILT0068	300
	Cross Flow Fan (Blower)	10352420	1,400
	Temperature Sensor	390000451	300
	Freeze Sensor (390000598)	690413030001	300
	Evaporator Coil	01002000013	12,000
	Rear Case w/ Drain Pan Assy (22202271)	690418280001	3,600
	Front Panel	20022299_K94152	1,800
Frame Front	20022298	1,800	
Installation Plate (01252398)	70-OTHR0126	1,200	

Bravo Inverter (R-410A) TTKA--BB

TTKA09-A24BB5E00



Outdoor Bravo Inverter 9,000 BTU/HR Unit Model TTKA09BB5E00

	PART NAME	P/N	LIST PRICE
	Axial Flow Fan	10333004	1,100
	Fan Motor FW30J-ZL (1501308502)	690418290001	4,200
	Main board (30148045)	690404280001	8,400
	Temperature Sensor (3900030804)	690404300001	500
	Compressor	CALL	
	Condenser Coil (01163210)	690404210001	10,800

Outdoor Bravo Inverter 12,000 BTU/HR Unit Model TTKA12BB5E00

	PART NAME	P/N	LIST PRICE
	Axial Flow Fan	10333004	1,100
	Fan Motor FW30J-ZL (15013085)	690404490001	4,800
	Main board (30148016)	690404270001	10,800
	Temperature Sensor (3900030903)	690404320001	500
	Compressor	CALL	
	Condenser Coil (01163211)	690404220001	11,400

Outdoor Bravo Inverter 18,000 BTU/HR Unit Model TTKA18BB5E00

	PART NAME	P/N	LIST PRICE
	Axial Flow Fan	10335008	1,400
	Fan Motor LW60K (1501506301)	690404230001	5,400
	Main board (301389901)	690404260001	14,400
	Temperature Sensor (3900030901)	690404310001	500
	Compressor	CALL	
	Condenser Coil (01163154)	690404200001	18,000

Outdoor Bravo Inverter 24,000 BTU/HR Unit Model TTKA24BB5E00

	PART NAME	P/N	LIST PRICE
	Axial Flow Fan (10335005)	70-FAN00035	1,400
	Fan Motor LW92B-ZL (150104000001)	690413050001	5,400
	Main board (301388341)	690413060001	16,200
	Temperature Sensor (3900030901)	690404310001	500
	Compressor	CALL	
	Condenser Coil	01163173_K94152	18,000

Bravo MCW---BB/TTK---BB

MCW509-518BB5A00



Indoor Bravo 9,000 BTU/HR Unit Model MCW509BB5A00

	PART NAME	P/N	LIST PRICE
	Remote Control (30510050)	30510050+690417180001	1,400
	Indoor Motor FN20J-PG	150120874	1,800
	Main Board	30035563	3,000
	Display Board	30565088	1,400
	Stepping Motor MP24AA (1521210901)	70-MOT00065	600
	Filter Sub-Assy *ใช้ 2 ชั้น/เครื่อง	1112220401	300
	Catechin Filter (111200511) *ใช้ 2 ชั้น/เครื่อง	70-FILT0068	300
	Cross Flow Fan (Blower)	10352017	1,400
	Temperature Sensor	390000451	300
	Freeze Sensor	390000591	300
	Evaporator Coil (0100257401)	70-COIL0020	7,200
	Rear Case w/ Drain Pan Assy (2220210301_AP324)	70-CASE0008	3,000
	Front Panel (20012464_K44579)	70-CASE0012	1,800
	Frame Front (2001213901)	70-CASE0009	1,200
Installation Plate (01252021)	70-OTHR0138	1,200	

Indoor Bravo 12,000 BTU/HR Unit Model MCW512BB5A00

	PART NAME	P/N	LIST PRICE
	Remote Control (30510050)	30510050+690417180001	1,400
	Indoor Motor FN20J-PG	150120874	1,800
	Main Board (30035565/3013582)	70-BRD00026	3,000
	Display Board	30565088	1,400
	Stepping Motor MP24AA (1521210901)	70-MOT00065	600
	Filter Sub-Assy *ใช้ 2 ชั้น/เครื่อง	1112220401	300
	Catechin Filter (111200511) *ใช้ 2 ชั้น/เครื่อง	70-FILT0068	300
	Cross Flow Fan (Blower)	10352017	1,400
	Temperature Sensor	390000451	300
	Freeze Sensor	390000591	300
	Evaporator Coil	0100256501	7,200
	Rear Case w/ Drain Pan Assy (2220210301_AP324)	70-CASE0008	3,000
	Front Panel (20012464_K44579)	70-CASE0012	1,800
	Frame Front (2001213901)	70-CASE0009	1,200
Installation Plate (01252021)	70-OTHR0138	1,200	

Indoor Bravo 12,000 BTU/HR Unit Model MCW512BB5A01

	PART NAME	P/N	LIST PRICE
	Remote Control (30510050)	30510050+690417180001	1,400
	Indoor Motor FN20J-PG	150120874	1,800
	Main Board (30035565/3013582)	70-BRD00026	3,000
	Display Board	30565088	1,400
	Stepping Motor MP24AA (1521210901)	70-MOT00065	600
	Filter Sub-Assy (1112220403) *ใช้ 2 ชั้น/เครื่อง	70-FILT0185	300
	Catechin Filter (111200511) *ใช้ 2 ชั้น/เครื่อง	70-FILT0068	300
	Cross Flow Fan (Blower)	10352017	1,400
	Temperature Sensor	390000451	300
	Freeze Sensor	390000591	300
	Evaporator Coil	0100256501	7,200
	Rear Case w/ Drain Pan Assy (2220210301_AP324)	70-CASE0008	3,000
	Front Panel (20012464_K44579)	70-CASE0012	1,800
	Frame Front (2001213901)	70-CASE0009	1,200
	Installation Plate (01252021)	70-OTHR0138	1,200

Indoor Bravo 15,000 BTU/HR Unit Model MCW515BB5A00

	PART NAME	P/N	LIST PRICE
	Remote Control (30510050)	30510050+690417180001	1,400
	Indoor Motor FN20V-PG (15012146)	70-MOT00064	2,400
	Main Board	30135453	3,000
	Display Board	30565088	1,400
	Stepping Motor MP28VB	15012086	600
	Filter Sub-Assy *ใช้ 2 ชั้น/เครื่อง	1112208901	300
	Catechin Filter (111200511) *ใช้ 2 ชั้น/เครื่อง	70-FILT0068	300
	Cross Flow Fan (Blower) (10352019)	70-BLOW0005	1,400
	Temperature Sensor	390000453	300
	Freeze Sensor	390000591	300
	Evaporator Coil (01002575)	690401010001	8,400
	Rear Case w/ Drain Pan Assy (12312214_AP324)	70-CASE0022	3,000
	Front Panel (20012466_K44579)	70-CASE0021	1,800
	Frame Front (2022205)	70-CASE0019	1,800
	Installation Plate (01252218)	70-OTHR0210	1,200

Indoor Bravo 18,000 BTU/HR Unit Model MCW518BB5A00

	PART NAME	P/N	LIST PRICE
	Remote Control (30510050)	30510050+690417180001	1,400
	Indoor Motor FN25A-PG	15012098	2,400
	Main Board	30135296	3,000
	Display Board	30565088	1,400
	Stepping Motor MP35XX	1521300101	600
	Filter Sub-Assy *ใช้ 2 ชั้น/เครื่อง	11122091	300
	Catechin Filter (111200511) *ใช้ 2 ชั้น/เครื่อง	70-FILT0068	300
	Cross Flow Fan (Blower)	10352030	1,400
	Temperature Sensor	390000451	300
	Freeze Sensor	390000591	300
	Evaporator Coil	0100257204	8,400
	Rear Case w/ Drain Pan Assy	22202117	3,600
	Front Panel (20012552_K44579)	690401740001	1,800
	Frame Front	2001229501	1,800
Installation Plate	01252004	1,200	

Indoor Bravo 18,000 BTU/HR Unit Model MCW518BB5A01

	PART NAME	P/N	LIST PRICE
	Remote Control (30510050)	30510050+690417180001	1,400
	Indoor Motor FN20V-PG (15012146)	70-MOT00064	2,400
	Main Board (301354531)	70-BRD00036	3,000
	Display Board	30565088	1,400
	Stepping Motor MP28VB	15012086	600
	Filter Sub-Assy *ใช้ 2 ชั้น/เครื่อง	1112208901	300
	Catechin Filter (111200511) *ใช้ 2 ชั้น/เครื่อง	70-FILT0068	300
	Cross Flow Fan (Blower) (10352019)	70-BLOW0005	1,400
	Temperature Sensor	390000451	300
	Freeze Sensor	390000591	300
	Evaporator Coil (01002575)	690401010001	8,400
	Rear Case w/ Drain Pan Assy (12312214_AP324)	70-CASE0022	3,000
	Front Panel (20012466_K44579)	70-CASE0021	1,800
	Frame Front (202205)	70-CASE0019	1,800
Installation Plate (01252218)	70-OTHR0210	1,200	

MCW524BB5A00



Indoor Bravo 24,000 BTU/HR Unit Model MCW524BB5A00

	PART NAME	P/N	LIST PRICE
	Remote Control (30510050)	30510050+690417180001	1,400
	Indoor Motor FN25E (150121057)	70-FAN00005	3,000
	Main Board	30135377	3,000
	Display Board	30565017	1,200
	Stepping Motor MP24BA	1521210701	600
	Filter Sub-Assy *ใช้ 2 ชั้น/เครื่อง	11122112	300
	Catechin Filter *ใช้ 2 ชั้น/เครื่อง	70-FILT0222	300
	Cross Flow Fan (Blower)	10352420	1,400
	Temperature Sensor	390000451	300
	Freeze Sensor	390000591	300
	Evaporator Coil (01002924)	70-COIL0047	14,400
	Rear Case w/ Drain Pan Assy (22202092)	690409680001	3,600
	Front Panel (27222169001)	70-CASE0024	1,800
	Frame Front (Back) (2000257202)	70-CASE0025	1,300
Frame Front (Front) (2000237002)	70-CASE0023	1,200	
Installation Plate (01252398)	70-OTHR0126	1,200	

Bravo TTK---BB

TTK509-524BB5E00



Outdoor Bravo 9,000 BTU/HR Unit Model TTK509BB5E00

	PART NAME	P/N	LIST PRICE
	Axial Flow Fan	10333004	1,100
	Fan Motor FW25K	150130671	2,100
	Compressor	CALL	
	Condenser Coil (0111339702K44579)	70-COIL0024	8,400

Outdoor Bravo 12,000 BTU/HR Unit Model TTK512BB5E00

	PART NAME	P/N	LIST PRICE
	Axial Flow Fan	10333004	1,100
	Fan Motor FW35X	150130676	2,100
	Compressor	CALL	
	Condenser Coil (01113492K44579)	70-COIL0029	10,800

Outdoor Bravo 12,000 BTU/HR Unit Model TTK512BB5E01

	PART NAME	P/N	LIST PRICE
	Axial Flow Fan	10333004	1,100
	Fan Motor FW35X	150130676	2,100
	Compressor	CALL	
	Condenser Coil (1113958)	70-COIL0032	10,800

Outdoor Bravo 15,000 BTU/HR Unit Model TTK515BB5E00

	PART NAME	P/N	LIST PRICE
	Axial Flow Fan	10335257	1,400
	Fan Motor LW68B	15015057	3,000
	Compressor	CALL	
	Condenser Coil (01113851)	70-COIL0031	10,800

Outdoor Bravo 18,000 BTU/HR Unit Model TTK518BB5E00

	PART NAME	P/N	LIST PRICE
	Axial Flow Fan	10335008	1,400
	Fan Motor LW60J	1501506102	3,000
	Compressor	CALL	
	Condenser Coil (01113511K44579)	70-COIL0030	15,600

Outdoor Bravo 18,000 BTU/HR Unit Model TTK518BB5E01

	PART NAME	P/N	LIST PRICE
	Axial Flow Fan	10335008	1,400
	Fan Motor LW60J	1501506102	3,000
	Compressor	CALL	
	Condenser Coil (1163890)	70-COIL0034	15,600

Outdoor Bravo 24,000 BTU/HR Unit Model TTK524BB5E00

	PART NAME	P/N	LIST PRICE
	Axial Flow Fan (10335005)	70-FAN00035	1,400
	Fan Motor (BEFORE YEAR 2012) **ต้องเปลี่ยนพร้อมใบพัด 10335008 เท่านั้น**	1501506102+10335008	4,200
	Fan Motor LW60J (AFTER YEAR 2012)	1501506102	3,000
	Compressor	CALL	
	Condenser Coil	01113961K44579	19,800

Triple E MCW---DB/TTK---DB

1



Indoor Triple E Model MCW509DB5A01



	PART NAME	P/N	LIST PRICE
	Remote Controller (024-1000)	1090130033	1,800
	Indoor Motor (024-0999)	1170030047	2,200
	Main Control Board (024-1001)	1090320903	3,000
	Display Board (024-1041) *อิเล็กทรอนิกส์ภายใน*	1090250119	CALL
	Stepping Motor (024-1002)	1170020011	600
	Filter *ใช้ 2 ชั้น/เครื่อง	1070250106	300
	Cross Flow Fan (Blower) (028-1817)	1070020026	1,400
	Temperature Sensor+Freeze Sensor	70-SENS0012	400
	Evaporator Coil (1110050315)	70-COIL0008	CALL
	Drain Pan Assy (1070320437)	70-DRAN0006	CALL
	Front Panel+Display Cover (1070320133+1070251001)	70-PANL0019+70-COVE0002	CALL
	Frame Front (1070320204)	70-OTHR0080	CALL
	Installation Plate	1080030008	CALL

Indoor Triple E Model MCW512DB5A01



	PART NAME	P/N	LIST PRICE
	Remote Controller (024-1000)	1090130033	1,800
	Indoor Motor (024-1007) *อิเล็กทรอนิกส์ภายใน*	1170030047-1	CALL
	Main Control Board (024-1005)	1090500510	3,900
	Display Board (024-1006) *อิเล็กทรอนิกส์ภายใน*	1090500507	CALL
	Stepping Motor (024-1002)	1170020011	600
	Left Filter **CHECK SIZE** (Size34.6x40.6cm.)	1070190067	300
	Right Filter **CHECK SIZE** (Size34.6x40.6cm.)	1070190068	300
	Cross Flow Fan (Blower) (028-1851)	1070020014	1,400
	Temperature Sensor+Freeze Sensor	70-SENS0012	400
	Evaporator Coil	1213090105	CALL
	Drain Pan Assy-After2009 Model (1070701048)	70-DRAN0013	CALL
	Front Panel (1070500696)	70-CASE0026	CALL
	Frame Front (1070701162)	70-OTHR0282	CALL
	Installation Plate (1080030001)	70-OTHR0194	CALL

1

Indoor Triple E Model MCW512DB5A11

	PART NAME	P/N	LIST PRICE
 	Remote Controller (024-1000)	1090130033	1,800
	Indoor Motor (024-1337)	1170030067	2,400
	Main Control Board (024-1336, 1090500141)	690412030001	3,000
	Display Board (024-1041) *อิเล็กทรอนิกส์ไม่พร้อม*	1090250119	CALL
	Stepping Motor (024-1002)	1170020011	600
	Left Filter **CHECK SIZE** 1070190012 (Size34.5x40cm.) 70-FILT0070 (Size29x34cm.) *อิเล็กทรอนิกส์ไม่พร้อม*	70-FILT0070	CALL
	Right Filter **CHECK SIZE** 1070190013 (Size32.5x40cm.) 70-FILT0071 (Size28.5x31cm.) *อิเล็กทรอนิกส์ไม่พร้อม*	70-FILT0071	CALL
	Cross Flow Fan (Blower) (028-2088)	1070020024	1,400
	Temperature Sensor+Freeze Sensor	70-SENS0012	400
	Evaporator Coil (1110051119)	70-COIL0021	CALL
	Drain Pan Assy (1300350615)	70-DRAN0008	CALL
	Front Panel (1070450105)	70-CASE0027	CALL
	Frame Front (1070500250)	70-OTHR0284	CALL
Installation Plate (1080030021)	70-CASE0014	CALL	

Indoor Triple E Model MCW518DB5A01

	PART NAME	P/N	LIST PRICE
 	Remote Controller (024-1000)	1090130033	1,800
	Indoor Motor (024-1028)	1170030048	2,700
	Main Control Board (024-1005)	1090500510	3,900
	Display Board (024-1006) *อิเล็กทรอนิกส์ไม่พร้อม*	1090500507	CALL
	Stepping Motor (024-1002)	1170020011	600
	Left Filter **CHECK SIZE** (Size34.6x40.6cm.)	1070190067	300
	Right Filter **CHECK SIZE** (Size34.6x40.6cm.)	1070190068	300
	Cross Flow Fan (Blower) (028-1851)	1070020014	1,400
	Temperature Sensor+Freeze Sensor	70-SENS0012	400
	Evaporator Coil (1110050926)	70-COIL0003	CALL
	Drain Pan Assy-After2009 Model (1070701048)	70-DRAN0013	CALL
	Front Panel (1070500696)	70-CASE0026	CALL
	Frame Front (1070701162)	70-OTHR0282	CALL
Installation Plate (1080030001)	70-OTHR0194	CALL	

Indoor Triple E Model MCW524DB0A01

	PART NAME	P/N	LIST PRICE
	Remote Controller (024-1000)	1090130033	1,800
	Indoor Motor (024-1028)	1170030048	2,700
	Main Control Board (024-1005)	1090500510	3,900
	Display Board (024-1006) *อิเล็กทรอนิกส์ไม่มีชื่อ-ไม่กำหนดแทน*	1090500507	CALL
	Stepping Motor (024-1002)	1170020011	600
	Left Filter **CHECK SIZE** (Size34.6x40.6cm.)	1070190067	300
	Right Filter **CHECK SIZE** (Size34.6x40.6cm.)	1070190068	300
	Cross Flow Fan (Blower) (028-1851)	1070020014	1,400
	Temperature Sensor+Freeze Sensor	70-SENS0012	400
	Evaporator Coil (1110050962)	70-COIL0038	CALL
	Drain Pan Assy-After2009 Model (1070701048)	70-DRAN0013	CALL
	Front Panel (1070500696)	70-CASE0026	CALL
	Frame Front (1070701162)	70-OTHR0282	CALL
Installation Plate (1080030001)	70-OTHR0194	CALL	

TTK509-518DB5



Outdoor Triple E Model TTK509DB5E01

	PART NAME	P/N	LIST PRICE
	Outdoor Motor (024-1008) *อิเล็กทรอนิกส์ไม่มีชื่อ-ไม่กำหนดแทน*	1170040059+1170100027	CALL
	Axial Flow Fan (Fan Disk) (028-1857)	1070030012	1,100
	Compressor 2P16S225AND	CALL	
	Condenser Coil (1110060406)	70-COIL0014	CALL

Outdoor Triple E Model TTK509DB5E11

	PART NAME	P/N	LIST PRICE
	Outdoor Motor (024-1008) *อิเล็กทรอนิกส์ไม่มีชื่อ-ไม่กำหนดแทน*	1170040059+1170100027	CALL
	Axial Flow Fan (Fan Disk) (028-1857)	1070030012	1,100
	Compressor QK164PFA	CALL	
	Condenser Coil (1110060406)	70-COIL0014	CALL

Outdoor Triple E Model TTK512DB5E01

	PART NAME	P/N	LIST PRICE
	Outdoor Motor (024-1008) *อิเล็กทรอนิกส์ไม่มีชื่อ-ไม่กำหนดแทน*	1170040059+1170100027	CALL
	Axial Flow Fan (Fan Disk) (028-1857)	1070030012	1,100
	Compressor PH200X2C-4FT1	CALL	
	Condenser Coil (1110060406)	70-COIL0014	CALL

Outdoor Triple E Model TTK512DB5E21

	PART NAME	P/N	LIST PRICE
	Outdoor Motor (024-1008) *เลือกพัด ใบมีด-ไค้ถ่านไอเทม*	1170040059+1170100027	CALL
	Axial Flow Fan (Fan Disk) (028-1857)	1070030012	1,100
	Compressor QJ208PHA	CALL	
	Condenser Coil (1110060406)	70-COIL0014	CALL

Outdoor Triple E Model TTK515DB5E01

	PART NAME	P/N	LIST PRICE
	Outdoor Motor (024-1008) *เลือกพัด ใบมีด-ไค้ถ่านไอเทม*	1170040059+1170100027	CALL
	Axial Flow Fan (Fan Disk) (028-1857)	1070030012	1,100
	Compressor QJ222PEA	CALL	
	Condenser Coil (1110060406)	70-COIL0014	CALL

Outdoor Triple E Model TTK518DB5E01

	PART NAME	P/N	LIST PRICE
	Outdoor Motor (024-1011) *เลือกพัด ใบมีด-ไค้ถ่านไอเทม*	1170040105+1170100030	CALL
	Axial Flow Fan (Fan Disk) (028-1886) *เลือกพัด ใบมีด-ไค้ถ่านไอเทม*	70-FAN00003	CALL
	Compressor PH28VSET	CALL	
	Condenser Coil (1110060467)	70-COIL0039	CALL

Outdoor Triple E Model TTK518DB5E11

	PART NAME	P/N	LIST PRICE
	Outdoor Motor (024-1011) *เลือกพัด ใบมีด-ไค้ถ่านไอเทม*	1170040105+1170100030	CALL
	Axial Flow Fan (Fan Disk) (028-1886) *เลือกพัด ใบมีด-ไค้ถ่านไอเทม*	70-FAN00003	CALL
	Compressor QP306PAA	CALL	
	Condenser Coil (1110060467)	70-COIL0039	CALL

Outdoor Triple E Model TTK524MB0EEA

	PART NAME	P/N	LIST PRICE
	Outdoor Motor	70-MOT00037	2,000
	Axial Flow Fan	028-1283	1,200
	Compressor PH41VPYT	015-0299	9,800
	Condenser Coil	026-2507	11,400

Parts List Hi-Wall (DX-COIL) MCW 30,000-36,000 BTUH MCW---6B



Indoor 30,000BTU Model M C W 5 3 0 6 B A 0 0

	PART NAME	P/N	LIST PRICE
	Remote Controller	024-0498-001	1,400
	Indoor Fan Motor	E137+E56	4,800
	Main Control Board	ET700	3,500
	Receiver Board	ET110	1,200
	Stepping Motor	E57	700
	Filter *ใช้ 2 ชั้นต่อเครื่อง	P183-1	500
	Cross Flow Fan (Blower)	P194	2,900
	Temperature Sensor (ET103)	70-SENS0013	500
	Freeze Sensor (ET106)	70-SENS0014	500
	Evaporator Coil	DD090001CA	10,800
	Drain Pan Assy	PP0514PA	3,000
	Front Panel	P244	3,000
	Frame Front (P177)	PP0515	3,600
	Installation Plate	FF110503	1,800

Indoor 30,000BTU Model M C W 5 3 0 6 B A 0 1

	PART NAME	P/N	LIST PRICE
	Remote Controller	024-1065	2,000
	Indoor Fan Motor	E137+E56	4,800
	Main Control Board (ET80002)	70-BRD00008	3,500
	Receiver Board	ET110	1,200
	Stepping Motor	E57	700
	Filter *ใช้ 2 ชั้นต่อเครื่อง	P183-1	500
	Cross Flow Fan (Blower)	P194	2,900
	Temperature Sensor (ET103)	70-SENS0013	500
	Freeze Sensor (ET106)	70-SENS0014	500
	Evaporator Coil	DD090001CA	10,800
	Drain Pan Assy	PP0514PA	3,000
	Front Panel	P244	3,000
	Frame Front (P177)	PP0515	3,600
	Installation Plate	FF110503	1,800

1



Indoor 30,000BTU Model M C W 5 3 0 6 B 0 A 1 0

	PART NAME	P/N	LIST PRICE
	Remote Controller	024-1065	2,000
	Indoor Fan Motor (E137+E7)	E137+690424950001	4,800
	Main Control Board (ET080002)	70-BRD00008	3,500
	Receiver Board (ET131)	70-BRD00007	1,200
	Stepping Motor	E57	700
	Filter LH (P379-1)	690404090001	500
	Filter RH (P395-1)	690404100001	500
	Cross Flow Fan (Blower)	PP080518	2,900
	Temperature Sensor (ET103)	70-SENS0013	500
	Freeze Sensor (ET106)	70-SENS0014	500
	Evaporator Coil	DD090001CA	10,800
	Drain Pan Assy (PP090504PA)	690400520001	3,000
	Front Panel (PP080507)	690413570001	3,000
	Frame Front (PP080513)	690416020001	3,600
	Installation Plate (F97)	690405100001	1,800

Indoor 30,000BTU Model M C W 5 3 0 6 B 5 A 0 0

	PART NAME	P/N	LIST PRICE
	Remote Controller	024-1065	2,000
	Indoor Fan Motor	E606+E95	4,800
	Main Control Board (ET080002)	70-BRD00008	3,500
	Receiver Board (ET142)	70-BRD00027	1,200
	Stepping Motor	E57	700
	Filter (P628-1) *ใช้ 2 ชั้นต่อเครื่อง	026-2439	500
	Cross Flow Fan (Blower) Left	P612	2,300
	Cross Flow Fan (Blower) Right	P613	2,300
	Temperature Sensor (ET103)	70-SENS0013	500
	Freeze Sensor (ET106)	70-SENS0014	500
	Evaporator Coil (DD080001CA)	690410230001	12,000
	Drain Pan Assy (PP080628PA)	70-DRAN0012	3,900
	Front Panel	PP080613	4,200
	Frame Front (PP0615)	690416780001	4,200
	Installation Plate (F600)	70-OTHR0216	2,400

HI-WALL PARTS LIST



1

Indoor 36,000BTU Model M C W 5 3 6 6 B A 0 0

	PART NAME	P/N	LIST PRICE
	Remote Controller	024-1065	2,000
	Indoor Fan Motor	E606+E95	4,800
	Main Control Board (ET080002)	70-BRD00008	3,500
	Receiver Board (ET142)	70-BRD00027	1,200
	Stepping Motor	E57	700
	Filter (P628-1) *ใช้ 2 ชั้นต่อเครื่อง	026-2439	500
	Cross Flow Fan (Blower) Left	P612	2,300
	Cross Flow Fan (Blower) Right	P613	2,300
	Temperature Sensor (ET103)	70-SENS0013	500
	Freeze Sensor (ET106)	70-SENS0014	500
	Evaporator Coil (DD080001CA)	690410230001	12,000
	Drain Pan Assy (PP080628PA)	70-DRAN0012	3,900
	Front Panel	PP080613	4,200
	Frame Front (PP0615)	690416780001	4,200
	Installation Plate (F600)	70-OTHR0216	2,400

Indoor 36,000BTU Model M C W 5 3 6 6 B 0 A 0 0 / M C W 5 3 6 6 B 0 A 0 1

	PART NAME	P/N	LIST PRICE
	Remote Controller	024-1065	2,000
	Indoor Fan Motor	E606+E95	4,800
	Main Control Board (ET080002)	70-BRD00008	3,500
	Receiver Board (ET142)	70-BRD00027	1,200
	Stepping Motor	E57	700
	Filter (P628-1) *ใช้ 2 ชั้นต่อเครื่อง	026-2439	500
	Cross Flow Fan (Blower) Left	P612	2,300
	Cross Flow Fan (Blower) Right	P613	2,300
	Temperature Sensor (ET103)	70-SENS0013	500
	Freeze Sensor (ET106)	70-SENS0014	500
	Evaporator Coil (DD080001CA)	690410230001	12,000
	Drain Pan Assy (PP080628PA)	70-DRAN0012	3,900
	Front Panel	PP080613	4,200
	Frame Front (PP0615)	690416780001	4,200
	Installation Plate (F600)	70-OTHR0216	2,400

Indoor 30,000BTU (R-410A) Model M C W A 3 0 6 B 0 A 0 0

	PART NAME	P/N	LIST PRICE
	Remote Controller	024-1065	2,000
	Indoor Fan Motor	E606+E95	4,800
	Main Board (ET1210001)	690419470001	3,500
	Receiver Board (ET131)	70-BRD00007	1,200
	Stepping Motor	E57	700
	Filter LH	P379-1-W	500
	Filter RH	P395-1-W	500
	Cross Flow Fan (Blower)	PP080518	2,900
	Temperature Sensor (ET103)	70-SENS0013	500
	Freeze Sensor (ET106)	70-SENS0014	500
	Evaporator Coil	DD090001CA	10,800
	Drain Pan Assy	PP0514PA	3,000
	Front Panel	PP080507-W	3,000
	Frame Front	P373-W	3,600
Installation Plate	FF110503	1,800	

Indoor 30,000BTU (R-410A) Model M C W A 3 0 6 B 5 A 0 0

	PART NAME	P/N	LIST PRICE
	Remote Controller	024-1065	2,000
	Indoor Fan Motor	E137+E56	4,800
	Main Board (ET1210001)	690419470001	3,500
	Receiver Board (ET142)	70-BRD00027	1,200
	Stepping Motor	E57	700
	Filter *ใช้ 2 ชั้นต่อเครื่อง	P628-1-W	500
	Cross Flow Fan (Blower) Left (PP100610)	690419650001	2,600
	Cross Flow Fan (Blower) Right (PP100611)	690419690001	2,600
	Temperature Sensor (ET103)	70-SENS0013	500
	Freeze Sensor (ET106)	70-SENS0014	500
	Evaporator Coil	DD160013CA	12,000
	Drain Pan Assy (PP080628PA)	70-DRAN0012	3,900
	Front Panel	PP080613-W	4,800
	Frame Front	PP0615-W	4,200
Installation Plate (FF100604)	690417930001	2,400	

Indoor 36,000BTU (R-410A) Model M C W A 3 6 6 B 0 A 0 0

	PART NAME	P/N	LIST PRICE
	Remote Controller	024-1065	2,000
	Indoor Fan Motor	E606+E95	4,800
	Main Board (ET1210001)	690419470001	3,500
	Receiver Board (ET142)	70-BRD00027	1,200
	Stepping Motor	E57	700
	Filter *ใช้ 2 ชั้นต่อเครื่อง	P628-1-W	500
	Cross Flow Fan (Blower) Left	P612	2,300
	Cross Flow Fan (Blower) Right	P613	2,300
	Temperature Sensor (ET103)	70-SENS0013	500
	Freeze Sensor (ET106)	70-SENS0014	500
	Evaporator Coil (DD080001CA)	690410230001	12,000
	Drain Pan Assy (PP080628PA)	70-DRAN0012	3,900
	Front Panel	PP080613-W	4,800
	Frame Front	PP0615-W	4,200
	Installation Plate (FF100604)	690417930001	2,400

Indoor 30,000BTU (R-32) Model M C W E 3 0 6 B 0 A 0 0

	PART NAME	P/N	LIST PRICE
	Remote Controller	024-1065	2,000
	Indoor Fan Motor	E606+E95	4,800
	Main Board	ET170011	3,600
	Receiver Board (ET131)	70-BRD00007	1,200
	Stepping Motor	E57	700
	Filter LH	P379-1-W	500
	Filter RH	P395-1-W	500
	Cross Flow Fan (Blower)	PP080518	2,900
	Temperature Sensor (ET103)	70-SENS0013	500
	Freeze Sensor (ET106)	70-SENS0014	500
	Evaporator Coil	DD090001CA	10,800
	Drain Pan Assy	PP0514PA	3,000
	Front Panel	PP080507-W	3,000
	Frame Front	PP0505-W	3,600
	Installation Plate	FF110503	1,800

Indoor 30,000BTU (R-32) Model M C W E 3 0 6 B 5 A 0 0

	PART NAME	P/N	LIST PRICE
	Remote Controller	024-1065	2,000
	Indoor Fan Motor (E137+E7)	E137+690424950001	4,800
	Main Board (ET170012)	690426580001	3,600
	Receiver Board (ET142)	70-BRD00027	1,200
	Stepping Motor	E57	700
	Filter *ใช้ 2 ชั้นต่อเครื่อง	P628-1-W	500
	Cross Flow Fan (Blower) Left (PP100610)	690419650001	2,600
	Cross Flow Fan (Blower) Right (PP100611)	690419690001	2,600
	Temperature Sensor (ET103)	70-SENS0013	500
	Freeze Sensor (ET106)	70-SENS0014	500
	Evaporator Coil	DD190004CA	12,000
	Drain Pan Assy	PP190611PA	3,900
	Front Panel	PP080613-W	4,800
	Frame Front	PP090632	4,200
Installation Plate (FF100604)	690417930001	2,400	

Indoor 36,000BTU (R-32) Model M C W E 3 6 6 B 0 A 0 0

	PART NAME	P/N	LIST PRICE
	Remote Controller	024-1065	2,000
	Indoor Fan Motor	E606+E95	4,800
	Main Board (ET170012)	690426580001	3,600
	Receiver Board (ET142)	70-BRD00027	1,200
	Stepping Motor	E57	700
	Filter *ใช้ 2 ชั้นต่อเครื่อง	P628-1-W	500
	Cross Flow Fan (Blower) Left	P612	2,300
	Cross Flow Fan (Blower) Right	P613	2,300
	Temperature Sensor (ET103)	70-SENS0013	500
	Freeze Sensor (ET106)	70-SENS0014	500
	Evaporator Coil	DD190003CA	12,000
	Drain Pan Assy	PP190611PA	3,900
	Front Panel	PP080613-W	4,800
	Frame Front	PP090632	4,200
Installation Plate (FF100604)	690417930001	2,400	

Parts List TTK_CB COOL PLUS

1

Outdoor Cool-Plus 12,000 BTU/HR Unit Model TTK512CB50AA

	PART NAME	P/N	LIST PRICE
	Axial Flow Fan	10333004	1,100
	Fan Motor FW35X	150130676	2,100
	Compressor	00103260G	CALL
	Condenser Coil (01113492K44579)	70-COIL0029	10,800

Outdoor Cool-Plus 12,000 BTU/HR Unit Model TTK512CB50BA

	PART NAME	P/N	LIST PRICE
	Axial Flow Fan	10333004	1,100
	Fan Motor FW35X	150130676	2,100
	Compressor	00103262G	CALL
	Condenser Coil (1113958)	70-COIL0032	10,800

Outdoor Cool-Plus 18,000 BTU/HR Unit Model TTK518CB50AA

	PART NAME	P/N	LIST PRICE
	Axial Flow Fan	10335008	1,400
	Fan Motor LW60J	1501506102	3,000
	Compressor	00103132G	CALL
	Condenser Coil (01113511K44579)	70-COIL0030	15,600

Outdoor Cool-Plus 18,000 BTU/HR Unit Model TTK518CB50BA

	PART NAME	P/N	LIST PRICE
	Axial Flow Fan	10335008	1,400
	Fan Motor LW60J	1501506102	3,000
	Compressor	00105037G	CALL
	Condenser Coil (1163890)	70-COIL0034	15,600

Parts List TTKE_HB FOR MCDE/MCXE/MCCE < 24,000 BTU/H

Outdoor TTKE for MCDE/MCXE 12,000 BTU/HR Unit Model TTKE12HB5EAA

	PART NAME	P/N	LIST PRICE
	Axial Flow Fan (10333427)	690412770001	1,100
	Fan Motor FW35X	150130676	2,100
	Compressor	CALL	
	Condenser Coil (011002000073)	690413470001	7,000

Outdoor TTKE for MCDE/MCXE/MCCE 18,000 BTU/HR Unit Model TTKE18HB5EAA

	PART NAME	P/N	LIST PRICE
	Axial Flow Fan (10333016)	690412750001	1,400
	Fan Motor LW40B (15013075)	690412720001	3,600
	Compressor	CALL	
	Condenser Coil (01100200676)	690416540001	9,000

Outdoor TTKE for MCDE/MCXE/MCCE 24,000 BTU/HR Unit Model TTKE24HB5EAA

	PART NAME	P/N	LIST PRICE
	Axial Flow Fan (10333023)	690412760001	1,400
	Fan Motor LW50G (15015068)	690412730001	3,600
	Compressor	CALL	
	Condenser Coil (01100200671)	690416550001	14,400

Parts List Hi-Wall (WATER COIL) HWCF

HWCF03-12A10R00



Indoor HWCF 300 CFM Model HWCF03A10R00

	PART NAME	P/N	LIST PRICE
	Remote Control (ET10011)	690407020001	2,000
	Indoor Motor (E71+E91)	690424770001+690405910001	3,600
	Main Board	ET1210001	3,600
	Display Board (ET090003)	690420940001	1,200
	Stepping Motor	E57	700
	Filter Sub-Assy *ใช้ 2 ชั้นต่อเครื่อง	PP120106-W	500
	Cross Flow Fan (Blower)	P509	3,000
	Temperature Sensor (ET103)	70-SENS0013	500
	Freeze Sensor (ET106)	70-SENS0014	500
	Evaporator Coil	DW0009CA	10,800
	Drain Pan Assy	PP0105PA	2,400
	Front Panel	PP130101-W	2,400
	Frame Front	PP080103-W	4,200
Installation Plate	F110101	1,800	

Indoor HWCF 400 CFM Model HWCF04A10R00

	PART NAME	P/N	LIST PRICE
	Remote Control (ET10011)	690407020001	2,000
	Indoor Motor (E71+E91)	690424770001+690405910001	3,600
	Main Board (ET100005)	690405380001	3,600
	Display Board (ET090003)	690420940001	1,200
	Stepping Motor	E57	700
	Filter Sub-Assy *ใช้ 2 ชั้นต่อเครื่อง	PP080107-1	500
	Cross Flow Fan (Blower) (P199)	690403560001	3,000
	Temperature Sensor (ET103)	70-SENS0013	500
	Freeze Sensor (ET106)	70-SENS0014	500
	Evaporator Coil	DW0010CA	10,800
	Drain Pan Assy	PP0204PA	2,400
	Front Panel	PP090205	2,400
	Frame Front	PP090206	3,600
Installation Plate	FF110201	1,800	

Indoor HWCF 600 CFM Model HWCF06A10R00

	PART NAME	P/N	LIST PRICE
	Remote Control (ET10011)	690407020001	2,000
	Indoor Motor	E55+E95	4,200
	Main Board (ET100005)	690405380001	3,600
	Display Board (ET080008)	690419110001	1,200
	Stepping Motor	E57	700
	Filter Sub-Assy LH (P379-1)	690404090001	500
	Filter Sub-Assy RH (P395-1)	690404100001	500
	Cross Flow Fan (Blower)	P194	2,900
	Temperature Sensor (ET103)	70-SENS0013	500
	Freeze Sensor (ET106)	70-SENS0014	500
	Evaporator Coil	DW0011CA	10,800
	Drain Pan Assy	PP110501PA	3,000
	Front Panel (PP080507)	690413570001	3,000
	Frame Front	PP0505	3,600
	Installation Plate	FF110503	1,800

Indoor HWCF 800 CFM Model HWCF08A10R00

	PART NAME	P/N	LIST PRICE
	Remote Control (ET10011)	690407020001	2,000
	Indoor Motor	E55+E95	4,200
	Main Board (ET100005)	690405380001	3,600
	Display Board (ET080008)	690419110001	1,200
	Stepping Motor	E57	700
	Filter Sub-Assy LH (P379-1)	690404090001	500
	Filter Sub-Assy RH (P395-1)	690404100001	500
	Cross Flow Fan (Blower)	P194	2,900
	Temperature Sensor (ET103)	70-SENS0013	500
	Freeze Sensor (ET106)	70-SENS0014	500
	Evaporator Coil	DW12	10,800
	Drain Pan Assy	PP0514PA	3,000
	Front Panel (PP080507)	690413570001	3,000
	Frame Front	PP0505	3,600
	Installation Plate	FF110503	1,800

Indoor HWCF 1000 CFM Model HWCF10A10R00

	PART NAME	P/N	LIST PRICE
	Remote Control (ET10011)	690407020001	2,000
	Indoor Motor	E137+E56	4,800
	Main Board (ET100005)	690405380001	3,600
	Display Board (ET080008)	690419110001	1,200
	Stepping Motor	E57	700
	Filter Sub-Assy (P628-1) *ใช้ 2 ชั้นต่อเครื่อง	026-2439	500
	Cross Flow Fan (Blower) LH	P612	2,300
	Cross Flow Fan (Blower) RH	P613	2,300
	Temperature Sensor (ET103)	70-SENS0013	500
	Freeze Sensor (ET106)	70-SENS0014	500
	Evaporator Coil	DW08	12,000
	Drain Pan Assy	PP090624PA	4,200
	Front Panel	PP080613	4,200
	Frame Front (PP0615)	690416780001	4,200
Installation Plate (FF100604)	690417930001	2,400	

Indoor HWCF 1200 CFM Model HWCF12A10R00

	PART NAME	P/N	LIST PRICE
	Remote Control (ET10011)	690407020001	2,000
	Indoor Motor	E606+E95	4,800
	Main Board (ET100005)	690405380001	3,600
	Display Board (ET080008)	690419110001	1,200
	Stepping Motor	E57	700
	Filter Sub-Assy (P628-1) *ใช้ 2 ชั้นต่อเครื่อง	026-2439	500
	Cross Flow Fan (Blower) LH	P612	2,300
	Cross Flow Fan (Blower) RH	P613	2,300
	Temperature Sensor (ET103)	70-SENS0013	500
	Freeze Sensor (ET106)	70-SENS0014	500
	Evaporator Coil	DW13	12,000
	Drain Pan Assy	PP090624PA	4,200
	Front Panel	PP080613	4,200
	Frame Front (PP0615)	690416780001	4,200
Installation Plate (FF100604)	690417930001	2,400	

Trane Refrigeration Filter Driers



MODEL	P/N	SIZE	TONS	LIST PRICE
TSD053 FOR TTK512-536	690405790001	3/8"	3	1,100
TSD083 FOR TTK042	690405800001	3/8"	4	800
TSD084 FOR TTK048-060	690405810001	1/2"	5	800
CD9-164S FOR TTA075	026-3009-5	1/2"	7.5	1,100
CD9-165S FOR TTA100,200	026-3011-5	5/8"	10	1,400
CD9-304S	026-3005-5	1/2"	7.5	CALL
CD9-305S	026-3013-5	5/8"	15	CALL
CD9-307S	026-3017-5	7/8"	20	CALL
DCL-757S FOR RAUP, SOLDER (026-2188)	690427680001	7/8"	30	4,600

Trane Sight Glass



MODEL	P/N	SIZE	ชนิด	LIST PRICE
TSG-3	026-4001-1	3/8	เชื่อม	CALL
TSG-4	026-4002-1	1/2	เชื่อม	CALL
TSG-5	026-4004-1	5/8	เชื่อม	CALL
TSG-7	026-4003-1	7/8	เชื่อม	CALL

Condensate Drain Pump



SERIES	DESCRIPTION	P/N	LIST PRICE
(Old) Cassette, Cassette Water Coil	Drain Pump w/ floating switch for MCC518-536AB, CWS06-14 (031100640)	0307101100790A	4,700
	Floating Switch for drain pump MCC518-536AB, CWS06-14	0307001100750	600
Cassette, 1-Way Cassette	Drain Pump for MCC518-5361B, MCA, CWAA (025-0674)	690427400001	4,200
(New) Cassette	Drain Pump for MCC518-5422B MCCA18-602B, MCCE18-E602B, CWS-2 (999-0250749)	690427810001	4,200
Cassette (Water Coil)	Drain Pump w/ floating switch for CWS03-06 7A (0307101100740A)	690413670001	4,700
	Drain Pump w/ floating switch for CWS16, CWS08-16 7A (0307101100745A,0307101100743A)	690424990001	4,700
	Floating Switch for drain pump CWS016, CWS03-16 7A (0307001100760)	690411460001	700
SI3300 (SI-33)	Drain Pump Max. flow 30l/h, Max. discharge head 13 m., Max. suction head 4 m. 230V~ 50/60Hz -21 W **โปรดศึกษาวิธีการเลือกขนาดปั๊มเพื่อการใช้งานที่เหมาะสม** **แนะนำ สำหรับเครื่องขนาดไม่เกิน 36,000 BTU/H**	70-CONS0001	6,400
FP2210 (MAXI ORANGE)	Drain Pump Max. Flow 35 l/h@head 0m. Max. rec. head 15m., Max. suction lift 2m. 230V AC 50-60Hz 0.1A, 46kW **โปรดศึกษาวิธีการเลือกขนาดปั๊มเพื่อการใช้งานที่เหมาะสม** **แนะนำ สำหรับเครื่องขนาดไม่เกิน 60,000 BTU/H**	690406510001	6,100
FP1080/2 (MINI BLANC)	Drain Pump Max. Flow 12 l/h@head 0m. Max. rec. head 10m. 230V~50Hz-60Hz - 0.11A, 19W **โปรดศึกษาวิธีการเลือกขนาดปั๊มเพื่อการใช้งานที่เหมาะสม** **แนะนำ สำหรับเครื่องขนาดไม่เกิน 36,000 BTU/H**	690413740001	5,300
FP3349 (MAX HI FLOW)	Drain Pump Max. Flow 550 l/h, Max. discharge head 5 m. 230V~50Hz - 0.8A **โปรดศึกษาวิธีการเลือกขนาดปั๊มเพื่อการใช้งานที่เหมาะสม**	690412210001	5,500



หมายเหตุ : ปริมาณน้ำทิ้งประมาณ 1.8 - 2.8 ลิตรต่อชั่วโมง (l/h) ต่อเครื่องปรับอากาศ 1 ตัน

maxi orange

CONDENSATE REMOVAL PUMP



- 35L/h max. flow
- 15m max. rec. head (flow rate 10L/h)
- 35dB(A)

KEY FEATURES

- High power motor
- Superior performance
- Submersible secondary reservoir included

ข้อมูลทางเทคนิค

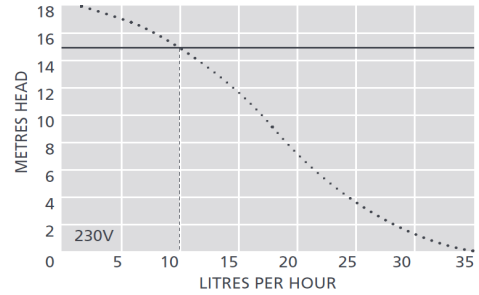

MAXI ORANGE SPECIFICATIONS

Max. flow	35L/h @ 0 head
Max. rec. head	15m
Max. suction lift	2m
Sound level@1m	35dB(A)
Power supply	230V AC 50-60Hz 0.1A*
Rated	Non continuous
Class	II appliance <input type="checkbox"/>
Max. unit output	41.4kW / 141,300Btu/h
Max. water temp	40°C / 104°F
Discharge tube	6mm ID
IP Protection	IPX1
Safety switch	3.0A Normally closed
Thermal protection	✓
Fully potted	✓
Self priming	✓

อุปกรณ์ภายในกล่อง

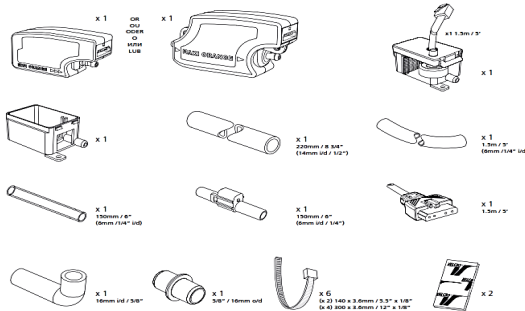

การติดตั้งปั้มน้ำ

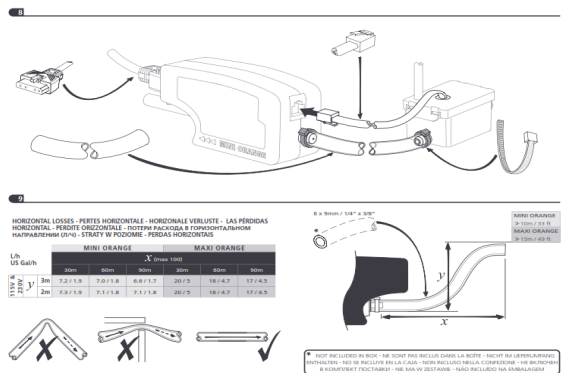

การติดตั้งลูกลอย

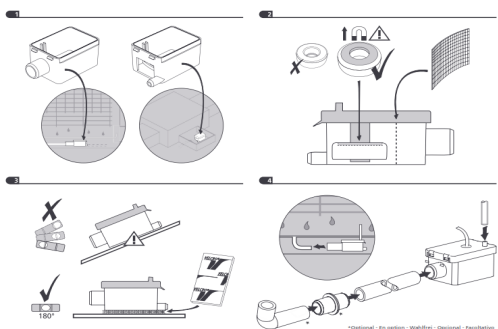

การต่อสายไฟ

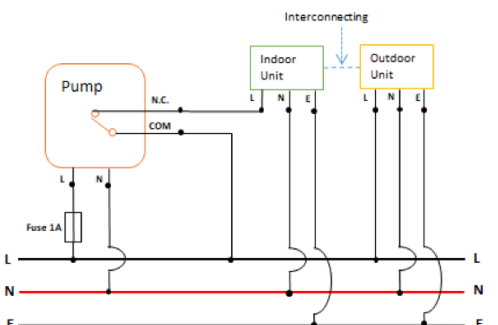

ภาพรวมการติดตั้ง



ตารางคำนวณอัตราการใช้น้ำที่จริง (Actual flow rate: l/h) ตามระยะดูดและระยะอัด ของปั๊มรุ่น SI3300

(A) ระยะดูดแนวตั้ง (Suction Head)	(B) ระยะอัดแนวตั้ง (Vertical Discharge Head)	(C) ระยะความยาวรวมแนวนอน (Total tube length – øint. 6 mm (1/4”) hose)			
		5 m	10 m	20 m	30 m
0 m	0 m	30	27	26	25
	2 m	26	24	23	22
	4 m	22	21	20	19
	6 m		18	17	16
	8 m		15	14	13
	10 m		12	11	10
	12 m			8	7
1 m	0 m	24	23	22	21
	2 m	20	19	18	17
	4 m	17	16	15	14
	6 m		13	12	11
	8 m		10	9	8
	10 m		6	5	
2 m	0 m	21	20	19	18
	2 m	17	16	15	14
	4 m	14	13	12	11
	6 m		10	9	8
	8 m		7	6	5
3 m	0 m	18	17	16	15
	2 m	15	14	13	12
	4 m		10	9	8
	6 m		6	5	4

ต.ย. เครื่องขนาด 5 ตัน มีปริมาณน้ำถึงสูงสุดที่ $2.8 \times 5 = 14$ ลิตร/ชม.

ที่ระยะติดตั้งจริง มีระยะดูดแนวตั้ง 2 เมตร ระยะอัดแนวตั้ง 4 เมตร และเดินท่อแนวนอนยาว 10 เมตร จากตาราง ปั๊มรองรับน้ำถึงได้ 13 ลิตร/ชม.

สรุป : ไม่พอสำหรับปริมาณน้ำถึงสูงสุดที่ 14 ลิตร/ชม. ดังนั้นต้องเลือกปั๊มที่มีขนาดใหญ่ขึ้น

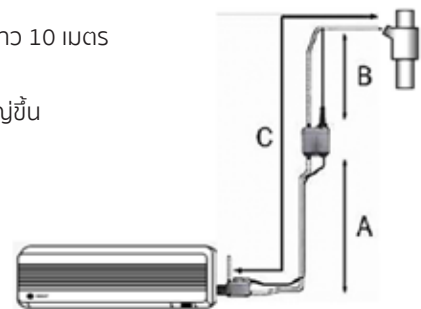

sauerermann®

TRANE
HVAC Parts & Supplies

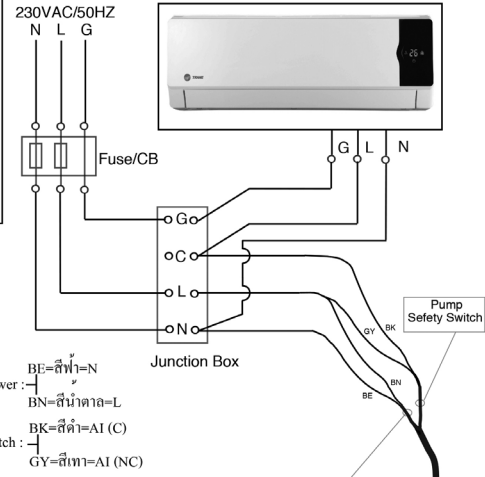
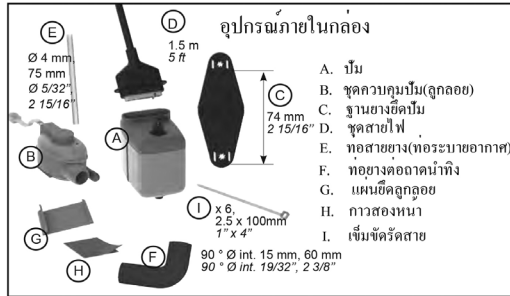

ข้อมูลทางเทคนิค

Max flow rate	30 l/h (8 gph)
Max suction head	4 m (13 ft)
Max discharge head	13 m (43 ft)
Voltage *	230 V-50/60Hz - 21 W or 120V-60Hz - 21W or 208 - 230V-50/60Hz - 21W
Safety switch	NC 6A resistive - 250 V
Thermal protection (overheating)	90° C (194°F)
Detection levels	On: 16 mm Off: 11 mm Al: 19 mm (On=5/8" Off=7/16" Al.=3/4")
Sound level at 1m (3.3 ft)	34 dBA
Safety standards*	CE or UL / CSA certified by Intertek

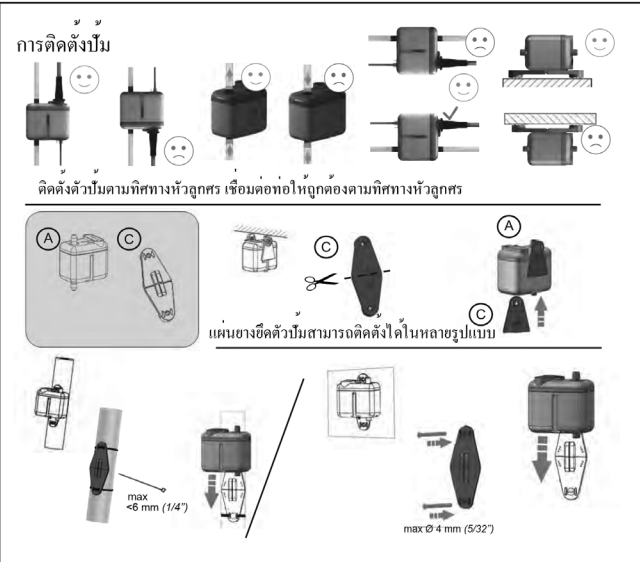
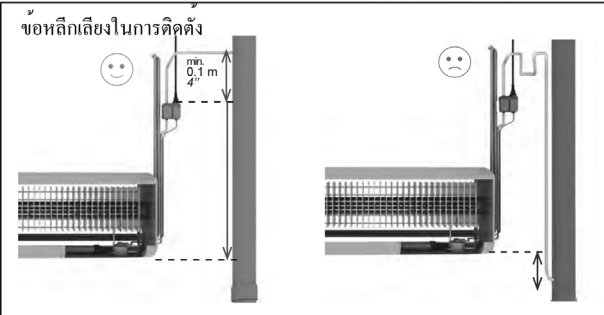
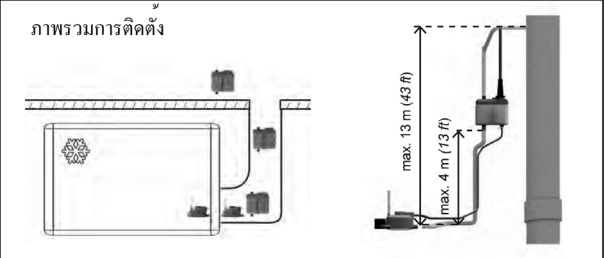
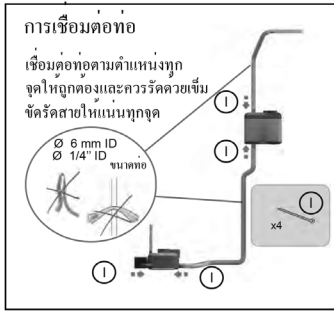

mini blanc®

CONDENSATE REMOVAL PUMP



The 'ultra quick fit' Mini Blanc is designed to be fitted beneath high wall indoor units and offers easy access for future maintenance.

12L/h max. flow

10m max. rec. head
(flow rate 4L/h)

21dB(A)

KEY FEATURES

- Extra quick to fit
- Compact & discreet
- Clear removable reservoir
- Ultra quiet operation

SUITABILITY

- Up to 16kW / 54,000Btu/h
- High wall mini split systems
- **Perfect for...** Domestic use – where easy maintenance is key

ข้อมูลทางเทคนิค

MINI BLANC SPECIFICATIONS	
Max. flow	12L/h @ 0 head
Max. rec. head	10m
Tank capacity	0.24L
Sound level@1m	21dB(A)
Power supply	230 VAC 0.11A, 19W 50/60Hz
Rated	Non continuous
Class	II appliance
Max. unit output	16kW / 54,000Btu/h
Max. water temp	40°C / 104°F
Inlet/outlet	20mm in, 6mm out
IP Protection	IP21
Safety switch	3.0A Normally closed
Thermal protection	✓
Fully potted	Partially
Self priming	✓

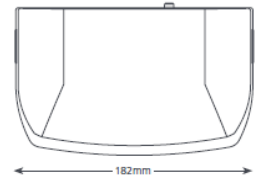
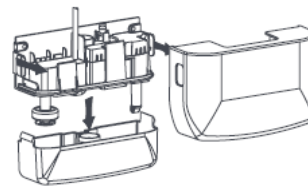
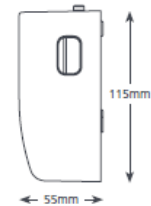
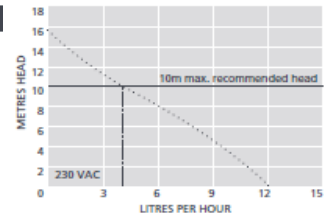

Information correct at time of going to press.

อุปกรณ์ภายในกล่อง

IN THE BOX

Mini Blanc pump (including hard wired 1m power cable) • Anti siphon device • Drain connector kit • Fixing kit • Install manual

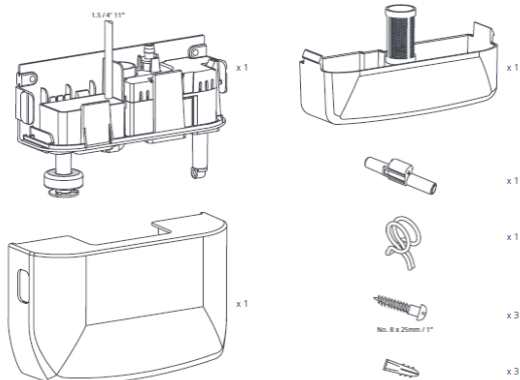

การต่อสายไฟ

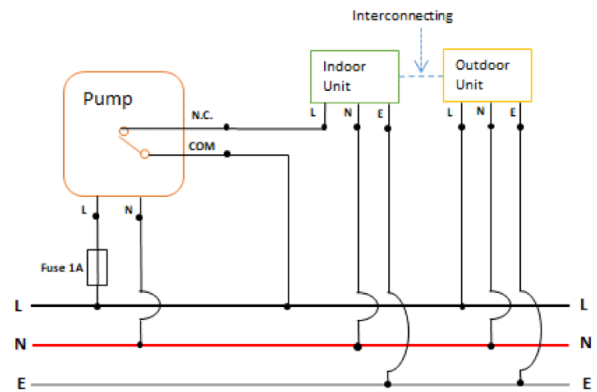

การติดตั้งบีมหน้า 1

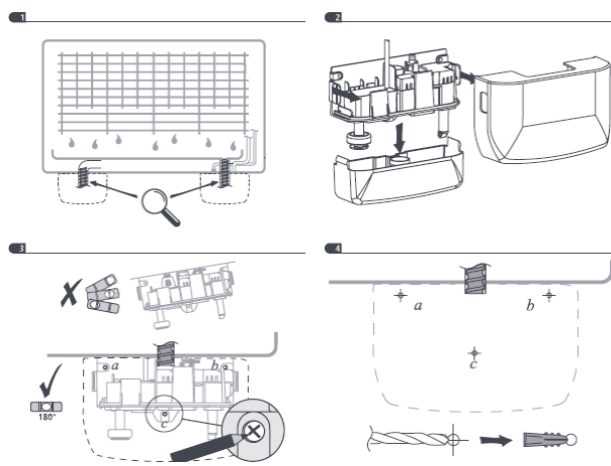

การติดตั้งบีมหน้า 2

