



Product Catalog

Trane Agility™ Water-cooled Liquid Chillers

150–450 Tons (615–1495 kW), 60 and 50 Hz



Model: HDWA
PC 747



Introduction

Compact Chillers That Fit Your Needs

Compact—Providing best-in-class size, the Agility™ chiller portfolio provides an optimized footprint that minimizes installation costs making it an ideal choice for existing building applications. The Agility™ chiller fits through a standard double door (72 inch x 80 inch) fully assembled, and can be easily separated into two sections that fit through a single door (36 inch x 80 inch).

Economical—The Agility™ chiller balances size and efficiency, allowing you to increase building efficiency while keeping installation costs low. Leveraging oil-free, magnetic bearings with optimized compressor speeds and the latest Trane® proprietary (CHIL™) heat exchanger designs, these technologies—coupled with proven chiller design principles—enable a smaller footprint, delivering both high full-load and Integrated Part Load Values (IPLV) over 40 percent better than the ASHRAE 90.1-2016. The Agility™ chiller's compact size will keep installation costs low, and its efficiency will help reduce electrical consumption (kWh or part load) as well as demand charges (kWh or high load) contributing to low operating expenses.

Reliable—The Agility™ chiller has legendary Trane® reliability designed in from the start. Its two-stage, semi-hermetic centrifugal compressor with a permanent magnet, refrigerant-cooled motor delivers efficient, stable operation across a wide range of applications. Couple this with Tracer® AdaptiView™ unit controls and customers will enjoy maximum flexibility to meet your applications' needs. Trane® controls also allow for remote connectivity, enabling optimum unit performance to deliver reliable and efficient operation. All of this is backed by factory available extended warranties with coverage up to and including 10 years for parts, labor and refrigerant—truly covering the whole chiller.

Environmental—The Agility™ chiller's design is optimized with the next-generation, low-GWP refrigerant R-513A in mind. This refrigerant provides a 55 percent reduction in GWP over R-134a helping you meet sustainability goals by reducing the impact to the environment. The Agility™ chiller can also be selected with R-134a refrigerant.

EcoWise™ Portfolio—Trane has always taken a leadership position in environmental stewardship without compromising efficiency, reliability or safety. Agility™ chillers are among the Trane® products within the EcoWise™ portfolio and can operate with either R-134a or the next-generation refrigerants R-513A, featuring a GWP 55 percent lower than R-134a. For more information, visit: trane.com/ecowise

Copyright

This document and the information in it are the property of Trane, and may not be used or reproduced in whole or in part without written permission. Trane reserves the right to revise this publication at any time, and to make changes to its content without obligation to notify any person of such revision or change.

Trademarks

All trademarks referenced in this document are the trademarks of their respective owners.



Table of Contents

- General Information 5
 - Local Support 5
 - ISO 9001 Certified..... 5
 - Certified AHRI Performance..... 5
 - Standard Features 5
 - Optional Features 7
- Application and Job Site Considerations..... 9
 - Low Condenser Water Temperatures 9
 - Water Treatment..... 9
 - Water Flow Strategies..... 9
 - Shipment and Assembly 9
- Controls 10
 - Tracer AdaptiView Controller 10
 - Optional Enhanced Flow Management Package 11
 - Communications Interfaces..... 13
 - Building Automation and Chiller Plant Control 14
 - Standard Protections..... 15
 - Enhanced Condenser-Limit Control..... 17
 - Compressor-Discharge Refrigerant-Temperature Protection..... 17
- Chiller Selection 18
 - Performance 18
 - Fouling Factors 18
 - Unit Performance with Fluid Media Other Than Water 18
 - Flow Rate Limits 18
 - Full-Load and Part-Load Performance 18
 - myPLV Chiller Performance Evaluation Tool 19
- Unit Specifications—Imperial (I-P) and International System (SI) Units 20
 - Dimensions 20
 - Weights (lb) 21
- Unit Specifications—International System (SI) Units..... 23
 - Weights (kg)..... 23

Mechanical Specifications	24
Compressor-Motor.....	24
Evaporator-Condenser	24
Waterboxes	24
Economizer	24
Tracer AdaptiView Control Panel	24
Operating Data	25
Control Functions.....	25
Status Data.....	25
Safeties	25
Appendix A: Chiller Operating Cycles.....	27
Compressor Motor.....	27
Expansion Valve (Variable Orifice) Flow Control	27
Multiple Stages of Compression	27
Inlet Guide Vanes	27
Flash Economizer	27
Appendix B: Chiller Pressure-Enthalpy (P-H) Diagrams	28
Appendix C: Standard Conversions.....	29



General Information

Local Support

The performance and reliability of Agility™ chillers is backed by a team of knowledgeable engineers, HVAC systems specialists, and technical professionals. Your local Trane team will see you through the entire chiller bid process, from building analysis to equipment specification and through installation and commissioning.

ISO 9001 Certified

The quality management system used by the Trane Agility™ chiller manufacturing facility is the ISO 9001 Standard. This standard documents office, manufacturing, and testing procedures for maximum consistency in meeting or exceeding customer expectations. ISO 9001 requires extensive documentation on how quality assurance activities are managed, performed, and continuously monitored. Included in the system are verification checkpoints from the time the order is entered until final shipment. In addition, product development is subjected to formal planning, review, and validation.

Certified AHRI Performance

Agility™ chillers are rated within the scope of the Air-Conditioning, Heating & Refrigeration Institute (AHRI) Certification Program and display the AHRI Certified® mark as a visual confirmation of conformance to the certification sections of AHRI Standard 550/590 (I-P) and ANSI/AHRI Standard 551/591 (SI).

The applications in this catalog specifically excluded from the AHRI certification program are:

- Low temperature applications (below 36°F [2.2°C]), including ice storage
- Heat recovery and heat pump ratings
- Glycol and brines

Standard Features

The following features are provided as standard with all Trane Agility™ chillers:

Hybrid Variable Frequency Drive

Overview

Agility's factory-installed Variable Frequency Drive incorporates a unique dual cooling design that harnesses all the advantages of air and liquid cooled drives.

The air-cooling portion allows the drive to start up and cool down using only air that provides the benefit of reducing the impact of thermal cycling, which contributes to greater reliability. The liquid cooling portion mitigates derating caused by environmental factors and allows for a more compact design.

Standard Features

Agility's drive is separate from the compressor providing for easy access and serviceability. This means less maintenance costs over the life of the chiller.

Agility's unit controls are designed to allow for a wide-range of operating ranges and for the specific characteristics of the chiller. The control logic optimizes chiller efficiency by coordinating compressor motor speed and compressor inlet guide vane position to maintain the chilled water setpoint while avoiding surge.

- NEMA 1
- VFD enclosures capable of being padlocked
- Minimum short circuit withstand rating of 65,000 amps per UL 508A
- 120 volt, 60 hertz, 1-phase fused pilot and safety circuits
- Operating ambient temperature of 14°F—104°F (-10°C—40°C)



General Information

- Room ambient up to 95% relative humidity
- Control power transformer (3kVA) producing 120V, 60 and 50 Hz, single-phase. This provides auxiliary power for all chiller-mounted devices
- Three-phase incoming line terminals
- One pilot relay to initiate start sequence from Agility™ chiller control circuit signal

Standard Motor Protections

Trane provides the key motor protection and metering functions within the chiller microprocessor control panel as standard. Having the motor control and chiller control in one panel provides better integration and optimization of the two control systems. For example, the chiller controller can unload the chiller when approaching an overload “trip” point, so that the chiller stays online.

the standard motor protections include:

- Overload protection
- Long acceleration protection
- Motor overheat protection
- Momentary power loss protection (Distribution fault)
- Phase failure/loss protection
- Phase imbalance protection
- Phase reversal protection
- Under/over voltage protection
- Short cycling protection

Integrated UPS Backup System

With any magnetic bearing system, the Magnetic Bearing Controller (MBC) needs an alternative power supply in the advent of a power failure to safely shut down. Traditionally, magnetic bearing systems utilize the variable frequency drive capacitors as a backup power source. However, this exposes the MBC to the line side power subjecting it to power sags, spikes and other anomalies. As standard, all Agility chillers utilize an on-board uninterruptible Power Source (UPS) that not only provides back-up power to the MBC, but also protects it from line side anomalies.

Integrated Rapid Restart

***Note:** Restart times will vary depending on conditions at the time of power loss and how available power supplies are connected. Contact your local Trane account manager for more information.*

A loss of cooling capacity can be costly, which is why Agility chillers are designed to integrate seamlessly with uninterruptible power supplies (UPS) and provide responsive, rapid start-up capabilities to reduce downtime.

In the event of a power interruption, the chiller defaults to its rapid restart mode, optimizing electrical and mechanical variables, including guide vane position. This not only helps the chiller get back online faster, but it also provides the least amount of load on your building’s electrical infrastructure, which can make a big difference if your building has a backup generator.

Even under extreme conditions, Agility chiller restart times have been verified at as few as 45 seconds. Thanks to fast restart times like these, you can substantially minimize the risks of financially devastating damage to assets caused by overheating due to power outages.

Quiet Operation

Agility’s direct drive, magnetic bearing compressor provides quiet, reliable and efficient operation across its operating map. Agility chillers rank among the quietest chillers delivering sound levels at or below 79 dBA. When evaluating sound, it is important to understand the

conditions and measurement standard to calculate sound levels. Trane can guarantee sound levels with factor testing and measurements in accordance with AHRI Standard 1280.

Optional Features

Marine Water Boxes and Bolt-On Hinges

Agility offers water boxes for your specific application:

- Two-pass evaporator and condenser configurations
- Standard and marine available
- Victaulic® or welded raised face flanges
- Hinged water box options
- Belzona 1321 Ceramic Coating and anodes available

Thermal Insulation

Prevent condensation on the chiller shells:

- Available in two thicknesses: 0.75 inch (19 mm) and 1.5 inch (38 mm)
- Provides flexible thermal barrier
- Low VOCs, fiber free and resistant to mold

Enhanced Flow Management

Maintain stable, precise, capacity control:

- Operate chiller at greater variable evaporator flows
- Tighten leaving temperature control
- Minimize variable-flow disturbance
- Maintain control stability at low flow

Factory Performance Testing

Agility™ chillers that fall within the scope of the AHRI Standard 550/590 (I-P) and ANSI/AHRI Standard 551/591 (SI) Certification Process bear the AHRI seal. All other Agility™ chillers, and the selection software itself, are rated in accordance with the Standard. Performance testing is a key part of this program. Factory performance tests confirm that your chiller's actual performance matches what was predicted during the selection process, before the chiller is installed.

Standard AHRI tests are a well-recognized industry practice; however, a chiller's operating conditions vary significantly based on the needs of the building and its occupants. Data centers, hospitals, and retail locations all have specific requirements unique to their application and location. The Trane myTest™ program offers a fully customizable portfolio of chiller test packages and proof-of-performance options, in addition to standard AHRI tests. All tests and demonstrations are done in accordance with AHRI Standard 550/590, and the testing equipment is calibrated and validated by the National Institute of Standards Technology (NIST).

AHRI allows for standard tolerances in its certified selections; however, some customers may require tighter tolerances. Selecting and testing to zero tolerance requirements ensures that the full capacity and performance benefit are realized.

To learn more, contact your local Trane account manager or visit www.trane.com/myTest.

IEEE Standard 519 Harmonic Filter and Transformer Options

It is important to recognize that the IEEE Standard 519 as a guideline relates to the entire system, not specifically to any one load or product. IEEE Standard 519 establishes requirements at the point of common coupling (PCC) where the building connects to the utility system. The Standard contains no specific requirements for the internal electrical loads. Even though a Trane® VFD-equipped chiller may attenuate its own harmonics, other non-linear loads on the same system may still create harmonic problems. In buildings where harmonics might be a concern, Trane



General Information

recommends conducting a power-distribution system analysis to determine if there is a need to further attenuate harmonics at the system level.

The Agility™ chiller's standard Total Demand Distortion (TDD) is approximately 30%. With the harmonic filter option, Agility™ meets the IEEE Standard 519 requirement of less than 5% TDD.



Application and Job Site Considerations

Low Condenser Water Temperatures

Agility™ chillers start and operate over a wide range of load conditions. Reducing the condenser water temperature is an effective way to lower the chiller power input; however, the effect of lowering the condenser water temperature may cause an increase in system power consumption. Although Agility™ chillers can start and operate without control of the condenser water temperature, integrated control of the chillers, pumps, and towers is easily accomplished with the chiller controller and/or Tracer® building controls.

Most chillers are designed for entering tower temperatures around 85°F (29.5°C), but Agility™ chillers can operate at reduced lift and it does not have a minimum pressure differential between the condenser and evaporator. This allows for entering condenser water temperatures at or below 40°F (4.4°C) dependent on a variety of factors such as load, leaving evaporator temperature, and component combinations.

Water Treatment

The use of untreated or improperly treated water in a chiller may result in scaling, erosion, corrosion, algae, or slime. It is recommended that the services of a qualified water treatment specialist be used to determine what treatment, if any, is advisable. Trane assumes no responsibility for the results of untreated, or improperly treated water.

Water Flow Strategies

Today's technology challenges AHRI's traditional design of 3 gpm/ton (0.054 L/s·kW) through the condenser. Reduced condenser flows are a simple and effective way to reduce both first and operating costs for the entire chiller plant. This design strategy will require more effort from the chiller. But pump and tower savings will typically offset any penalty. This is especially true when the plant is partially loaded or condenser relief is available.

In new systems, the benefits can include dramatic savings associated with:

- Size and cost of the water pumps and cooling tower
- Pump and cooling tower fan energy (30 to 35 percent reduction)
- Size and cost for condenser lines and valves

Replacement chiller plants can reap even greater benefits from low flow condensers. Because the water lines and tower are already in place, reduced flows offer tremendous energy savings. Theoretically, a 2 gpm/ton (0.036 L/s·kW) design applied to a 3 gpm/ton (0.054 L/s·kW) system would offer a 70 percent reduction in pump energy. At the same time, the original tower would require a nozzle change but would then be able to produce about two degrees colder condenser water than before. These two benefits would typically offset any extra effort required by the chiller.

Contact your local Trane account manager for information regarding optimum condenser water temperatures and flow rates for a specific application.

Shipment and Assembly

Each Agility™ chiller ships as a factory assembled, factory tested package, fully charged, ready to rig into place on factory-supplied isolation pads.

Each Agility™ chiller is shrink-wrapped to help ensure that it is delivered to the customer in the same condition it left the factory. The packaging process used is industry-leading; each unit is covered with a six-sided 10 mil, military-grade recyclable film.



Controls

Tracer AdaptiView Controller

Agility™ chillers leverage a Tracer® AdaptiView™ controller, which uses Feed Forward Adaptive Control™ strategies to anticipate and compensate for changes in the chiller's operating conditions. Key features and benefits of the Tracer® AdaptiView™ chiller control are highlighted here.

Control Panel and Operator Interface

The Tracer® AdaptiView™ control panel is a 12 inch (30.5 centimeter) touchscreen display that provides an intuitive navigation system. This control panel allows the user to select from 27 different languages to ensure that the operator can easily see and understand how the chiller is operating.

Figure 1. Tracer AdaptiView control



- Data graphs
- Mode overrides
- Status (all subsystems) with animated graphics
- Auto/Stop commands
- 60 diagnostics
- ASHRAE chiller log
- Setpoint adjustment (daily user points)

Feed Forward Adaptive Control

Feed Forward Adaptive Control™ is an open loop, predictive control strategy that uses the evaporator entering water temperature as an indicator of load change, allowing the controller to respond faster and to maintain stable leaving water temperatures. Feed Forward Adaptive Control™ algorithms are patented control strategies that respond to both normal and extreme operating conditions to maintain effective chiller plant operation.

Variable-Primary Flow (VPF)

Chilled-water systems that vary the water flow through the chiller evaporator have caught the attention of engineers, contractors, building owners, and operators. Varying the water flow reduces the energy consumed by pumps, while having limited effect on the chiller energy consumption. This strategy can be a significant source of energy savings, depending on the application. As standard, the Agility™ chiller can handle up to 30 percent change in flow per minute and stay online. Add the “[Optional Enhanced Flow Management Package](#),” p. 11 for even greater capacity control and the ability to display the evaporator and condenser flow rates on the control panel.

Chilled-Water Reset

Chilled-water reset reduces chiller energy consumption during periods of the year when heating loads are high and cooling loads are reduced. It is based on return chilled-water temperature. Resetting the chilled-water temperature reduces the amount of work that the compressor must do by increasing the evaporator refrigerant pressure. This increased evaporator pressure reduces the pressure differential the compressor must generate while in the heat recovery mode. Chilled-water reset is also used in combination with the hot-water control. By resetting the chilled-water temperature upward, the compressor can generate a higher condenser pressure, resulting in higher leaving hot-water temperatures.

Optional Enhanced Flow Management Package

In multiple chiller plants that utilize a variable flow strategy, rapid changes in flow (60 seconds or less) can cause nuisance trips that knock the plant offline. These flow changes can be triggered when chillers stage on and off or bypass controls work to maintain balance. Regardless of the cause, this disruption could result in occupant complaints or worst-case, harm to critical systems serviced by the plant.

With Enhanced Flow Management included, the Tracer® Adaptiview chiller controller reliability accommodates variable evaporator water flow and virtually eliminates its effect on the chilled water temperature. Using a patented, variable water-flow compensation algorithm to maintain stable, precise capacity control, variable-flow compensation allows the chiller to respond quickly to changes in chilled water flow rate by automatically adjusting the control gain to account for these large changes in water-flow rate.

[Figure 2, p. 12](#) shows water temperature control without flow compensation; whereas [Figure 3, p. 12](#) shows water temperature control with flow compensation enabled. The chilled-water temperature remains stable, even when the water flow rate drops 50 percent in 30 seconds.

Another benefit is disturbance rejection. [Figure 4, p. 13](#) shows the test results from step changes in water flow with increasing magnitudes. The leaving chilled-water temperature remains largely unaffected. Even the most severe change — dropping water flow 66 percent in 30 seconds — caused only a small, 1.5°F (0.83°C) variation in chilled-water temperature. While it is unlikely that a chiller application would make water flow changes of this magnitude, the results demonstrate that the chiller is more than capable of supporting variable water flow applications.

The following data will be shown on the Tracer® Adaptiview control panel, the Tracer® TU display, and the Tracer® controls:

- Evaporator capacity (tons, kW)
- Evaporator and condenser flow rates (gpm, L/s)
- Evaporator and condenser differential water pressures (psid, kPaD)
- Evaporator and condenser differential water pressures (psid, kPaD)

It will automatically adjust capacity control to:

- Minimize variable-flow disturbance
- Maintain control stability at low flow

Figure 2. Capacity control without Enhanced Flow Management Package

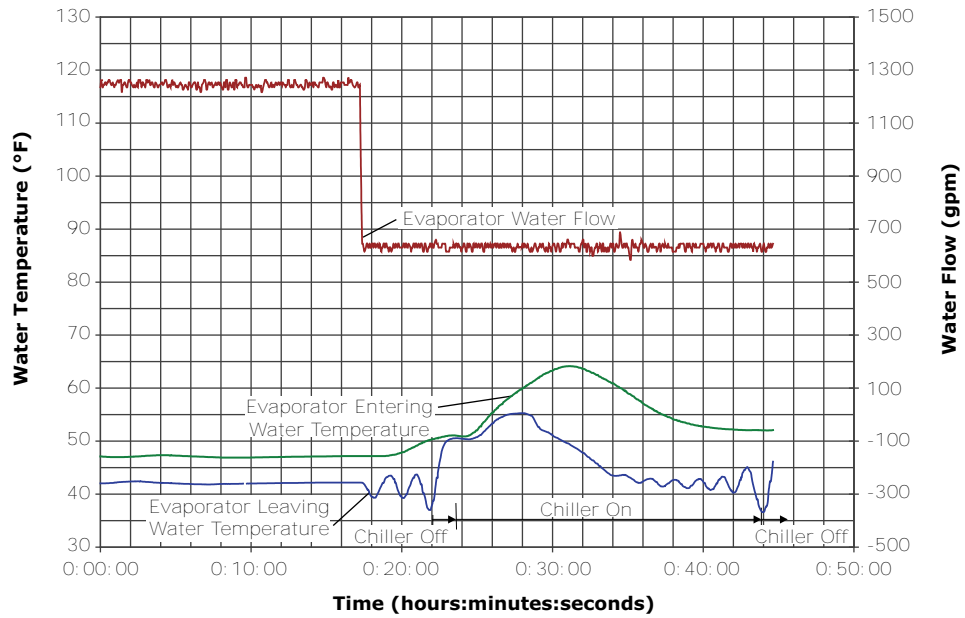

Figure 3. Capacity control with Enhanced Flow Management Package

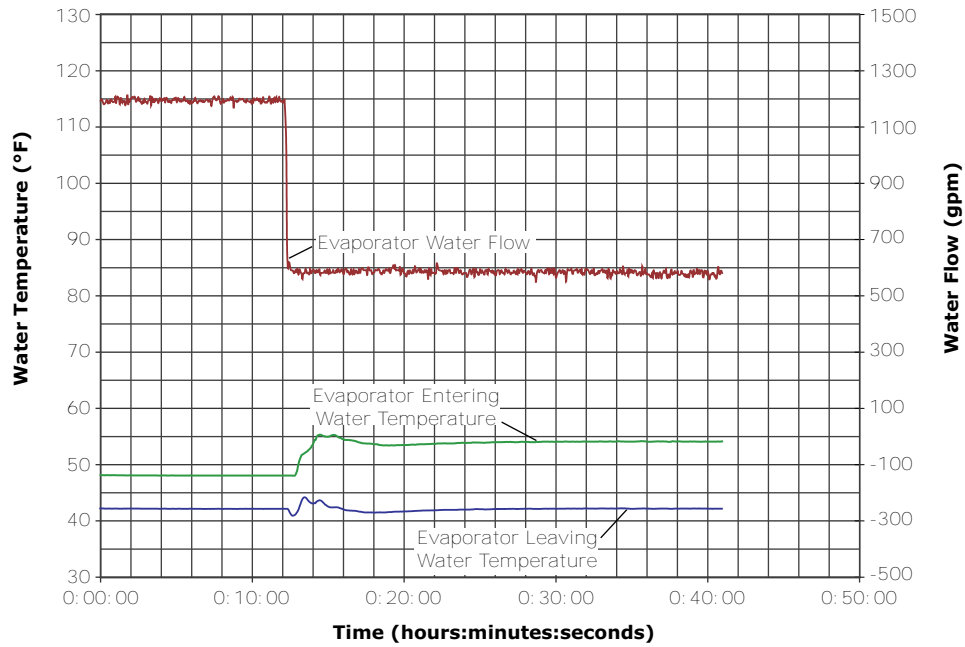
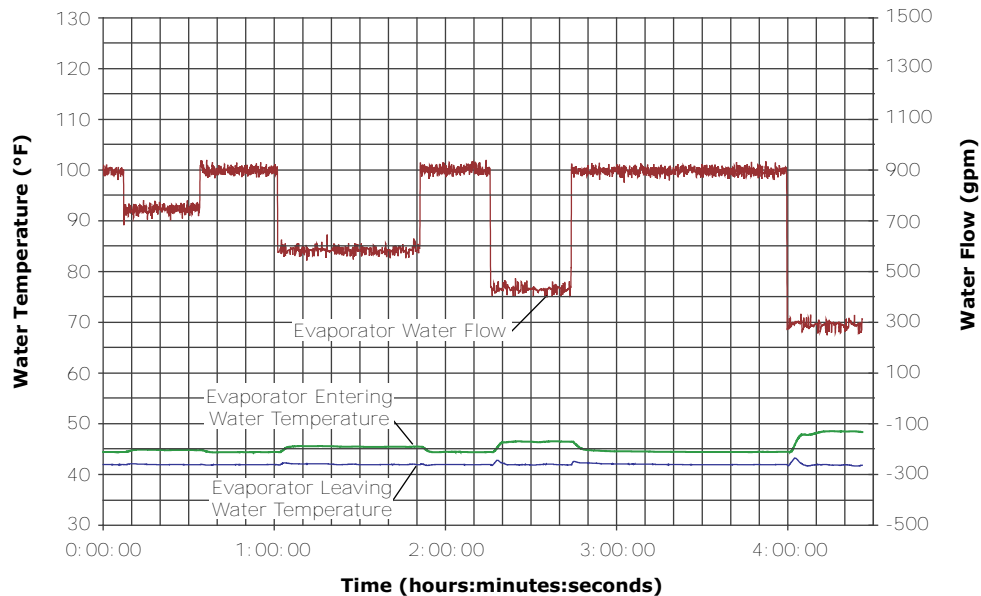

Figure 4. Capacity control with flow changes and Enhanced Flow Management Package



Communications Interfaces

LonTalk Communications Interface (LCI-C)

The optional LonTalk® Communications Interface for Chillers (LCI-C) is available factory or field installed. It is an integrated communication board that enables the chiller controller to communicate over a LonTalk® network. The LCI-C is capable of controlling and monitoring chiller setpoints, operating modes, alarms, and status. The Trane LCI-C provides additional points beyond the standard LonMark® defined chiller profile to extend interoperability and support a broader range of system applications. These added points are referred to as open extensions. The LCI-C is certified to the LonMark® Chiller Controller Functional Profile 8040 version 1.0, and follows LonTalk® FTT-10A free topology communications.

Native BACnet Communications

Tracer® AdaptiView™ control can be configured for BACnet® communications at the factory or in the field. This enables the chiller controller to communicate on a BACnet® MS/TP network. Chiller setpoints, operating modes, alarms, and status can be monitored and controlled through BACnet®.

Tracer® AdaptiView™ controls conform to the BACnet® B-ASC profile as defined by ANSI/ASHRAE Standard 135-2004.

Modbus Communications

Tracer® AdaptiView™ controls can be configured for Modbus® communications at the factory or in the field. This enables the chiller controller to communicate as a slave device on a Modbus® network. Chiller setpoints, operating modes, alarms, and status can be monitored and controlled by a Modbus® master device.

Tracer TU Interface

The Tracer® chiller controller adds a level of sophistication better served by a PC application to improve service technician effectiveness and minimize chiller downtime. The Tracer® AdaptiView™ control's operator interface is intended to serve only typical daily tasks. The portable PC-based service-tool software, Tracer® TU, supports service and maintenance tasks.

Tracer® TU serves as a common interface to all UC800 and BCI-C (BACnet®) based Trane® chillers, and will customize itself based on the properties of the chiller with which it is communicating. Thus, the service technician learns only one service interface.



The panel bus is easy to troubleshoot using LED sensor verification. Only the defective device is replaced. Tracer® TU can communicate with individual devices or groups of devices.

All chiller status, machine configuration settings, customizable limits, and up to 100 active or historic diagnostics are displayed through the service-tool software interface.

LEDs and their respective Tracer® TU indicators visually confirm the availability of each connected sensor, relay, and actuator.

Tracer® TU is designed to run on a customer's laptop, connected to the Tracer® AdaptiView™ control panel with a USB cable.

Contact your local Trane account manager for more information.

Building Automation and Chiller Plant Control

System and Chiller Plant Controls

Tracer® SC allows you to streamline facility management without reinventing the entire system. Adding Tracer® SC to your system provides a flexible, cost effective solution for building automation and climate control that can extend to lighting and energy consumption. Accessible from a personal computer, tablet or smart phone, Tracer® SC eliminates the need for a dedicated computer so you can manage system performance whenever and wherever it is convenient. Tracer® SC is a simplified, web-based management tool that reduces scheduling, reporting and system application chores to simple "point and click" tasks. Tracer® SC strikes the perfect balance between tenant comfort and energy efficiency, resulting in operating cost savings and a better bottom line.

Note: Tracer SC can be factory installed as an option in the Agility Control Panel.

Area Application

The Area application coordinates groups of equipment based on tenant or occupant organization within a building, allowing for standard calculations and functions. The Area application can be configured to use multiple algorithms, along with area temperatures and humidity inputs, to make an economizing decision. Users are presented with a simplified, logical user interface with logical areas rather than directly interfacing with equipment. The Area application also supports:

- Optimal start/stop
- Humidity pulldown
- Night purge
- Unoccupied heating/cooling setpoints
- Unoccupied humidify/dehumidify
- Timed override functions

For more information, refer to BAS-APG007*-EN (*Applications Guide: Air Systems [including EarthWise Systems] for the Tracer SC System Controller*).

Chiller Plant Control (CPC)

The Chiller Plant Control (CPC) application permits users to configure a chiller plant for optimal efficiency and reliability, while providing a means for monitoring and controlling the daily operation. Depending upon the chiller plant configuration and design, the CPC application can do the following:

- Provide overall chiller plant status information and alarms to local and remote Tracer® SC users
- Enable or disable chiller plants
- Start, stop, and monitor the status of system chilled water pumps
- Calculate individual chilled water setpoints for chillers in series chiller plants
- Request when chillers are added or subtracted according to building load requirements and user-specified add and subtract logic
- Rotate chillers according to user-defined intervals
- Remove chillers from the rotation in the event

For more information, refer to BAS-APG012*-EN (*Applications Guide: Tracer SC System Controller Chiller Plant Control Application*).

Chiller-Tower Optimization

The Tracer® chiller-tower optimization extends Adaptive Control™ to the rest of the chiller plant. Chiller-tower optimization is a unique control algorithm for managing the chiller and cooling tower subsystem. It considers the chiller load and real-time ambient conditions, then optimizes the tower setpoint temperature to maximize the efficiency of the entire subsystem. This real-time optimization may vary tower temperatures between 50°F–90°F (10°C–32.2°C) depending upon current outdoor conditions, chiller loading, and ancillary efficiencies.

Tracer Building Controls

The Tracer® AdaptiView™ chiller controller is designed to communicate with a wide range of building automation systems. To leverage all of your Agility™ chiller capabilities, integrate your chiller into a Tracer® SC system controller or a comprehensive Tracer® ES building management system.

The Tracer® SC system controller can manage multiple systems within a building. It provides a flexible solution for managing your building's HVAC system, with an intuitive, web-based user interface and industry-leading 3D graphics and pre-programmed features such as:

- **Chiller plant management**—Allows you to manage multiple chillers of any size and coordinate with other equipment as part of your chiller plant operation for even greater energy efficiency and reduced operating costs.
- **EarthWise™ Systems**—Apply integrated pre-packaged design concepts that are optimized for energy and environmental performance; sustainable systems that deliver measurable, repeatable and superior performance with lower operating costs.

The Tracer® ES building management software provides a web-based, scalable, integration platform for managing all of your facilities as a single enterprise. It allows you to view status and manage alarms and schedules from one system—from anywhere, and its reports enable enterprise-wide decision making for optimized performance. It also offers easy integration with other systems via BACnet® IP.

Standard Protections

The Tracer® AdaptiView™ controller uses proportional-integral-derivative (PID) control for all limits—there is no dead band. This removes oscillation above and below setpoints and extends the capabilities of the chiller. Some of the standard protection features of the chiller controller are described in this section.

Contactor Interrupt Failure

The chiller will protect itself from a starter failure that prevents disconnecting the compressor motor from the incoming line power.

High Condenser-Pressure Protection

The chiller controller's condenser limit keeps the condenser pressure under a specified maximum pressure. The chiller will run up to 100 percent of this setpoint before the Adaptive Control™ mode reduces capacity.

Loss of Water-Flow Protection

Tracer® AdaptiView™ control has an input that will accept a contact closure from a proof-of-flow device such as a flow switch or pressure switch. Customer wiring diagrams also suggest that the flow switch be wired in series with the cooling-water and condenser-water pump starter auxiliary contacts. When this input does not prove flow within a fixed time during the transition from Stop to Auto modes of the chiller, or if the flow is lost while the chiller is in the Auto mode of operation, the chiller will be inhibited from running by a diagnostic.



Evaporator Limit Protection

Evaporator Limit is a control algorithm that prevents the chiller from tripping on its low refrigerant-temperature cutout. The machine may run down to the limit but not trip. Under these conditions the intended chilled-water setpoint may not be met, but the chiller will do as much as it can. The chiller will deliver as much cold water as possible even under adverse conditions.

Low Evaporator-Water Temperature

Low evaporator-water temperature protection, also known as Freeze Stat protection, avoids water freezing in the evaporator by immediately shutting down the chiller and attempting to operate the chilled-water pump. This protection is somewhat redundant with the Evaporator Limit protection, and prevents freezing in the event of extreme errors in the evaporator-refrigerant temperature sensor.

The cutout setting should be based on the percentage of antifreeze used in the customer's water loop. The chiller's operation and maintenance documentation provides the necessary information for percent antifreeze and suggests leaving-water temperature-cutout settings for a given chilled-water temperature setpoint.

High Vacuum-Lockout Protection

The controller inhibits a compressor start with a latching diagnostic whenever the evaporator pressure is less than or equal to 12.8 psia (88.3 kPaA). This protects the motor by locking out chiller operation while the unit is in a high vacuum—preventing startup without a refrigerant change during commissioning.

Phase-Unbalance Protection

The Variable Frequency Drive (VFD) monitors drive input phase unbalance by monitoring the amount of ripple voltage on the DC bus. Voltage imbalances greater than 3 percent will result in a manual reset shut down diagnostic.

Phase-Loss Protection

The Variable Adaptive Frequency Drive (VFD) monitors for drive output current phase loss. A loss of any of the output currents will result in a manual reset shut down diagnostic.

Phase Reversal/Rotation Protection

The magnetic bearing controller (MBC) faults on reverse rotation.

Momentary Power Loss and Distribution Fault Protection

The Variable Frequency Drive (VFD) will call out an auto reset shut down diagnostic for low input voltages. After regaining adequate voltage, the diagnostic will clear and the controller may initiate a start. At all times, the VFD will safely restart the motor.

Current-Overload Protection

The Variable Frequency Drive (VFD) will monitor the current drawn by each line of the motor and shut the chiller off when the highest of the three line currents exceeds the trip curve. A manual reset diagnostic describing the failure will be displayed. The current overload protection does not prohibit the chiller from reaching its full-load amperage. The chiller protects itself from damage due to current overload during starting and running modes, but is allowed to reach full-load amps.

High Motor-Winding Temperature Protection

This function monitors the motor temperature and terminates chiller operation when the temperature is excessive. The controller monitors each of the three winding-temperature sensors any time the controller is powered up, and displays each temperature at the service menu. The controller will generate a latching diagnostic if the winding temperature exceeds 265°F (129.4°C) for 0.5–2 seconds.

Surge Detection Protection

Surge detection is based on current fluctuations in one of three phases. The default detection criterion is two occurrences of root-mean square (RMS) current change of 20 percent within 0.8 seconds in 60 seconds \pm 10 percent.

Overtoltage and Undervoltage Protection

The Variable Frequency Drive (VFD) monitors drive input overvoltage by monitoring the voltage on the DC bus. When the voltage falls out of tolerance, an auto reset shutdown diagnostics will occur. When the drive input voltage falls back into tolerance, the diagnostics will clear and the controller will initiate a start.

Kilowatt Measurement

The Variable Frequency™ Drive (VFD) provides the drive input kilowatt (kW) measurement to the Tracer® AdaptiView™ display and through the controller's other communication interfaces (e.g., BACnet®, Modbus®, or LonTalk™).

Short-Cycling Protection

The chiller controls look at motor winding temperature, Variable Frequency™ Drive (VFD) heat sink temperature, motor bearing controller temperature, and compressor bearing temperature to ensure they are cool enough to allow a compressor to start.

Enhanced Condenser-Limit Control

Includes factory-installed condenser-pressure transducer and all necessary interconnecting piping and wiring. Enhanced condenser-limit control provides high-pressure cutout avoidance by energizing a relay to initiate head relief.

Compressor-Discharge Refrigerant-Temperature Protection

Includes a factory-installed sensor and safety cutout on high compressor discharge temperature. Allows the chiller controller to monitor compressor discharge temperature, which is displayed at Tracer® AdaptiView™ control and operator interface, Tracer® TU, and Tracer® building controls.



Chiller Selection

Performance

Trane Official Product Selection System (TOPSS™) software provides performance data for each chiller selection at the full-load design point and part-load operating points as required.

Changing the water flow rates may significantly alter the performance of a particular chiller. To obtain the maximum benefit from the wide range of selections available, designers are encouraged to develop performance specifications and use the computer selection program to optimize their selections. This will allow the selection of the particular compressor-evaporator-condenser combination that most closely meets the job requirements. All selections are made using the TOPSS™ selection program.

The TOPSS™ selection program is certified by AHRI in accordance with AHRI Standards 550/590 (I-P) and 551/591 (SI). To ensure that the specific chiller built for your project will meet the required performance, and to ensure a more trouble-free startup, it is recommended that the chiller be performance tested on an AHRI-approved factory test loop.

The TOPSS™ selection program has the flexibility to select chillers for excessive field fouling allowances.

Contact your local Trane account manager for more information or visit www.trane.com/myTest.

Fouling Factors

All heat exchanger tubes are subject to a certain amount of fouling during operation due to contaminants in the water and based on water treatment at the facility. Fouling impedes heat transfer and makes the chiller work harder.

AHRI Standards 550/590 (I-P) and 551/591 (SI) include a definition of the standard fouling factors to be used in water-cooled chiller ratings. The standard fouling adjustment is a 0.0001 increment from 0.0000 ("clean") on the evaporator and 0.00025 increment from 0.0000 ("clean") on the condenser.

Chiller specifications should be developed using the most current standard fouling factors.

Unit Performance with Fluid Media Other Than Water

Agility™ chillers can be selected with a wide variety of media other than water. Agility™ chillers can only be selected with these media in the condenser; only water may be selected in the evaporator. Chillers using media other than water are excluded from the AHRI Certification Program, but are rated in accordance with AHRI Standard 550/590. Trane® factory performance tests are only performed with water as the cooling and heat rejection media. For fluid media other than water, contact your local Trane account manager for chiller selections and information regarding factory performance testing.

Flow Rate Limits

Flow rate limits for evaporators and condensers are included in the selection program. Please refer to the AHRI Certified TOPSS selection program for the selected configuration flow rate limits.

Full-Load and Part-Load Performance

The Agility™ chiller possesses excellent performance characteristics over its full range of operation due to multi-stage, direct drive compressor that enables stable and efficient operation over a wide range of conditions.

In order to evaluate total energy costs over a period of time, an in-depth examination of project-specific conditions and energy rate structures should be performed. Trane Air Conditioning Economics, or TRACE™, is a software program that helps HVAC professionals perform this type of analysis and optimize the design of a building's heating, ventilating and air conditioning

system based on energy utilization and life-cycle cost. Visit www.traneCDS.com for more information.

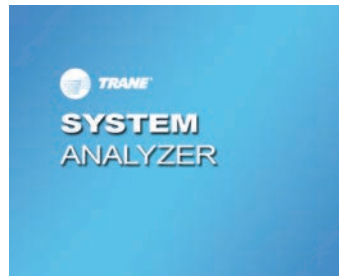
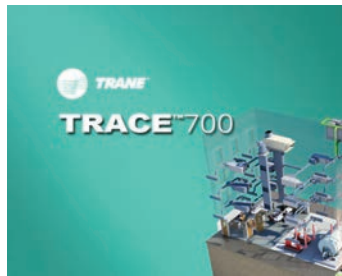

Local utilities may offer substantial monetary rebates for centrifugal chillers with specific efficiency ratings. Contact your local utility or your local Trane account manager for further information.

myPLV Chiller Performance Evaluation Tool

The myPLV™ tool provides a simpler tool than TRACE provides for quick and reliable chiller economic comparisons considering both full and part load ratings.

The manufacturer-agnostic tool leverages industry-standard building model data, calculating four performance points (94, 75, 50 and 25 percent) based on the specific building type, location and plant design, providing accurate weighting points and condenser temperatures. The myPLV™ tool also calculates the ton-hours at each of those points necessary to accurately estimate annualized energy use.

Utilizing the myPLV™ tool from the beginning assures that the selected chiller is appropriate for the particular application. Then, myTest™ certification confirms the chiller performs as expected.

To learn more or to download a free copy of the myPLV™ tool, please visit www.trane.com/myPLV.

Figure 5. myPLV—compare chiller performance

myPLV™ calculator

Unit of Measure: SI

Region: West & Central Asia

Country: Turkey (TUR)

State/territory:

City/location: Istanbul / Ataturk (3A)

Building Type and Airside Economizer: Office with Econ

Chiller Condenser Type: Water Cooled Chiller

Building Peak Load: 6000 kW

Number of Chillers in Plant: 2

Size of Each Chiller: 3000 kW

Plant Capacity (Calculated Point): 6000 kW

ASHRAE 90.1 app G oversize factor (Calculated Point): 0%

Enter Custom Load

Assumes equal size chillers in parallel

Calculate myPLV™ Conditions

myPLV™ Test and Submittal Points

Enter chiller performance values for four submittal points.

% FL	kW	KW-hrs	weighting	ECWT	Chiller kW/kW
25%	750	689,639	8.2%	15.5° C	0.155
50%	1,500	2,770,231	32.9%	23.3° C	0.136
75%	2,250	3,823,317	45.5%	26.1° C	0.135
94%	2,820	1,128,822	13.4%	27.2° C	0.138
design	3,000		0%	29.4° C	0.151
Total kW-hrs		8,412,009			myPLV™
					Annualized kWh
					1,155,571



Unit Specifications—Imperial (I-P) and International System (SI) Units

Dimensions

**Base Unit
(Assembled)**

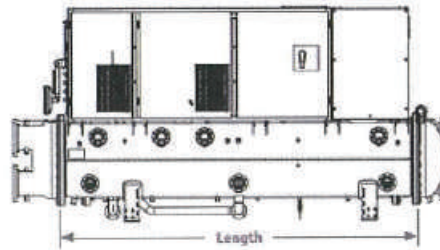
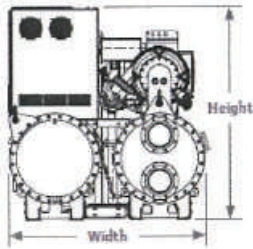

Unit Configuration	
Compressor	Shell Config (EVAP/COND)
200	020/020
300	020/020
300	040/040
400	040/040

Base Unit Dimensions (Assembled)					
Length		Width		Height	
in	mm	in	mm	in	mm
129.9	3300	67.4	1713	72.2	1833
129.9	3300	67.4	1713	72.2	1833
129.9	3300	70.7	1795	78.0	1981
129.9	3300	70.7	1795	78.0	1981

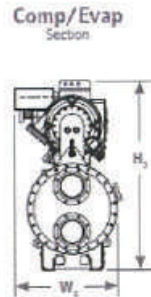
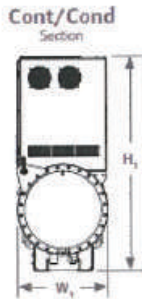

Cont/Cond Section			
Width (W ₁)		Height (H ₁)	
in	mm	in	mm
33.8	858	72.2	1833
33.8	858	72.2	1833
33.8	859	78.0	1981
33.8	859	78.0	1981

Comp/Evap Section			
Width (W ₂)		Height (H ₂)	
in	mm	in	mm
34.9	896	63.4	1610
35.2	893	68.4	1738
35.2	893	68.4	1738
35.2	893	68.4	1738

Unit Specifications—Imperial (I-P) and International System (SI) Units

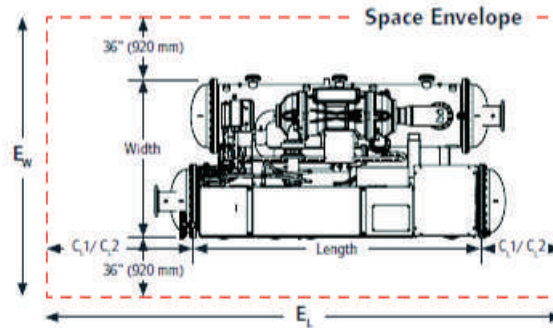

Unit Configuration	
Compressor	Shell Config (EVAP/COND)
200	020/020
300	020/020
300	040/040
400	040/040

Space Envelope					
Length (E_L)		Width (E_W)		Height	
in	mm	in	mm	in	mm
300.8	7641	139.4	3553	108.2	2753
300.8	7641	139.4	3553	108.2	2753
300.8	7641	142.7	3635	114.0	2901
300.8	7641	142.7	3635	114.0	2901

Unit Clearance					
Tube Pull (C_{L1} / C_{L2})		Unit length (no water boxes)		Height	
in	mm	in	mm	in	mm
129.9	3300	41.0	1041	36.0	920
129.9	3300	41.0	1041	36.0	920
129.9	3300	41.0	1041	36.0	920
129.9	3300	41.0	1041	36.0	920

Notes: Dimensions do not include waterboxes, fringes or other unit-mounted options that may affect unit size.

1. C_{L1} can be at either end of the machine and is required for tube pull clearance.
2. C_{L2} is always at the opposite end of the machine from C 1 and is required for service clearance. Contact your Trane representative for more information.

Weights (lb)

Important: The weight information provided here should be used for general information only. For specific weights for your chiller, refer to your submittal package.



Unit Specifications—Imperial (I-P) and International System (SI) Units

Table 1. Agility chiller weights (lb)

Shell		Shipping Weight		Operating Weight
		With Refrigerant	Without Refrigerant	
020	Minimum	10100	9575	14087
	Maximum	12302	11777	16775
040	Minimum	12706	11906	14134
	Maximum	15058	14258	16830

Notes:

1. All weights ± 5 percent.
2. Shipping weights include standard 150 psig waterboxes.
3. Operating weights include refrigerant, glycol, and water charges.
4. Optional waterbox hinges each weigh 44 lb (19.94 kg).



Unit Specifications—International System (SI) Units

Weights (kg)

Important: The weight information provided here should be used for general information only. For specific weights for your chiller, refer to your submittal package.

Table 2. Agility chiller weights (kg)

Shell		Shipping Weight		Operating Weight
		With Refrigerant	Without Refrigerant	
020	Minimum	4591	4352	4980
	Maximum	5592	5353	5836
040	Minimum	5775	5412	6425
	Maximum	6845	6481	7650

Notes:

1. All weights ± 5 percent.
2. Shipping weights include standard waterboxes.
3. Operating weights include refrigerant, glycol, and water charges.
4. Optional waterbox hinges: each waterbox hinge weights 44 lb (19.94 kg).



Mechanical Specifications

Compressor-Motor

Direct drive multiple-stage compressor, single-stage capacity control guide vanes. Dynamically balanced, shrouded aluminum alloy impellers. Refrigerant-cooled, hermetically sealed, two-pole, permanent magnet motor. Two magnetic bearings support the rotating assembly. Fully integrated magnetic bearing controller (MBC).

Evaporator-Condenser

Shells are carbon steel plate. Evaporator and condenser include relief devices per ASME Section VIII, Div. 1/ASHRAE 15 Safety Code. Carbon steel tube sheets are drilled, reamed and grooved to accommodate tubes. Tubes are individually replaceable externally finned seamless copper. Tubes are mechanically expanded into tube sheets. A multiple orifice control system maintains proper refrigerant flow. Condenser baffle prevents direct impingement of compressor discharge gas upon the tubes. Refrigerant side of the assembled unit is tested at both pressure (300.00 psi [2068.43 kPa] condenser/200.00 psi [1378.95 kPa] evaporator leak test) and vacuum. Water side is hydrostatically tested at one and one-half times design working pressure, but not less than 225.00 psi (1551.32 kPa).

Trane reserves the right to implement chiller technology enhancements that will reduce the chiller's refrigerant charge, with no impact on chiller performance. Changes may be reflected in the chiller's nameplate refrigerant charge and the quantity of refrigerant charge shipped in the unit or to the jobsite, depending upon the final date of equipment manufacture.

Waterboxes

Drains and vents—Waterboxes typically have 3/4-inch NPTI vents and drain connections provided. Evaporators and condensers have one vent and one drain. If grooved connections are offered, the design is based on Style 77.

Economizer

A thermal economizer with no moving parts provides power saving capability.

Tracer AdaptiView Control Panel

The Tracer® AdaptiView™ is a microprocessor-based chiller control system that provides complete stand alone system control and monitoring for the water-cooled Agility™. It is a factory-mounted package including a full complement of controls to safely and efficiently operate the Agility™ chiller, interface to the starter, and comprehensive motor protection. Inlet and outlet water (fluid) temperature sensors are located in the evaporator and condenser waterbox connections as standard.

The display is a touch sensitive 12-1/8-inch diagonal color liquid crystal display (LCD) that uses color graphics and animation to ensure ease of use. The touch-sensitive interface allows the operator to view the chiller graphically and receive a status indication via subsystem animations. The operator can navigate easily between the primary chiller subsystems including: compressor, evaporator, condenser, and motor. For each subsystem, you can view status and detailed operating parameters. In addition, alarms, reports, trending, and settings can all be accessed quickly from the main screen. The display is mounted on a flexible "arm" that allows extensive height and viewing angle variations.

The panel supports an extensive list of languages including the default English. The data can be set to be viewed in inch pounds (I-P) or metric units (SI). Class 1 control panel voltage (30–115 V) are clearly labeled on the field wiring diagram. Class 2 input voltage (30 V maximum) is also labeled on the field wiring diagram.

Operating Data

The Tracer® AdaptiView™ control panel displays operating data including:

- Operating hours
- Number of starts
- Chilled water setpoint
- Evaporator and condenser water flow status
- Evaporator entering and leaving water temperatures
- Evaporator saturated refrigerant temperatures
- Evaporator approach temperature
- Evaporator refrigerant pressure
- Condenser entering and leaving water temperatures
- Condenser saturated refrigerant temperatures
- Condenser approach temperature
- Condenser refrigerant pressure
- Variable Frequency Drive (VFD) average motor current % RLA
- Motor winding temperatures
- VFD output power

The Tracer® AdaptiView™ control panel also contains the following dedicated reports:

- Evaporator
- Condenser
- Compressor
- Motor
- ASHRAE

Each report is comprised of a detailed listing of operational data relative to that chiller subsystem.

Control Functions

The Tracer® AdaptiView™ control panel features control functions including:

- Leaving chilled water temperature
- Percent demand limit
- Chiller water reset (based on return water temperature)
- Front panel control type
- Setpoint source
- Differential to start
- Differential to stop

Status Data

The Tracer® AdaptiView™ control panel displays status data including:

- Waiting to start
- Running
- Run limit
- Run inhibit (adaptive)
- Auto
- Preparing shutdown
- Shutting down
- Stopped

Safeties

The Tracer® AdaptiView™ control panel features safeties including automatic safety shutdown for:

- Low chilled water temperature



Mechanical Specifications

- Low evaporator refrigerant temperature
- High condenser refrigerant pressure
- Evaporator and condenser flow status
- High motor temperature
- Variable Frequency Drive (VFD) function faults
- Critical temperature and pressure sensor faults
- VFD motor current overload

These devices are of a latching trip out type requiring manual reset. Non-latching safety trip outs for operating conditions external to the chiller automatically permits unit to resume normal operation when condition is resolved.



Appendix A: Chiller Operating Cycles

Compressor Motor

All Agility™ chiller motors are cooled by refrigerant vapor. Using vapor refrigerant results in uniform low temperatures throughout the motor, which prolongs motor life over open designs. Motor heat is rejected out to the cooling tower, which helps keep the equipment room at a desirable temperature.

Permanent Magnet—A specially designed, two-pole motor suitable for unit inputs of low voltage 60 or 50 Hz, three-phase current.

Expansion Valve (Variable Orifice) Flow Control

For proper refrigerant flow control at all load conditions, the Agility chiller design incorporates an electronically-controlled expansion valve. Valve position responds to changing operating conditions to ensure proper refrigerant management in the heat exchangers and optimal chiller performance at all load points.

Multiple Stages of Compression

The multi-stage design provides a stable operating envelope to meet dynamic system needs for reliable operation in all real-world conditions. It also enables the use of a flash economizer for better efficiency.

Inlet Guide Vanes

Part-load performance is further improved through the use of moveable inlet guide vanes. Inlet guide vanes improve performance by throttling refrigerant gas flow to exactly meet part-load requirements and by pre-rotating the refrigerant gas. Pre-rotation minimizes turbulence and increases efficiency.

Flash Economizer

Agility™ chillers leverage a multi-stage design with two impellers, making it possible to flash refrigerant gas at intermediate pressure between the condenser and evaporator, significantly increasing chiller efficiency.

- Two-stage Agility™ chillers utilize a single-stage economizer with sub-cooler, providing up to 4.5 percent better efficiency than designs with no economizer.

These improvements in efficiency are not possible in single-stage chillers where all compression is done by one impeller.

Appendix B: Chiller Pressure-Enthalpy (P-H) Diagrams

Figure 6. Agility chiller P-H diagram

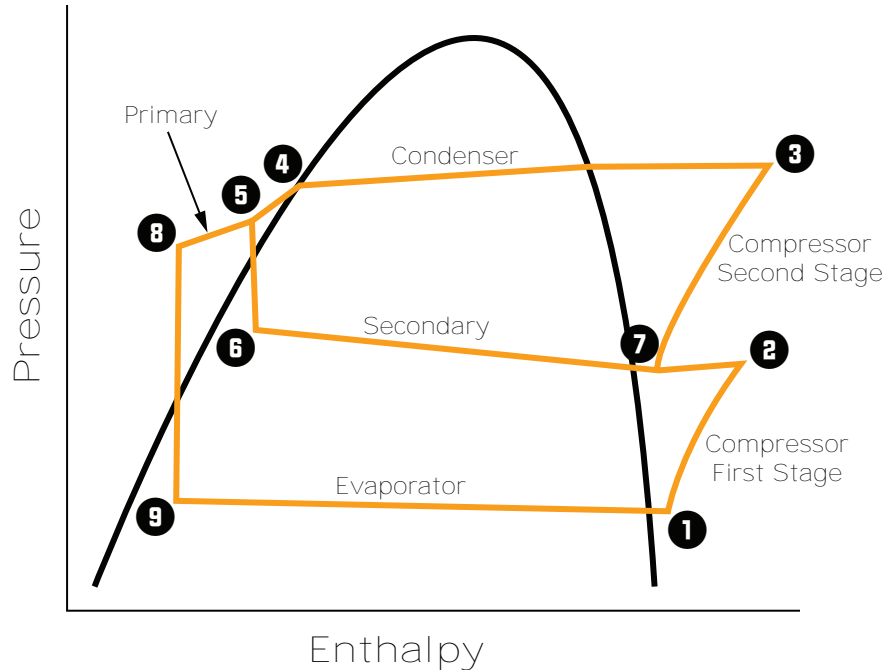

The pressure enthalpy (P-H) diagrams show refrigerant flow through the major chiller components. The diagrams confirm the superior cycle efficiency of the multi-stage Agility compressor with economizer.

Evaporator — A liquid gas refrigerant mixture enters the evaporator (point 9). Liquid refrigerant is vaporized (point 1) as it absorbs heat from the system cooling load. The vaporized refrigerant then flows into the compressor's first stage.

Compressor First Stage — Refrigerant gas is drawn from the evaporator into the compressor. The first stage impeller accelerates the gas, increasing its temperature and pressure into the first state of the compressor (point 2).

Compressor Second Stage — Refrigerant gas leaving the first stage of the compressor is mixed with cooler refrigerant gas from the secondary side of the brazed plate heat exchanger economizer (point 7). This mixing lowers the enthalpy of the mixture entering the second stage. The second stage impeller accelerates the gas, further increasing its temperature and pressure (point 3).

Condenser — Refrigerant gas enters the condenser where the system cooling load and heat of compression are rejected to the condenser water circuit. This heat rejection cools and condenses the refrigerant gas to a liquid (point 4). The liquid refrigerant flows through an internal subcooler, where additional energy in the refrigerant liquid passes into the condenser water circuit (point 5).

Economizer — The liquid refrigerant is split such that the primary flow is directed through one side of the brazed plate heat exchanger economizer, while a significantly smaller portion of the flow passes through an expansion valve, lowering refrigerant pressure and temperature before entering phase refrigerant (point 6). The heat transfer between the primary and secondary channels in the BPHE results in further subcooling of the primary liquid (point 8) as it rejects heat to, and consequently superheats, the secondary flow. The additional subcooling of the liquid prior to expansion through the main electronically controlled valve (point 9) effectively increases the overall capacity of the evaporator.



Appendix C: Standard Conversions

To Convert From:	To:	Multiply By:
Length		
Feet (ft)	meters (m)	0.30481
Inches (in.)	millimeters (mm)	25.4
Area		
Square feet (ft ²)	square meters (m ²)	0.093
Square inches (in. ²)	square millimeters (mm ²)	645.2
Volume		
Cubic feet (ft ³)	cubic meters (m ³)	0.0283
Cubic inches (in. ³)	cubic mm (mm ³)	16387
Gallons (gal)	liters (L)	3.785
Gallons (gal)	cubic meters (m ³)	0.003785
Flow		
Cubic feet/min (cfm)	cubic meters/second (m ³ /s)	0.000472
Cubic feet/min (cfm)	cubic meters/hr (m ³ /h)	1.69884
Gallons/minute (gpm)	cubic meters/hr (m ³ /h)	0.2271
Gallons/minute (gpm)	liters/second (L/s)	0.06308
Velocity		
Feet per minute (fpm)	meters per second (m/s)	0.00508
Feet per second (fps)	meters per second (m/s)	0.3048
Energy, Power, and Capacity		
British thermal units per hour (Btu/h)	kilowatt (kW)	0.000293
British thermal units per hour (Btu)	kilocalorie (kcal)	0.252
Tons (refrig. effect)	kilowatt (refrig. effect)	3.516
Tons (refrig. effect)	kilocalories per hour (kcal/hr)	3024
Horsepower	kilowatt (kW)	0.7457
Pressure		
Feet of water (ft H ₂ O)	pascals (Pa)	2990
Inches of water (in. H ₂ O)	pascals (Pa)	249
Pounds per square inch (psi)	pascals (Pa)	6895
Pounds per square inch (psi)	bar or kg/cm ²	6.895 x 10 ⁻²
Weight		
Ounces	kilograms (kg)	0.02835
Pounds (lb)	kilograms (kg)	0.4536
Fouling factors for heat exchangers		
0.00085 ft ² ·°F·h/Btu	= 0.132 m ² ·°K/kW	
0.00025 ft ² ·°F·h/Btu	= 0.044 m ² ·°K/kW	

Temperature Conversions

Scale		Temperature			Temperature Interval	
		°C	°F		°C	°F
Celsius	x°C =	x	1.8x + 32	1°C =	1	9/5 = 1.8
Fahrenheit	x°F =	(x-32) / 1.8	x	1°F =	5/9	1



Notes



The AHRI Certified mark indicates Trane U.S. Inc. participation in the AHRI Certification program. For verification of individual certified products, go to ahridirectory.org.

Trane - by Trane Technologies (NYSE: TT), a global innovator - creates comfortable, energy efficient indoor environments for commercial and residential applications. For more information, please visit trane.com or tranetechnologies.com.

Trane has a policy of continuous product and product data improvements and reserves the right to change design and specifications without notice. We are committed to using environmentally conscious print practices.