



Indoor liquid chiller with integrated hydraulic module

**Water-cooled: CGWN 205 – 206 – 207 – 208 –
209 – 210 – 211 – 212 – 213 – 214 – 215**

**Condenserless: CCUN 205 – 206 – 207 – 208 –
209 – 210 – 211 – 212 – 213 – 214 – 215**

***AquaStream*²**®



CG-PRC014G-GB

Table of Contents

Introduction	4
Features and benefits.....	5
Options.....	8
Applications consideration	9
Control	13
Selection Procedures	17
Performances	18
General data.....	19
Hydraulic data	24
Sound performances	28
Typical unit schematics.....	29



Introduction

The Indoor AquaStream²® chillers range equipped with Scroll compressors combines the latest technologies available to offer an optimum answer for today's air-conditioning and process cooling applications:

- Scroll compressor technology, with high performance, limited maintenance and longer life time design
- Latest generation of Trane controls, with user friendly graphical interface and integral auto-adaptive to guarantee maximum dependability
- High efficiency heat exchangers, allowing significant savings on operating cost
- Integrated hydraulic packages, to shorten installation and commissioning time.

Features and benefits

Industry leading performance and flexibility for design engineers

The next generation: designed for You

The third generation of the successful indoor Scroll compressor product range has several benefits over the previous design. Your suggestions led to the improvements we've incorporated, including:

- Higher full-load energy efficiency for lower operating and life-cycle costs
- CH530 controls, with touch-screen display and LonTalk®, Modbus, and BACnet capability
- Less sensitivity to condenser-water temperatures, alleviating concerns based on start-up temperatures
- Lighter weight for easier and less expensive handling and installation.

Applications: Operation and control advantages for most application

The Scroll compressor technology, with fewer moving parts, less rotating mass and less internal friction, associated with CH530 and Adaptive Controls™, allow the Indoor AquaStream²® range to be used in a wide variety of applications including:

- Comfort cooling: designed for reliability, energy efficiency, and system-design optimisation, whether the heat is rejected via an open cooling tower or a closed loop device (dry-cooler)
- Industrial process cooling: reliable operation with tight control of temperatures
- Ice/thermal storage
- Heat recovery
- Low-temperature process cooling.

System design and control: Greater application flexibility for increased savings

First-cost and operating cost minimising system-design concepts are catching on as their validity is proven through applications. These designs can provide lower equipment costs and lower operating costs than those possible with the traditional design methods and past chiller technologies. The concepts of the Indoor AquaStream²® range include:

- Heat exchangers with reduced water pressure drops and wider water flow/delta capability
- Thermal storage capability
- Variable primary (evaporator) chilled-water flow capability
- Series evaporator and/or condenser arrangements

The Indoor AquaStream²® range is designed for a wide range of applications and is especially suited for the dynamics of these system saving job designs. The dynamic benefits include:

- Efficient lift capability
 - Tight temperature control.
- CH530 controls mean that the CGWN/CCUN series chillers can maintain tight leaving-water temperature control in almost any application. These benefits fit especially well with the system design savings ideas listed above. As the compressor reaches the operating temperatures for the application, the controls, make sure you have total temperature control, even with chilled-water flow and/or load changes.

Sound: Lower sound levels through compressor and chiller design

Trane has a proven track record of continuously improving the sound levels of water chillers. With the Indoor AquaStream²® range, Trane has designed a fully hermetic cabinet design which minimises sound radiation in the neighbourhood of the unit. The space around the chiller can be utilised without requirement of additional sound insulation. The CCUN + outdoor condensing module can be an interesting alternative to an outdoor chiller: only the sound produced by the condenser fans can be perceived in the surrounding of the installation, the sound of compressor is attenuated by the building structure.



Features and benefits

Minimised job time for contractors through design and testing

Ease of installation

- **Footprint:** Central to the design of any project is the operating envelope of the chiller. With this in mind, Trane builds the chillers to make the most efficient use of the available installation space. The compact Indoor AquaStream²® range chiller is an excellent choice for any retrofit or replacement job. It is smaller than most chillers it might replace, and easier to fit into existing buildings. All units fit through a standard single door.
- **Weight:** Furthermore, the decreased weight reduces the requirements for lifting, rigging, and installation. Installation time and effort are reduced when dealing with a significantly smaller and lighter unit.
- **Commissioning:** Water cooled units (CGWN) come from the factory fully charged with refrigerant and oil, condenserless version (CCUN) with holding charge. Extensive factory testing helps ensure trouble-free start-up, resulting in lower installation costs and faster job completion.

Everything is in the box

Thanks to built-in components, installation is easy and you will make considerable savings using any available space in the technical room.

Only a main power supply and water connections are necessary, the main hydraulic components can be supplied in the "box":

The Indoor AquaStream²® integrated hydraulic can be supplied with the following components:

- Evaporator pump
- Evaporator strainer
- Expansion tank on cooling loop
- Valves
- Flow switch
- Pressure gauge
- Relief valve
- Condenser pump
- Condenser strainer.

The Integrated comfort system

The water-cooled AquaStream²® chiller, with the CH530, makes a powerful combination with the Trane Tracer Summit Building Management System to become part of a Trane Integrated Comfort system (ICS). An Integrated Comfort system is a building comfort system composed of Trane HVAC equipment, integral unit controllers, and building management. It is all designed and commissioned with Trane application expertise to provide comfort, efficiency, and reliability, as well as single-source warranty and service. Whether you are replacing a chiller or adding one to any centrally controlled plant, the Tracer CH530 chiller controller offers a wide range of interface options. Its ability to communicate with other systems using industry-standard control signals allows you to upgrade the control of your chiller plant regardless of your current control system.

Single-source responsibility

A wide range of products designed for complete compatibility are available with the Indoor AquaStream²® scroll chillers. Your entire building comfort system can be completed using components from Trane.

The added value of applications expertise

You get a quality chiller, properly selected and applied in a properly designed system. That means a comfort system that works, the first time!

Features and benefits

Reduced total life cycle operating cost for building owner.

Energy efficiency: Reduced annual operating expenses

The Indoor AquaStream²® chiller design has been optimized in order to achieve record efficiency levels. With the CH530 chiller control module, control over the chilled-water temperature is increased, simultaneously reducing annual operating costs. Indoor AquaStream²® chillers offer superior full-load performance and optimised part-load performance.

Reduced maintenance: Less time and money every year

The only recommended maintenance for an Indoor AquaStream²® chiller is an annual oil analysis. The hermetic design allows the compressor to be driven by a zero-maintenance motor. Strainers upstream the evaporator and condenser enhance the lifetime of heat exchangers. The Adaptive Control™ microprocessor also helps reduce unnecessary maintenance by monitoring, protecting, and taking corrective action so that the chiller stays on-line when you need it the most. Service calls for nuisance trip-outs are virtually eliminated.

Reliability

Trane has designed the Indoor AquaStream²® chiller range to be a leader in reliability for all applications:

- Simple design with 64 percent fewer parts than equal capacity reciprocating compressor.
- Advanced microelectronics protect both compressor and motor from typical electrical fault conditions.
- Scroll compressors have less than a third the torque variations of a reciprocating compressor.
- Years of laboratory testing have optimised compressor and chiller systems reliability.
- Water-cooled scroll chillers are factory tested.

Comfort cooling: designed for reliability, energy efficiency, and system design optimisation

Most comfort-cooling applications consider reliability and energy efficiency above all else in the design requirements. With proven reliability and high chiller efficiency, the Indoor AquaStream²® chillers are perfectly suited for these applications.

Industrial process cooling / Low temperature process: Reliable operation with tight control of temperatures

The Trane Indoor AquaStream²® chillers have the proven reliability required to keep the process running, eliminating concerns for chiller and resulting process downtime. The chiller matches system requirements and rapidly adjusts to match the changes seen by most processes.

Ice / thermal storage

The Trane Indoor AquaStream²® chillers can be used in partial or full thermal-storage applications because of their excellent compressor lift (operating temperature range) capability. High reliability and low maintenance means thermal storage applications are possible without a full-time operation/maintenance staff, and Trane Integrated Comfort System Controls can notify a computer or pager of any system issues.

Heat recovery

The Trane Indoor AquaStream²® chillers compressor lift capabilities also play well in heat recovery, or just high-temperature condenser applications. Building energy saving initiatives such as using condenser water for reheat (dehumidification), preheating boiler water, and providing domestic hot water are compatible with its temperature capabilities.

Easy serviceability

Trane Indoor AquaStream²® chillers are designed with service personnel in mind. All major components are replaceable without complete unit disassembly. Plus, CH530 provides diagnostic capability to aid service personnel in analysing problems. Therefore, in case a problem does occur, the chiller can be up and running in a shorter period of time.

Mechanical specifications

Refer to the Guide Specifications document.

Options

Evaporator hydraulic module

Versions available:

- No hydraulic control
- With pump contactors to control a remote pump (single or dual)
- With pump integrated hydraulic module, single or dual pump, low or high pressure head

Hydraulic module contents:

- Single or dual pump
- Expansion vessel
- Water pressure relief valve set to 4 bar
- Water strainer easily removable to allow quick cleaning
- Drainage valve
- Pressure ports for gauge connection
- Water pressure gauge
- Condensate collection and drainage (below pump)
- Pump winter freeze protection down to -18°C (the pump is activated under an ambient temperature setting)

Condenser hydraulic module

Versions available:

- No hydraulic control
- With pump contactors to control a remote pump (single or dual)
- With pump integrated hydraulic module:
 - sizes 205-211: 2 single pumps in parallel to adjust condenser waterflow as a function of unit capacity, low or high pressure head
 - sizes 212-215: Dual pump, low or high pressure head.
- With pump integrated hydraulic module and variable speed drives:
 - sizes 205-211: same pumps with separate variable speed drive
 - sizes 212-215: specific pump with integrated variable speed drive

Hydraulic module contents:

- Two pumps in parallel : sizes 205-211 (Variable speed drive available as option)
- One dual pump: sizes 212-215 (Variable speed drive available as option)
- Water strainer easily removable to allow quick cleaning
- Drainage valve
- Pressure ports for gauge connection
- Pump winter freeze protection down to -18°C (the pump is activated under an ambient temperature setting)

Hot water control

This option allows the control of the unit capacity based on the leaving condenser-water temperature to permit heat recovery.

Phase protection device

Inhibits operation of chiller in case of phase reversal.

Soft starter

To reduce starting current during compressor start.

Setpoint and temperature offset and display card

Allows to offset chilled water setpoint temperature based on either outside air, chilled water return or zone temperature and provides inlet/outlet condenser water temperature information.

High Efficiency Option (Only for sizes 205-211)

This option provides oversized heat exchangers to allow the unit to be more energy efficient.

Ice Making

The unit controls are factory set to handle ice making for thermal storage applications.

Communication Interface

Permits bi-directional communication to the Trane Integrated Comfort™ system and provides the LonMark® chiller profile input/outputs for use with a generic BAS (Building Automation System).

Low Noise Version

The unit is equipped with a compressor sound attenuating enclosure.

Pressure Gauges

A set of two pressure gauges per refrigerant circuit, one for low pressure and one for high pressure.

Flange Connection Kit

Provides a kit that includes a set of two pipe stubs and flange couplings.

Applications considerations

Optimum performance of CGWN and CCUN units will be achieved only if proper application guidelines are followed.

Where the application varies from the guidelines presented, it should be reviewed with your local Trane sales engineer.

Unit sizing

Intentionally oversizing a unit to assure adequate capacity is not recommended. Erratic system operation and excessive compressor cycling are often a direct result of an oversized unit. In addition, an oversized unit is usually more expensive to purchase, install and operate. If oversizing is desired, consider using two units.

Foundations

A special foundation is not required, provided the floor is flat, level and strong enough to support the unit's weight (see «General data» tables).

Sound insulation

4 or 6 vibration isolators are supplied as standard. They will be inserted between the floor and the unit to attenuate vibration. An acoustics engineer should always be consulted when noise is a critical factor.

Water drain

Ensure that near the unit is a large enough drain to evacuate the water when from the system emptying the unit for shutdown or repair.

Water connection

Units are supplied as standard with 3» male Victaulic connections. Should flange connection be used, use the adapted connection kit available. It is not allowed to weld on Victaulic connections.

Minimum water volume

The minimum recommended water volume depends on the type of application.

If necessary, provide a buffer tank. The control and safety devices are only certain to operate correctly if the system's water volume is sufficient.

Table 1 – Minimum installation water volume recommended

	Comfort Application			Process cooling Application		
	2°C Dead band (1)	3°C Dead band (2)	4°C Dead band (3)	2°C Dead band (1)	3°C Dead band (2)	4°C Dead band (3)
CGWN - CCUN 205	660 l	440 l	330 l	1160 l	730 l	530 l
CGWN - CCUN 206	670 l	450 l	340 l	1160 l	740 l	540 l
CGWN - CCUN 207	650 l	440 l	330 l	1100 l	710 l	520 l
CGWN - CCUN 208	880 l	580 l	440 l	1520 l	960 l	710 l
CGWN - CCUN 209	1060 l	700 l	530 l	1860 l	1170 l	860 l
CGWN - CCUN 210	1080 l	720 l	540 l	1870 l	1190 l	870 l
CGWN - CCUN 211	1260 l	840 l	630 l	2220 l	1400 l	1020 l
CGWN - CCUN 212	1260 l	840 l	630 l	2170 l	1380 l	1010 l
CGWN - CCUN 213	1050 l	700 l	530 l	1760 l	1130 l	830 l
CGWN - CCUN 214	1270 l	850 l	640 l	2150 l	1370 l	1010 l
CGWN - CCUN 215	1240 l	820 l	620 l	2060 l	1330 l	980 l

Notes

(1) Minimum water loop volume in order to obtain maximum +/- 1°C chilled water temperature fluctuation vs. Chilled water set-point

(2) Minimum water loop volume in order to obtain maximum +/- 1.5°C chilled water temperature fluctuation vs. Chilled water set-point

(3) Minimum water loop volume in order to obtain maximum +/- 2°C chilled water temperature fluctuation vs. Chilled water set-point

This table is estimated with

- Condenser : Water 30°/35°C

- Evaporator : Water 12°/7°C

Applications considerations

Water treatment

The use of untreated or improperly treated water in chillers may result in scaling, erosion, corrosion or algae. It is recommended that the services of a qualified water-treatment specialist be obtained to determine what water treatment, if any, is advisable. Trane assumes no responsibility for the results of untreated, or improperly treated water.

Flow rate limits

The minimum and maximum flow rates are indicated in the «Hydraulic data» charts section. Too low a flow rate may cause freezing of the evaporator. Too high a flow rate may cause erosion of the evaporator and very substantial pressure losses.

Operating Range

Figure 1 – CGWN operating limits

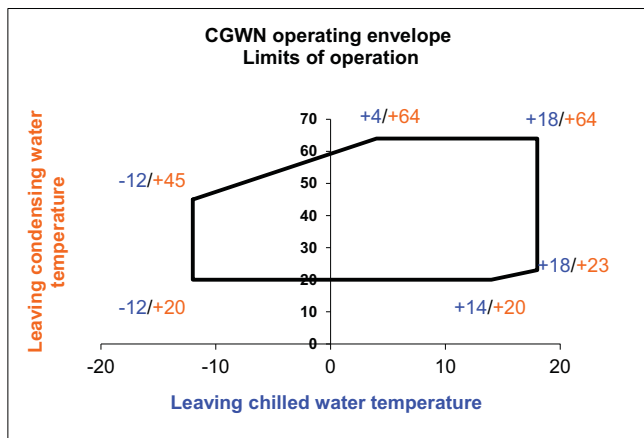
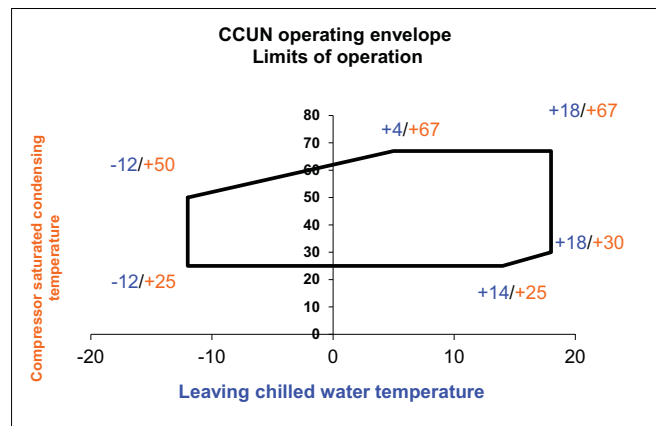

Figure 2 – CCUN operating limits



Note: CGWN 205 to 211 have a maximum condenser leaving water temperature of 60°C.

Applications considerations

Split systems piping recommendations

Maximum distances and refrigerant line diameters between units must be checked according to the configuration and system operating conditions (Chilled water temperature and subcooling). Tables 2 to 4 provide the maximum acceptable height according to subcooling available and recommended diameters for discharge liquid lines.

Figure 3 – Installation configuration - CCUN and remote condensing unit at the same level

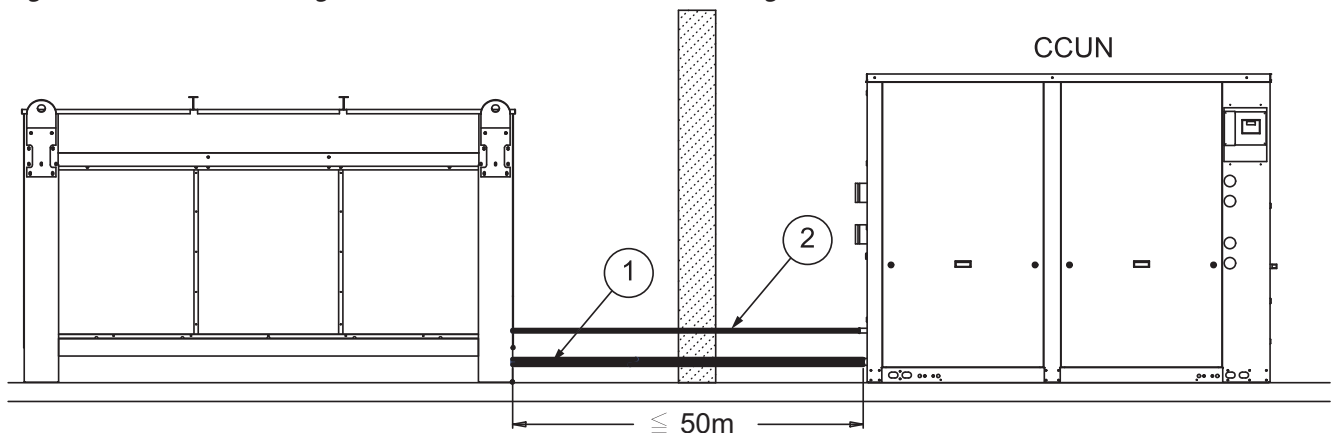

1: Discharge line

2: Liquid line

Table 2 – Recommended discharge line diameters for horizontal risers (Circuit 1)

		Required discharge pipe diameter - Circuit 1													
Unit size		-12	-10	-8	-6	-4	-2	0	2	4	6	8	10	12	14
CCUN	205			7/8"						1"1/8				1"3/8	
CCUN	206		7/8"					1"1/8						1"3/8	
CCUN	207		7/8"					1"1/8						1"3/8	
CCUN	208			1"1/8						1"3/8					1"5/8
CCUN	209			1"1/8						1"3/8					1"5/8
CCUN	210			1"1/8						1"3/8					1"5/8
CCUN	211			1"1/8						1"3/8					1"5/8
CCUN	212			1"5/8							2"1/8				
CCUN	213			1"5/8							2"1/8				
CCUN	214		1"5/8					2"1/8						2"5/8	
CCUN	215		1"5/8					2"1/8						2"5/8	

Table 3 – Recommended discharge line diameters for horizontal risers (Circuit 2)

		Required discharge pipe diameter - Circuit 2													
Unit size		-12	-10	-8	-6	-4	-2	0	2	4	6	8	10	12	14
CCUN	205			7/8"						1"1/8				1"3/8	
CCUN	206		7/8"					1"1/8						1"3/8	
CCUN	207		7/8"					1"1/8						1"3/8	
CCUN	208			1"1/8						1"3/8					1"5/8
CCUN	209			1"1/8						1"3/8					1"5/8
CCUN	210			1"1/8						1"3/8					1"5/8
CCUN	211			1"1/8						1"3/8					1"5/8
CCUN	212		1"3/8				1"5/8						2"1/8		
CCUN	213			1"5/8							2"1/8				
CCUN	214			1"5/8							2"1/8				
CCUN	215		1"5/8					2"1/8						2"5/8	



Applications considerations

Table 4 – Recommended liquid line diameters for vertical or horizontal risers (Circuit 1)

		Required liquid line pipe diameter - Circuit 1													
Unit size		-12	-10	-8	-6	-4	-2	0	2	4	6	8	10	12	14
CCUN	205			5/8"							7/8"			1"1/8	
CCUN	206	5/8"				7/8"							1"1/8		
CCUN	207	5/8"				7/8"							1"1/8		
CCUN	208			7/8"					1"1/8					1"3/8	
CCUN	209			7/8"					1"1/8					1"3/8	
CCUN	210		7/8"				1"1/8						1"3/8		
CCUN	211		7/8"				1"1/8						1"3/8		
CCUN	212		1"1/8						1"3/8					1"5/8	
CCUN	213		1"1/8						1"3/8					1"5/8	
CCUN	214		1"1/8				1"3/8						1"5/8		
CCUN	215		1"1/8				1"3/8						1"5/8		

Table 5 – Recommended liquid line diameters for vertical or horizontal risers (Circuit 2)

		Required liquid pipe diameter - Circuit 2													
Unit size		-12	-10	-8	-6	-4	-2	0	2	4	6	8	10	12	14
CCUN	205			5/8"							7/8"			1"1/8	
CCUN	206	5/8"				7/8"							1"1/8		
CCUN	207	5/8"				7/8"							1"1/8		
CCUN	208			7/8"					1"1/8					1"3/8	
CCUN	209			7/8"					1"1/8					1"3/8	
CCUN	210		7/8"				1"1/8						1"3/8		
CCUN	211		7/8"				1"1/8						1"3/8		
CCUN	212			1"1/8							1"3/8				
CCUN	213		1"1/8						1"3/8					1"5/8	
CCUN	214		1"1/8						1"3/8					1"5/8	
CCUN	215		1"1/8				1"3/8						1"5/8		

Safety Controls

A centralized microcomputer offers a higher level of machine protection. Because the safety controls are smarter, they limit compressor operation in order to avoid compressor or evaporator failures, thereby minimizing nuisance shutdowns. Tracer™ Chiller Controls directly senses the control variables that govern the operation of the chiller: evaporator pressure, condenser pressure. When any one of these variables approaches a limit condition at which the unit may be damaged or shut down on a safety, Tracer Chiller Controls takes corrective action to avoid shutdown and keep the chiller operating. It does this through combined actions of compressor staging and pump staging. It has also the capability to control the remote condenser fan staging for condenserless unit (CCUN). Tracer Chiller Controls optimizes total chiller power consumption during normal operating conditions. During abnormal operating conditions, the microprocessor will continue to optimize chiller performance by taking the corrective action necessary to avoid shutdown. This keeps cooling capacity available until the problem can be solved. Whenever possible, the chiller is allowed to perform its function: make chilled water. In addition, microcomputer controls allow for more types of protection, like winter freeze protection; the safety controls help keep the building or process running and out of trouble.

Stand-alone controls

Interfacing to stand-alone units is very simple: only a remote auto/stop for scheduling is required for unit operation. Signals from the chilled-water pump contactor auxiliary, or a flow switch, are wired to the chilled-water flow interlock. Signals from a time clock or some other remote device are wired to the external auto/stop input.

Tracer™ Chiller Control human interfaces



Standard Features External Auto/Stop

A job-site-provided contact closure will turn the unit on and off.

Chilled Waterflow Interlock

Unit is equipped with a water flow control which allows unit operation if a load exists. This feature will allow the unit to run in conjunction with the pump system.

External Interlock

A job-site-provided contact opening wired to this input will turn the unit off and require a manual reset of the unit microcomputer. This closure is typically triggered by a job-site-provided system such as a fire alarm.

Chilled Water Pump Control

Unit controller manage operation of the optional chilled and hot water pump of the chiller. When hydraulic modules are not mounted, unit controls provide an output to control the chilled-water pump(s). One contact closure to the chiller is all that is required to initiate the chilled-water system. Chilled water pump control by the chiller is a requirement for all Indoor AquaStream²® chillers.

Seven day scheduling

This function provides a means of scheduling the chiller operation on a daily basis. Thus simple chiller scheduling can be performed without the need for a building automation system.

Alarm Indication Contacts

Four factory-installed contacts with the following preset default assignments:

- Alarm
- Chiller running
- Maximum capacity
- Chiller limit.

Additional Features that May Be Added (require some optional factory-installed hardware)

- Ice-making card
- Tracer communication card
- Chilled water and remote current limit set point card (note: all wiring outside the unit is supplied by the contractor).



Control

Easy Interface to a Generic Building Management System

Controlling the Indoor AquaStream²® chillers with building management systems is state-of-the-art, yet simple with either:

- the LonTalk Communications Interface for Chillers (LCI-C)
- or Generic Building Management System Hardware Points.

Simple Interface with Other Control Systems

Microcomputer controls afford simple interface with other control systems, such as time clocks, building automation systems, and ice storage systems. This means you have the flexibility to meet job requirements while not having to learn a complicated control system. This setup has the same standard features as a stand-alone water chiller, with the possibility of having additional optional features.

What are LonTalk, Echelon, and LonMark?

LonTalk is a communications protocol developed by the Echelon Corporation. The LonMark association develops control profiles using the LonTalk communication protocol. LonTalk is a unit level communications protocol, unlike BACNet used at the system level.

LonTalk Communications Interface for Chillers (LCI-C)

LonTalk Communications Interface for Chillers (LCI-C) provides a generic automation system with the LonMark chiller profile inputs/outputs. The inputs/outputs include both mandatory and optional network variables.

Note: LonMark network variable names are in parentheses when different from chiller naming convention.

Chiller Inputs:

- Chiller Enable/Disable
- Chilled Liquid Setpoint (Cool or hot Setpoint)
- Ice Making (Chiller Mode)

Chiller Enable/Disable

Allows the chiller to be started or stopped depending on if certain operating conditions are met.

Chilled Liquid Setpoint

Allows the the external setting independent of the front panel setpoint to adjust the leaving water temperature setpoint.

Hot Liquid Setpoint

Allows the external setting independent of the front panel setpoint to adjust the leaving water temperature setpoint from the condenser.

Ice Making

Provides interface with ice making control systems.

Chiller Outputs:

- On/Off Active Setpoint
- Leaving Chilled Water Temperature
- Entering Chilled Water Temperature
 - Leaving Hot Water Temperature
 - Entering Hot Water Temperature
- Alarm Descriptor
- Chiller Status

On/Off

Indicates the current state of the chiller.

Active Setpoint

Indicates the current value of the leaving water temperature setpoint.

Leaving Chilled Water Temperature

Provides the current leaving water temperature.

Entering Chilled Water Temperature

Provides the current entering water temperature.

Leaving Hot Water Temperature (Optional feature)

Provides the current leaving water temperature from the condenser.

Entering Hot Water Temperature (Optional feature)

Provides the current entering water temperature from the condenser.

Alarm Descriptor

Provides alarm messages based on predetermined criteria.

Chiller Status

Indicates the running modes and states of the chiller, i.e. Running in alarm mode, chiller enabled, chiller being locally controlled, etc.

Generic Building Management System Hardwire Points

GBAS may be achieved via hardware input/output as well. The input/outputs are as follows:

Chiller hardware inputs include:

- Chiller enable/disable
- Circuit enable/disable

- External chilled water setpoint - (Optional feature)
- Ice making enable – (Optional feature)

External Chilled Water Setpoint - (Optional feature)

Allows the external setting independent of the front panel setpoint by one of two means:

- a) 2-10 VDC input, or
- b) 4-20 mA input

Chiller hardware outputs include:

- Compressor running indication
- Alarm indication (Ckt 1/Ckt 2)
- Maximum capacity
- Ice making status

Alarm Indication Contacts

The unit provides three single-pole/ double-throw contact closures to indicate:

- a) Compressor on/off status
- b) Compressor running at maximum capacity
- c) Failure has occurred (Ckt 1/Ckt 2)

These contact closures may be used to trigger job site supplied alarm lights or alarm bells.

Ice Making Control - (Optional feature)

Provides interface with ice making control systems.

Tracer Summit™ Controls – Interface with the Trane Integrated Comfort System (ICS)**Trane Chiller Plant Control**

The Tracer Chiller Plant Manager building management system provides building automation and energy management functions through stand-alone control. The Chiller Plant Control is capable of monitoring and controlling your entire chiller plant system.

Application software available:

- Time-of-day scheduling
- Chiller sequencing
- Process control language
- Boolean processing
- Zone control
- Reports and logs
- Custom messages
- Run time and maintenance
- Trend log
- PID control loops

And of course, the Trane Chiller Plant Control can be used on a stand-alone basis or tied into a complete building automation system. When the water-cooled chiller is used in conjunction with a Trane Tracer Summit™ system, the unit can be monitored and controlled from a remote location. The water-cooled chiller can be controlled to fit into the overall building automation strategy by using time-of-day scheduling, timed override, demand limiting, and chiller sequencing. A building owner can completely monitor the water-cooled chiller from the Tracer system, since all of the monitoring information indicated on the microcomputer can be read on the unit controllers Tracer system display. In addition, all the powerful diagnostic information can be read back at the Tracer system. Best of all, this powerful capability comes over a single twisted pair of wires! Water-Cooled chillers can interface with many different external control systems, from simple stand-alone units to ice-making systems. Each unit requires a single-source, three-phase power supply.

A single twisted pair of wires tied directly between the Indoor AquaStream²® chillers and a Tracer Summit™ system provides control, monitoring, and diagnostic capabilities. Control functions include auto/stop, adjustment of leaving-water-temperature set point and control of ice-making mode. The Tracer system reads monitoring information such as entering- and leaving- evaporator-water temperatures and entering- and leaving-condenser-water temperatures and outdoor air temperature. Over 60 individual diagnostic codes can be read by the Tracer system. In addition, the Tracer system can provide sequencing control for up to 25 units on the same chilled-water loop. Pump sequencing control can be provided from the Tracer system. Tracer ICS is not available in conjunction with the external set point capability.



Control

Required Options

Tracer Interface

Additional Options that May Be Used

Ice-Making Control

External Trane Devices Required

Tracer Summit™, Tracer 100 System or Tracer Chiller Plant Control

Ice-Making Systems Controls

An ice-making option may be ordered with the water-cooled chiller. The unit will have two operating modes, ice making and normal daytime cooling. In the ice making mode, the water-cooled chiller will operate at full compressor capacity until the return chilled-fluid temperature entering the evaporator meets the ice making set point. Two input signals are required to the water-cooled chiller for the ice-making option. The first is an auto/stop signal for scheduling, and the second is required to switch the unit between the ice-making mode and normal daytime operation. The signals are provided by a remote job site building-automation device such as a time clock or a manual switch. In addition, the signals may be provided over the twisted wire pair from a Tracer™ system, or a LonTalk Communication Interface but will require the communication boards provided with the Ice Making Control Option.

Additional Options That May Be Used

- Failure Indication Contacts Communications Interface (For Tracer Systems)
- Chilled-Water Temperature Reset

Selection Procedures

The performance examples, on the following pages provide performance information at various capacities for the most common conditions.

The stated cooling capacities are based on:

	Evaporator Δt (°C)	Condenser Δt (°C)	Fouling factor (m ² /K/kW)
CGWN Water cooled chillers	5	5	0.0044
CCUN Condenserless chillers	5	-	0.0044
CCUN + remote condensing unit Split system	5	-	0.0044

The capacity ratings are applicable to a temperature drop within 4 to 8°C except as limited by the minimum or maximum water-flow rates as indicated by the heat exchanger's hydraulic resistance tables. If a different fouling factor is used, the unit capacity will vary. For conditions that are not directly tabulated, direct interpolation may be used. Extrapolation is not permitted.

Watercooled units: CGWN

To determine the cooling capacity and the power input, the following information is needed:

- the required cooling capacity (Cap.)
- the evaporator leaving water temperature (ELWT)
- the condenser leaving water temperature (CLWT)

Unit power input (P.I.), heat rejected by condenser (RH), evaporator and condenser waterflow rates (respectively EWFR and CWFR) and associated pressure drops (respectively EWPD and CWPD) are given in the table.

Selection example:

Cooling capacity required (Cap): 180 kW.

Evaporator leaving water temperature (ELWT): 7°C.

Condenser leaving water temperature (CLWT): 35°C.

By using the selection table it can be determined that the CGWN 205 Standard gives a cooling capacity (cap) of 182.5 kW and a power input (P.I.) of 42.5 kW and condenser rejected heat (RH) is 224.19 kW.

Evaporator water flow rate (EWFR) is 8.71 l/s and associated pressure drop (EWPD) is 57 kPa.

Condenser water flow rate (CWFR) is 10.70 l/s and associated pressure drop (CWPD) is 59 kPa.

Performances

Table 6 – Correction factors to apply when glycol is used in water loops

Fluid Type	Glycol Concentration		Performance		Evaporator		Condenser	
	Evaporator	Condenser	F-CC	F-PI	F-FLEVP	F-PDEVP	F-FLCDS	F-PDCDS
Water only	0%	0%	1.00	1.00	1.00	1.00	1.00	1.00
	10%	0%	0.99	1.00	1.02	1.02	1.00	1.00
	20%	0%	0.98	1.00	1.05	1.06	1.00	1.00
Ethylene Glycol	30%	0%	0.97	1.00	1.10	1.10	1.00	1.00
	0%	10%	1.00	1.00	1.00	1.00	1.02	1.05
	0%	20%	1.00	1.01	1.00	1.00	1.04	1.09
	0%	30%	1.00	1.02	1.00	1.00	1.08	1.14
	10%	0%	0.99	1.00	1.01	1.05	1.00	1.01
	20%	0%	0.97	1.00	1.03	1.10	1.00	1.00
Mono-Propylene Glycol	30%	0%	0.96	1.00	1.05	1.17	1.00	1.01
	0%	10%	1.00	1.01	1.00	1.00	1.01	1.06
	0%	20%	1.00	1.01	1.00	1.00	1.02	1.13
	0%	30%	0.99	1.02	1.00	1.00	1.05	1.21

The correction factors found in Table 6 can be applied as follows:

- 1) **Cooling capacity** with glycol [kW] = **F-CC** x Cooling capacity water [kW] (found in tables 6 to 13)
- 2) **Power Input** with glycol [kW] = **F-PI** x Power Input water [kW] (found in tables 6 to 13)
- 3) **Water Flow Evaporator** with glycol [Litres/sec] = **F-FLEVP** x Cooling capacity with glycol [kW] x 0.239 x (1 / Delta T Evaporator [°C])
- 4) **Water Pressure drop Evaporator** with glycol [kPa] = **F-PDEVP** x Water Pressure drop Evaporator water [kPa] (found in figures 6 and 7)

CGWN Only:

- 5) **Water Flow Condenser** with glycol [Litres/sec] = **F-FLCDS** x (Cooling capacity with glycol [kW] + Power input with glycol [kW]) x 0.239 x (1 / Delta T Condenser [°C])
- 6) **Water Pressure drop Condenser** with glycol [kPa] = **F-PDCDS** x Water Pressure drop Condenser water [kPa] (found in figures 8 and 9)

In case of application with negative temperature at the evaporator, combination of simultaneous usage of glycol both in evaporator and condenser, or usage of another type of fluid: please contact your local Trane sales representative.

Table 7 – European Seasonal Energy Efficiency Ratio (ESEER)

Model	ESEER	A	B	C	D
		100% load EER	75% load EER	50% load EER	25% load EER
CGWN 205 SE	4.55	4.04	4.75	4.37	4.63
CGWN 205 HE	5.81	4.63	5.37	6.27	5.75
CGWN 206 SE	4.59	4.1	4.73	4.53	4.58
CGWN 206 HE	5.21	4.52	5.19	5.16	5.41
CGWN 207 SE	4.75	4.06	4.86	4.58	4.99
CGWN 207 HE	5.31	4.48	5.29	5.15	5.73
CGWN 208 SE	5.76	4.37	5.19	6.38	5.66
CGWN 209 SE	5.24	4.18	4.85	5.68	5.14
CGWN 210 SE	4.72	4.1	4.83	4.6	4.86
CGWN 211 SE	4.87	4.2	4.91	4.69	5.21
CGWN 212 SE	5.45	4.38	5.09	5.7	5.67
CGWN 213 SE	5.33	4.32	5	5.58	5.49
CGWN 214 SE	5.33	4.31	4.98	5.54	5.58
CGWN 215 SE	5.33	4.29	5	5.52	5.59

General data

Table 8 – General data - CGWN/CCUN R410A

Unit size		205	206	207	208	209	210	211	212	213	214	215
Standard Efficiency												
Cooling mode												
Net Capacity	(kW)	182.0	216.0	251.0	283.1	282.0	311.0	341.0	411	444	477	506
Evaporator water pressure drop	(kPa)	57.6	59.0	55.6	42	42.4	41.8	49.8	44	43	43	42
Evaporator head pressure available (6)	(kPa)	161	141	142	149	143	188	176	224	212	214	204
Condenser water pressure drop	(kPa)	59	65	61	47	47.9	52.8	63.4	64	74	73	82
Condenser head pressure available (6)	(kPa)	151	134	138	162	150	132	117	173	161	157	143
Heating mode												
Net Capacity	(kW)	214	254.8	296.2	329.1	362.0	400.8	441.8	478.9	518.1	557.3	591.2
Evaporator water pressure drop	(kPa)	46	47	45	34	30	40	48	50	50	50	49
Evaporator head pressure available (6)	(kPa)	182	167	156	163	160	204	193	250	229	217	205
Condenser water pressure drop	(kPa)	54	60	56	44	48	51	62	57	65	65	73
Condenser head pressure available (6)	(kPa)	157	141	159	167	158	140	124	193	182	169	156
High Efficiency												
Cooling mode												
Net Capacity	(kW)	193.0	227.0	262.0	-	-	-	-	-	-	-	-
Evaporator water pressure drop	(kPa)	26.1	35.7	36.6	-	-	-	-	-	-	-	-
Evaporator head pressure available (6)	(kPa)	188	156	160	-	-	-	-	-	-	-	-
Condenser water pressure drop	(kPa)	31	43	41	-	-	-	-	-	-	-	-
Condenser head pressure available (6)	(kPa)	177	154	173	-	-	-	-	-	-	-	-
Heating mode												
Net Capacity	(kW)	221	262	303	-	-	-	-	-	-	-	-
Evaporator water pressure drop	(kPa)	21	28	29	-	-	-	-	-	-	-	-
Evaporator head pressure available (6)	(kPa)	203	180	170	-	-	-	-	-	-	-	-
Condenser water pressure drop	(kPa)	28	39	38	-	-	-	-	-	-	-	-
Condenser head pressure available (6)	(kPa)	180	159	177	-	-	-	-	-	-	-	-
System Data												
Refrigerant circuit		2	2	2	2	2	2	2	2	2	2	2
Capacity steps		4	4	4	4	4	4	4	6	6	6	6
Minimum capacity	%	25	21	25	22	25	23	25	17	17	17	17
Units Amps (2) (4)												
Nominal (3)	(A)	131	146	161	182	203	219	235	262	282	303	319
Start-up Amps												
Standard unit	(A)	259	321	336	392	413	481	497	472	492	513	581
With soft starter option	(A)	195	235	250	288	309	353	369	368	388	409	453
Short circuit unit capacity	(kA)	15	15	15	15	15	15	15	15	15	15	15
Max supply cable size	(mm ²)	150	150	150	150	240	240	240	240	240	240	240
Compressor												
Number		4	4	4	4	4	4	4	6	6	6	6
Type		Scroll	Scroll	Scroll	Scroll	Scroll	Scroll	Scroll	Scroll	Scroll	Scroll	Scroll
Model		(15T+15T)	(15T+20T)	(20T+20T)	(20T+25T)	(25T+25T)	(25T+30T)	(30T+30T)	(20T+20T+25T)	(25T+20T+25T)	(25T+25T+25T)	(25T+25T+30T)
Number of speeds		1	1	1	1	1	1	1	1	1	1	1
Number of motors		1	1	1	1	1	1	1	1	1	1	1
Rated Amps (comp A/B/C) (5)	(A)	32/32	32/40	40/40	40/50	50/50	50/58	58/58	40/40/50	50/40/50	50/50/50	50/50/58
Locked rotor Amps (comp A/B/C)	(A)	160/160	160/215	215/215	215/260	260/260	260/320	320/320	215/215/260	260/215/260	260/260/260	260/260/320
Motor RPM	(rpm)	2900	2900	2900	2900	2900	2900	2900	2900	2900	2900	2900
Power factor (comp A/B/C)		0,81/0,81	0,81/0,87	0,87/0,87	0,87/0,86	0,86/0,86	0,86/0,86	0,89/0,89	0,87/0,86	0,86/0,87	0,86/0,86	0,86/0,86
Sump Heater (comp A/B/C)	(W)	160/160	160/160	160/161	160/162	160/163	160/164	160/165	160/160/160	160/160	160/161	160/162



General data

Unit size		205	206	207	208	209	210	211	212	213	214	215
Evaporator												
Number		1	1	1	1	1	1	1	1	1	1	1
Type		Brazed plate	Brazed plate	Brazed plate	Brazed plate	Brazed plate	Brazed plate	Brazed plate	Brazed plate	Brazed plate	Brazed plate	Brazed plate
Standard Efficiency Model		DP400-74	DP400-90	DP400-114	DP400-162	DP400-186	DP400-186	DP400-206	ACH502DQ-138	ACH502DQ-150	ACH502DQ-162	ACH502DQ-174
Water volume (total) (L)		15.6	18.9	24.0	34.1	39.2	39.2	43.4	35.9	39.0	42.1	45.2
High Efficiency Model		DP400-154	DP400-154	DP400-162	-	-	-	-	-	-	-	-
Water volume (total) (L)		32.4	32.4	34.1	-	-	-	-	-	-	-	-
Antifreeze Heater (W)		no	no	no	no	no	no	no	no	no	no	no
Condenser (CGWN)												
Number		1	1	1	1	1	1	1	2	2	2	2
Type		Brazed plate	Brazed plate	Brazed plate	Brazed plate	Brazed plate	Brazed plate	Brazed plate	Brazed plate	Brazed plate	Brazed plate	Brazed plate
Standard Efficiency Model		DP400-90	DP400-114	DP400-134	DP400-186	DP400-206	DP400-206	DP400-222	B400T-114	B400T-114	B400T-130	B400T-130
Water volume (total) (L)		19	24	28	39	43	43	47	23	23	26	26
High Efficiency Model		DP400-162	DP400-162	DP400-186	-	-	-	-	-	-	-	-
Water volume (total) (L)		34.1	34.1	39.2	-	-	-	-	-	-	-	-
Antifreeze Heater (W)		no	no	no	no	no	no	no	no	no	no	no
Condenserless Unit (CCUN)												
Discharge line diameter circuit 1 & 2		1"3/8	1"3/8	1"3/8	1"5/8	1"5/8	1"5/8	1"5/8	1"5/8	1"5/8	1"5/8	1"5/8
Liquid line diameter circuit 1 & 2		7/8	7/8	7/8	7/8	7/8	1"1/8	1"1/8	1"3/8	1"3/8	1"3/8	1"3/8
Hydraulic Module / Evaporator Side (Option high head)												
Pump Type (Single)		LRL	LRL	LRN	LRN	LRN	LRN	LRN	SIL	SIL	SIL	SIL
Model		205 - 15 / 4	205 - 15 / 4	206 - 13 / 5.5	206 - 13 / 5.5	206 - 13 / 5.5	206 - 14 / 7.5	206 - 14 / 7.5	208 - 16 / 11	208 - 16 / 11	208 - 16 / 11	208 - 16 / 11
Pump Type (Dual)		JRL	JRL	JRN	JRN	JRN	JRN	JRN	DIL	DIL	DIL	DIL
Model		205 - 15 / 4	205 - 15 / 4	206 - 13 / 5.5	206 - 13 / 5.5	206 - 13 / 5.5	206 - 14 / 7.5	206 - 14 / 7.5	208 - 16 / 11	208 - 16 / 11	208 - 16 / 11	208 - 16 / 11
Number of Pump sets		1	1	1	1	1	1	1	1	1	1	1
Motor (6) (kW)		4.0	4.0	5.5	5.5	5.5	7.5	7.5	11.0	11.0	11.0	11.0
Rated Amps (6) (A)		7.5	7.5	10.5	10.5	10.5	14.3	14.3	20.0	20.0	20.0	20.0
Motor RPM (rpm)		2900	2900	2900	2900	2900	2900	2900	2900	2900	2900	2900
Water strainer Ø		3"	3"	4"	4"	4"	4"	4"	4"	4"	4"	4"
Expansion tank volume (L)		25	25	25	25	25	25	25	35	35	35	35
User volume expansion capacity (6) (L)		3600	3600	3600	3600	3600	3600	3600	5100	5100	5100	5100
Max. water-side operating pressure,												
without hydraulic module (kPa)		1000	1000	1000	1000	1000	1000	1000	1000	1000	1000	1000
with hydraulic module (kPa)		400	400	400	400	400	400	400	400	400	400	400
Antifreeze heater (W)		no	no	no	no	no	no	no	no	no	no	no
Piping		Steel	Steel	Steel	Steel	Steel	Steel	Steel	Steel	Steel	Steel	Steel
Hydraulic Module / Evaporator Side (Option low head)												
Pump Type (Single)		LRL	LRL	SIL	SIL	SIL	LRN	LRN	LRN	LRN	LRN	LRN
Model		205 - 13 / 2.2	205 - 13 / 2.2	206 - 12 / 4.0	206 - 12 / 4.0	206 - 12 / 4.0	206 - 13 / 5.5	206 - 13 / 5.5	206 - 13 / 5.5	206 - 13 / 5.5	206 - 14 / 7.5	206 - 14 / 7.5
Pump Type (Dual)		JRL	JRL	DIL	DIL	DIL	JRN	JRN	JRN	JRN	JRN	JRN
Model		205 - 13 / 2.2	205 - 13 / 2.2	206 - 12 / 4.0	206 - 12 / 4.0	206 - 12 / 4.0	206 - 13 / 5.5	206 - 13 / 5.5	206 - 13 / 5.5	206 - 13 / 5.5	206 - 14 / 7.5	206 - 14 / 7.5
Number of Pump sets		1	1	1	1	1	1	1	1	1	1	1
Motor (6) (kW)		2.2	2.2	4.0	4.0	4.0	5.5	5.5	4.0	4.0	5.5	5.5
Rated Amps (6) (A)		4.9	4.9	7.8	7.8	7.8	10.5	10.5	7.8	7.8	10.3	10.3
Motor RPM (rpm)		2900	2900	2900	2900	2900	2900	2900	2900	2900	2900	2900

General data

Unit size		205	206	207	208	209	210	211	212	213	214	215
Hydraulic Module / Condenser Side (Option high head)												
Pump Type		SHC	SHC	SHC	SHC	SHC	SHC	SHC	JRN	JRN	JRN	JRN
Model high head		35 - 135 / 3	35 - 135 / 3	50 - 135 / 4	50 - 135 / 4	50 - 135 / 4	50 - 135 / 4	50 - 135 / 4	206 - 14 / 7.5	206 - 14 / 7.5	206 - 14 / 7.5	206 - 14 / 7.5
Number of Pump sets		2 (in parallel)	2 (in parallel)	3 (in parallel)	4 (in parallel)	5 (in parallel)	6 (in parallel)	7 (in parallel)	2 (in parallel)	2 (in parallel)	2 (in parallel)	2 (in parallel)
Motor (6)	(kW)	3.0	3.0	4.0	4.0	4.0	4.0	4.0	7.5 (x2)	7.5 (x2)	7.5 (x2)	7.5 (x2)
Rated Amps (6)	(A)	6.2	6.2	7.4	7.4	7.4	7.4	7.4	13.8	13.8	13.8	13.8
Motor RPM	(rpm)	2900	2900	2900	2900	2900	2900	2900	2900	2900	2900	2900
Water strainer Ø		4"	4"	4"	4"	4"	4"	4"	4"	4"	4"	4"
Expansion tank volume	(L)	No	No	No	No	No	No	No	No	No	No	No
Max. water-side operating pressure,												
without hydraulic module	(kPa)	1000	1000	1001	1002	1003	1004	1005	1000	1000	1000	1000
with hydraulic module suction/discharge	(kPa)	400/640	400/640	400/641	400/642	400/643	400/644	400/645	1000	1000	1000	1000
Antifreeze heater	(W)	no	no	no	no	no	no	no	no	no	no	no
Piping		Steel	Steel	Steel	Steel	Steel	Steel	Steel	Steel	Steel	Steel	Steel
Hydraulic Module / Condenser Side (Option low head)												
Pump Type		SHC	SHC	SHC	SHC	SHC	SHC	SHC	DIL	DIL	JRN	JRN
Model high head		20 -134 / 2.2	20 -134 / 2.2	35 - 135 / 3	35 - 135 / 3	35 - 135 / 3	35 - 135 / 3	35 - 135 / 3	206 - 12 / 4.0	206 - 12 / 4.0	206 - 13 / 5.5	206 - 13 / 5.5
Number of Pump sets		2 (in parallel)	2 (in parallel)	3 (in parallel)	4 (in parallel)	5 (in parallel)	6 (in parallel)	7 (in parallel)	8 (in parallel)	9 (in parallel)	10 (in parallel)	11 (in parallel)
Motor (6)	(kW)	2.2	2.2	3.0	3.0	3.0	3.0	3.0	4.0	4.0	5.5	5.5
Rated Amps (6)	(A)	5.0	5.0	6.2	6.2	6.2	6.2	6.2	7.8	7.8	10.3	10.3
Motor RPM	(rpm)	2900	2900	2900	2900	2900	2900	2900	2900	2900	2900	2900
Unit water connection												
Chilled water	(Inch/ mm)	3" (80)	3" (80)	4" (100)	4" (100)	4" (100)	4" (100)	4" (100)	4" (100)	4" (100)	4" (100)	4" (100)
Type		Victaulic	Victaulic	Victaulic	Victaulic	Victaulic	Victaulic	Victaulic	Victaulic	Victaulic	Victaulic	Victaulic
Hot water High Head	(Inch/ mm)	4" (100)	4" (100)	4" (100)	4" (100)	4" (100)	4" (100)	4" (100)	5" (125)	5" (125)	5" (125)	5" (125)
Type		Victaulic	Victaulic	Victaulic	Victaulic	Victaulic	Victaulic	Victaulic	Victaulic	Victaulic	Victaulic	Victaulic
Hot water Low Head	(Inch/ mm)	3" (80)	3" (80)	4" (100)	4" (100)	4" (100)	4" (100)	4" (100)	5" (125)	5" (125)	5" (125)	5" (125)
Type		Victaulic	Victaulic	Victaulic	Victaulic	Victaulic	Victaulic	Victaulic	Victaulic	Victaulic	Victaulic	Victaulic
Unit water connection without pumps												
Chilled water	(Inch/ mm)	3" (80)	3" (80)	4" (100)	4" (100)	4" (100)	4" (100)	4" (100)	4" (100)	4" (100)	4" (100)	4" (100)
Type		Victaulic	Victaulic	Victaulic	Victaulic	Victaulic	Victaulic	Victaulic	Victaulic	Victaulic	Victaulic	Victaulic
Hot water	(Inch/ mm)	3" (80)	3" (80)	4" (100)	4" (100)	4" (100)	4" (100)	4" (100)	5" (125)	5" (125)	5" (125)	5" (125)
Type		Victaulic	Victaulic	Victaulic	Victaulic	Victaulic	Victaulic	Victaulic	Victaulic	Victaulic	Victaulic	Victaulic
Dimensions												
Height	(mm)	1842	1842	1842	1842	1842	1842	1842	1950	1950	1950	1950
Length (without pumps)	(mm)	2545	2545	2545	2545	2545	2545	2545	2808	2808	2808	2808
Length (with pumps)	(mm)	2545	2545	2545	2545	2545	2545	2545	3498	3498	3498	3498
Width	(mm)	880	880	880	880	880	880	880	878	878	878	878
Standard Efficiency Operating Weight (CGWN/CCUN)												
Base Unit (without pumps)	(kg)	1360 / 1260	1300 / 1170	1420 / 1270	1500 / 1280	1650 / 1420	1710 / 1480	1790 / 1550	2232 / 1879	2442 / 2070	2525 / 2120	2640 / 2180
Base Unit (with pumps)	(kg)	1360 / 1260	1300 / 1170	1420 / 1270	1500 / 1280	1650 / 1420	1710 / 1480	1790 / 1550	2128 / 1880	2337 / 2071	2420 / 2122	2500 / 2182
Evap Hyd Kit	(kg)	1450 / 1350	1390 / 1260	1590 / 1440	1670 / 1450	1820 / 1590	1880 / 1650	1960 / 1720	2618 / 2370	2827 / 2561	2910 / 2612	2990 / 2672
Evap + Cds Hyd Kit	(kg)	1520 / NA1460 / NA1690 / NA1770 / NA1920 / NA1980 / NA2060 / NA2992 / NA3201 / NA3284 / NA3364 / NA										
Shipping Weight (CGWN/CCUN)												
Base Unit (without pumps)	(kg)	1290 / 1210	1220 / 1120	1320 / 1200	1370 / 1190	1510 / 1320	1570 / 1380	1650 / 1450	2109 / 1832	2315 / 2023	2387 / 2070	2492 / 2130
Evap Hyd Kit	(kg)	1380 / 1300	1310 / 1210	1490 / 1370	1540 / 1360	1680 / 1490	1740 / 1550	1820 / 1620	2480 / 2274	2685 / 2465	2758 / 2512	2840 / 2568
Evap + Cds Hyd Kit	(kg)	1450 / NA1380 / NA1590 / NA1640 / NA1780 / NA1840 / NA1920 / NA2797 / NA3002 / NA3075 / NA3157 / NA										

General data

Unit size		205	206	207	208	209	210	211	212	213	214	215
High Efficiency	Operating Weight (CGWN/CCUN)											
Base Unit (without pumps)	(kg)	1460/1330	1450/1240	1470/1250	-	-	-	-	-	-	-	-
Evap Hyd Kit	(kg)	1550/1420	1540/1330	1640/1420	-	-	-	-	-	-	-	-
Evap + Cds Hyd Kit	(kg)	1620/NA	1610/NA	1740/NA	-	-	-	-	-	-	-	-
	Shipping Weight (CGWN/CCUN)											
Base Unit (without pumps)	(kg)	1360/1270	1350/1170	1340/1160	-	-	-	-	-	-	-	-
Evap Hyd Kit	(kg)	1450/1360	1440/1260	1510/1330	-	-	-	-	-	-	-	-
Evap + Cds Hyd Kit	(kg)	1520/NA	1510/NA	1610/NA	-	-	-	-	-	-	-	-
Refrigerant Charge (4) (5)												
CGWN Standard Efficiency Circuit 1 & 2	(kg)	10	11	13	17	18	18	19	22	23	24	25
CGWN High Efficiency Circuit 1 & 2	(kg)	15	15	17	-	-	-	-	-	-	-	-
CCUN												
Oil Charge per circuit												
Circuit 1 & 2	(l)	13.4	13.4	13.4	13.4	13.4	13.9	14.4	21.2	21.7	22.2	22.7

(1) Indicative performance at Evaporator water temperature: 12°C / 7°C - Condenser 30°C/35°C or 40°C/45°C (heating) - for detailed performances consult Order Write Up.

(2) Under 400V/3/50Hz.

(3) Max Rated Condition without Pump Package.

(4) Electrical & system data are indicative and subject to change without notice. Please refer to unit nameplate data.

(5) Per circuit.

(6) Dual Pump Option.

General data

Table 9 – Evaporator hydraulic module

		205	206	207	208	209	210	211	212	213	214	215
High head pressure option												
Nb Pump set		1										
Motor (1)(2)	(kW)	4.0	4.0	5.5	5.5	5.5	7.5	7.5	11.0	11.0	11.0	11.0
Rated Amps (1)(2)	(A)	7.5	7.5	11.1	11.1	11.1	14.7	14.7	20.0	20.0	20.0	20.0
Motor RPM	(rpm)	2900										
Low head pressure option												
Nb Pump set		1										
Motor (1)(2)	(kW)	2.2	2.2	4.0	4.0	4.0	5.5	5.5	4.0	4.0	5.5	5.5
Rated Amps (1)(2)	(A)	4.0	4.0	7.5	7.5	7.5	11.1	11.1	7.8	7.8	10.3	10.3
Motor RPM	(rpm)	2900										
Expansion tank volume	(l)	25	25	25	25	25	25	25	35	35	35	35
User volume expansion capacity (3)	(l)	3600	3600	3600	3600	3600	3600	3600	5100	5100	5100	5100
Water strainer diameter		3"	3"	4"	4"	4"	4"	4"	4"	4"	4"	4"
Piping		Steel										

Table 10 – Condenser hydraulic module

		205	206	207	208	209	210	211	212	213	214	215
High head pressure option												
Nb Pump set		2 (in parallel)										
Motor (1)(2)	(kW)	3	3	4	4	4	4	4	7.5	7.5	7.5	7.5
Rated Amps (1)(2)	(A)	6.1	6.1	7.7	7.7	7.7	7.7	7.7	13.8	13.8	13.8	13.8
Motor RPM	(rpm)	2900										
Low head pressure option												
Nb Pump set		2 (in parallel)										
Motor (1)(2)	(kW)	2.2	2.2	3.0	3.0	3.0	3.0	3.0	4.0	4.0	5.5	5.5
Rated Amps (1)(2)	(A)	4.2	4.2	6.1	6.1	6.1	6.1	6.1	7.8	7.8	10.3	10.3
Motor RPM	(rpm)	2900										
Water strainer diameter		4"	4"	4"	4"	4"	4"	4"	4"	4"	4"	4"
Piping		Steel										

(1) Per motor

(2) Dual Pump Option

(3) Hydrostatic pressure 3 bar at 25°C with 7°C mini

Hydraulic data

Figure 4 – Standard and High Efficiency units evaporator pressure drop

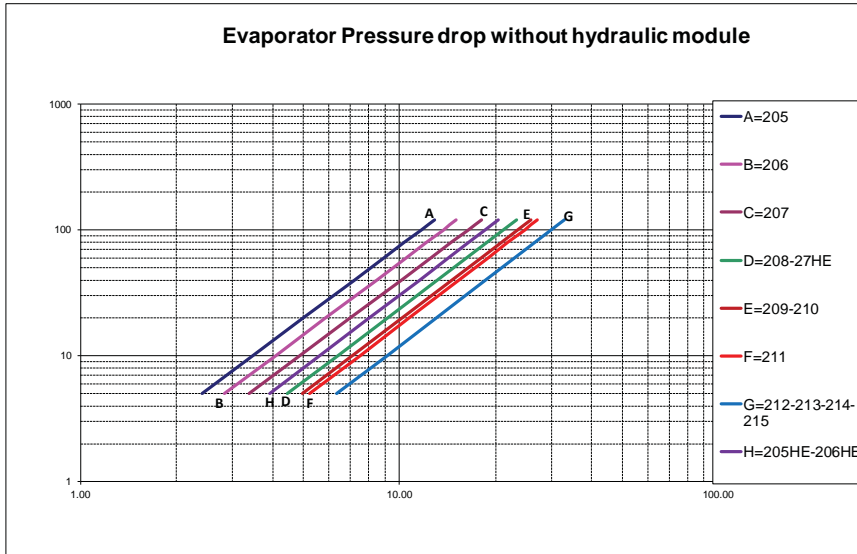

EWFR : Evaporator Waterflow Rate

EWPD : Evaporator Water Pressure Drop

Figure 5 – Standard units condenser pressure drop

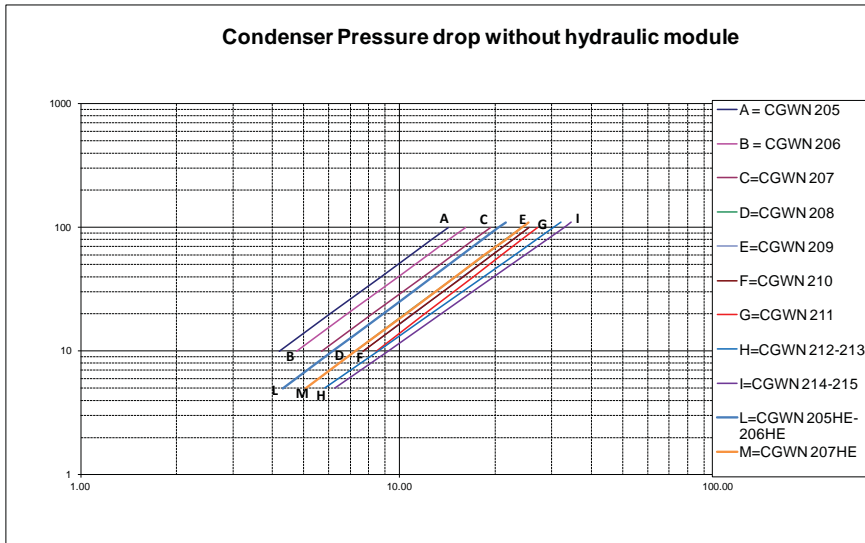

CWFR : Condenser Waterflow Rate

CWPD : Condenser Water Pressure Drop

Hydraulic data

Figure 6 – Chiller available pressure - Evaporator side - Standard and High Efficiency units - Low head pressure - Single pump

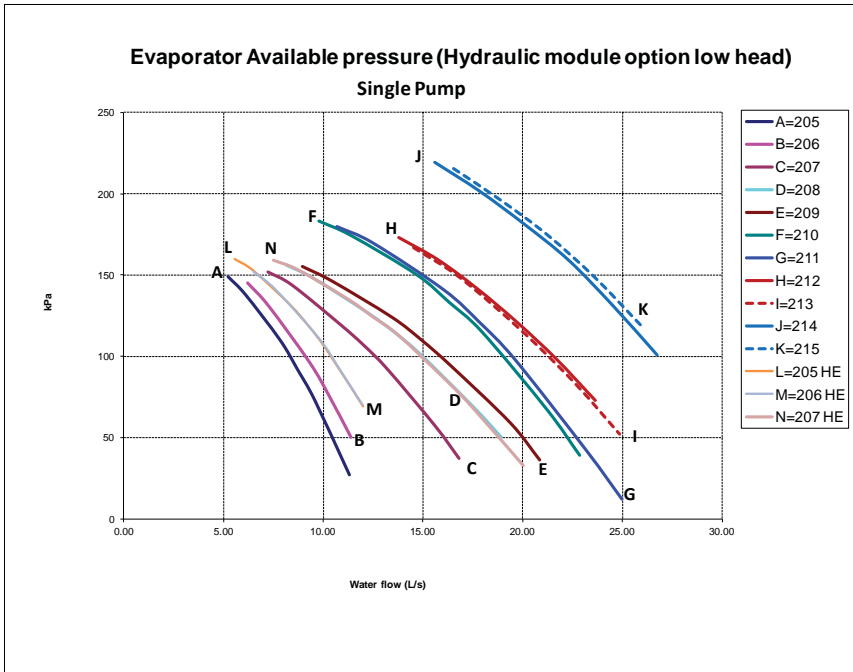

EWFR : Evaporator Waterflow Rate

EWPD : Evaporator Water Pressure Drop

Figure 7 – Chiller available pressure - Evaporator side - Standard and High Efficiency units - Low head pressure - Dual pump

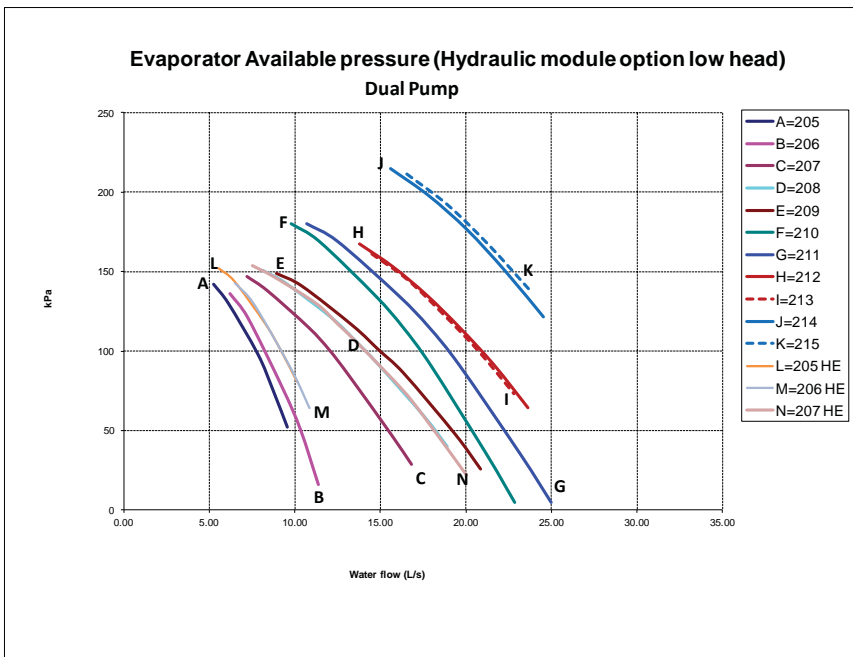

EWFR : Evaporator Waterflow Rate

EWPD : Evaporator Water Pressure Drop

Hydraulic data

Figure 8 – Chiller available pressure - evaporator side - Standard and High Efficiency units - High head pressure - Single pump

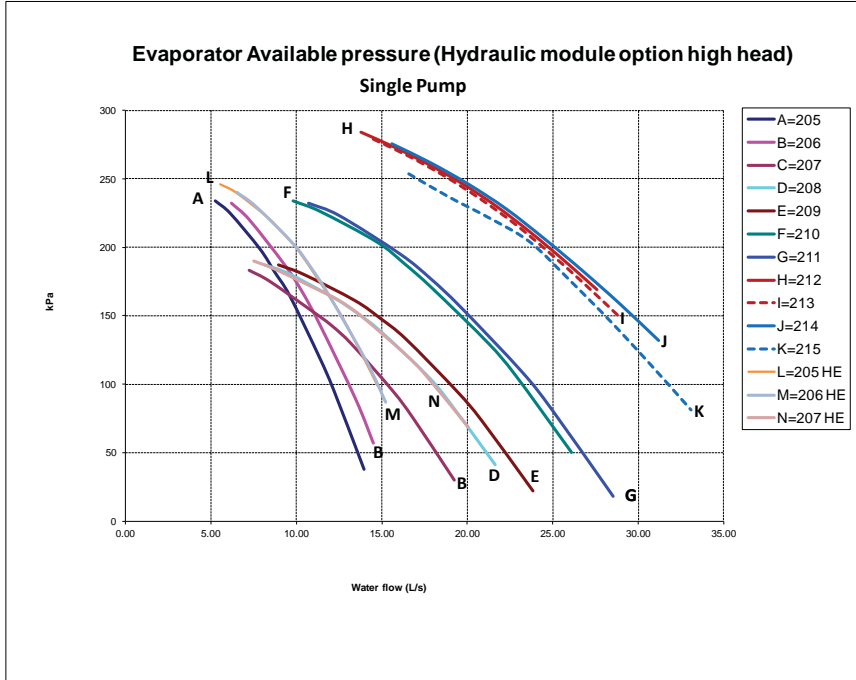

EWFR : Evaporator Waterflow Rate

EWPD : Evaporator Water Pressure Drop

Figure 9 – Chiller available pressure - evaporator side - Standard and High Efficiency units - High head pressure - Dual pump

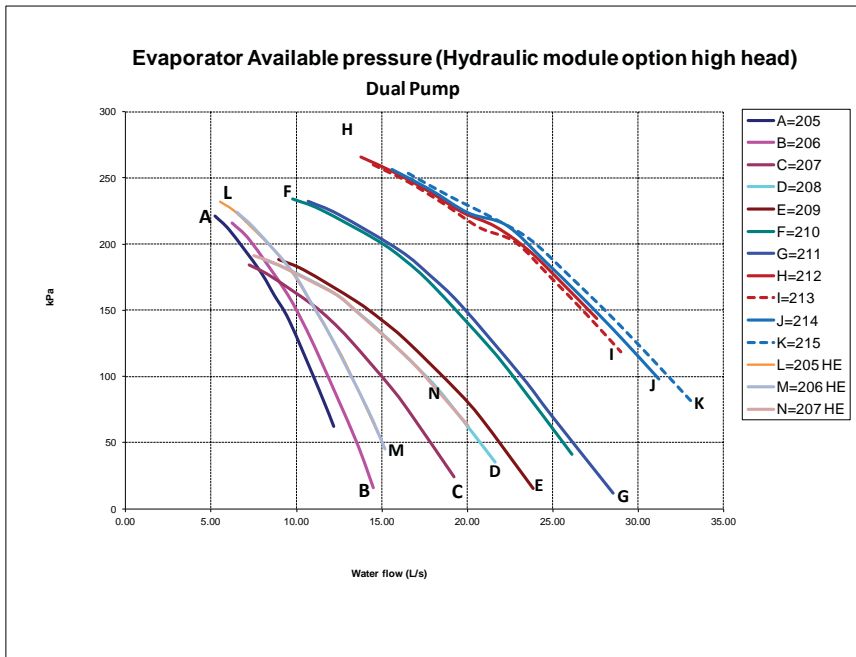

EWFR : Evaporator Waterflow Rate

EWPD : Evaporator Water Pressure Drop

Hydraulic data

Figure 10 – Chiller available pressure - condenser side - Standard and High Efficiency units - Low head pressure

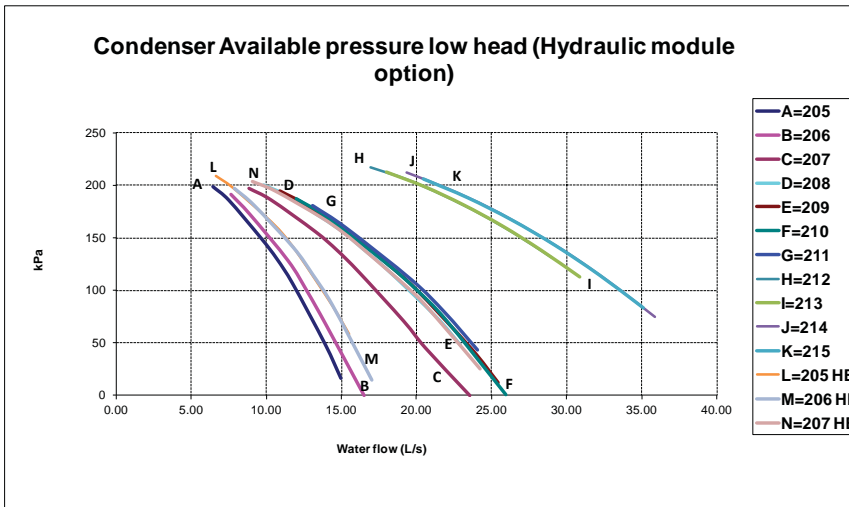

CWFR : Condenser Waterflow Rate

CWPD : Condenser Water Pressure Drop

Note: Pumps remain the same when variable speed drive option is selected.

Figure 11 – Chiller available pressure - condenser side - Standard and High Efficiency units - High head pressure

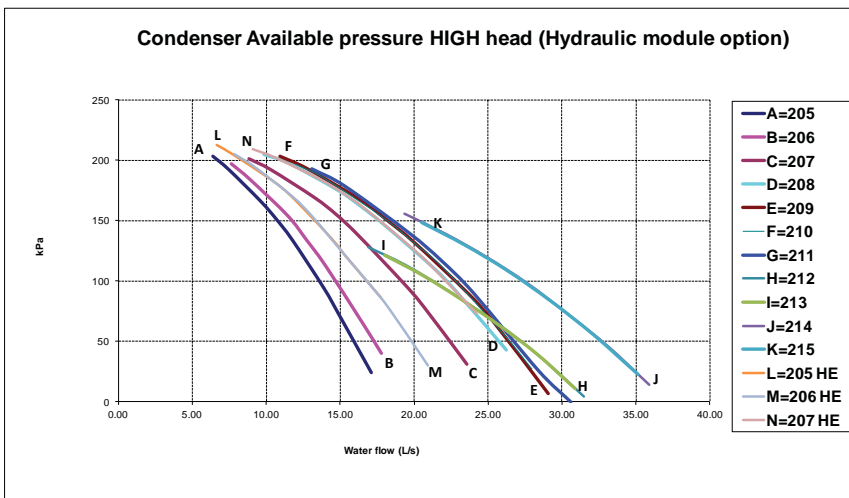

CWFR : Condenser Waterflow Rate

CWPD : Condenser Water Pressure Drop

Note: Pumps remain the same when variable speed drive option is selected.

Sound performances

Table 11 – Sound Power Level - standard and high efficiency units without compressor sound jacket

Size	Sound Power Level Lw (d(B))								Global dB(A)
	63 Hz	125 Hz	250 Hz	500 Hz	1 kHz	2 kHz	4 kHz	8 kHz	
205	93 dB	75 dB	76 dB	84 dB	71 dB	69 dB	65 dB	64 dB	82 dBA
206	92 dB	75 dB	76 dB	82 dB	75 dB	71 dB	67 dB	65 dB	82 dBA
207	92 dB	75 dB	76 dB	84 dB	76 dB	73 dB	68 dB	64 dB	83 dBA
208	91 dB	73 dB	76 dB	83 dB	78 dB	74 dB	69 dB	65 dB	83 dBA
209	91 dB	74 dB	77 dB	84 dB	79 dB	75 dB	70 dB	65 dB	84 dBA
210	91 dB	80 dB	81 dB	84 dB	78 dB	73 dB	67 dB	61 dB	84 dBA
211	91 dB	80 dB	80 dB	84 dB	80 dB	74 dB	69 dB	64 dB	84 dBA
212	94 dB	84 dB	89 dB	84 dB	79 dB	80 dB	71 dB	64 dB	87 dBA
213	95 dB	87 dB	88 dB	85 dB	81 dB	81 dB	73 dB	66 dB	88 dBA
214	84 dB	87 dB	88 dB	84 dB	83 dB	81 dB	74 dB	67 dB	88 dBA
215	95 dB	89 dB	88 dB	86 dB	85 dB	83 dB	76 dB	69 dB	90 dBA

* High efficiency not available for sizes 212 to 215

Table 12 – Sound Power Level - standard and high efficiency units with compressor sound jacket

Size	Sound Power Level Lw (d(B))								Global dB(A)
	63 Hz	125 Hz	250 Hz	500 Hz	1 kHz	2 kHz	4 kHz	8 kHz	
205	92 dB	74 dB	75 dB	81 dB	67 dB	62 dB	60 dB	55 dB	79 dBA
206	91 dB	74 dB	74 dB	80 dB	71 dB	65 dB	61 dB	56 dB	79 dBA
207	91 dB	74 dB	76 dB	82 dB	72 dB	66 dB	63 dB	56 dB	80 dBA
208	90 dB	73 dB	75 dB	81 dB	74 dB	68 dB	64 dB	57 dB	80 dBA
209	90 dB	73 dB	76 dB	81 dB	74 dB	69 dB	64 dB	57 dB	81 dBA
210	93 dB	79 dB	80 dB	82 dB	75 dB	67 dB	64 dB	58 dB	81 dBA
211	93 dB	79 dB	79 dB	81 dB	76 dB	69 dB	64 dB	62 dB	81 dBA
212	91 dB	85 dB	89 dB	83 dB	74 dB	75 dB	66 dB	55 dB	84 dBA
213	91 dB	85 dB	89 dB	83 dB	77 dB	77 dB	68 dB	57 dB	85 dBA
214	91 dB	85 dB	88 dB	83 dB	77 dB	78 dB	70 dB	59 dB	85 dBA
215	92 dB	87 dB	88 dB	84 dB	81 dB	78 dB	71 dB	60 dB	87 dBA

* High efficiency not available for sizes 212 to 215

The sound power levels above are valid for:

- CGWN water cooled chillers operating at a condenser leaving water temperature below or equal to 40°C
- CCUN condenserless chillers operating at a saturated condensing temperature below or equal to 45°C

Should the units operate at different conditions, apply correction factors to global sound pressure as described in the table below.

Table 13 – Correction factors for other conditions

		Without compressor sound jacket	With compressor sound jacket
CGWN	Condenser leaving water temperature	40 to 50 °C	- 1 dB(A)
		50 to 58 °C	- 2 dB(A)
CCUN	Saturated condensing temperature	45 to 55 °C	- 1 dB(A)
		55 to 63 °C	- 2 dB(A)

Typical unit schematics

Figure 12 – CGWN refrigerant flow chart (205-211)

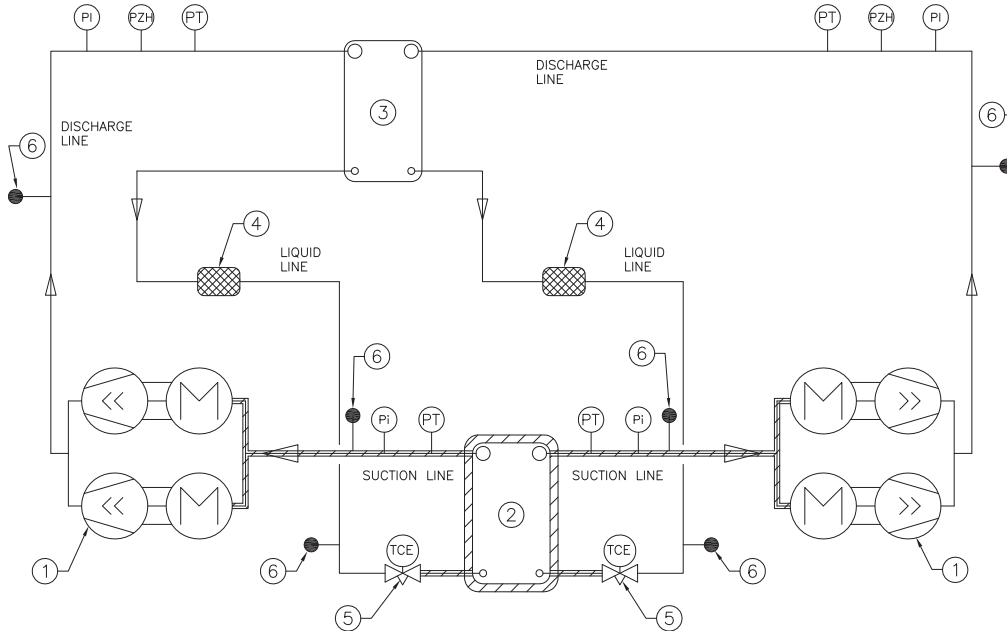
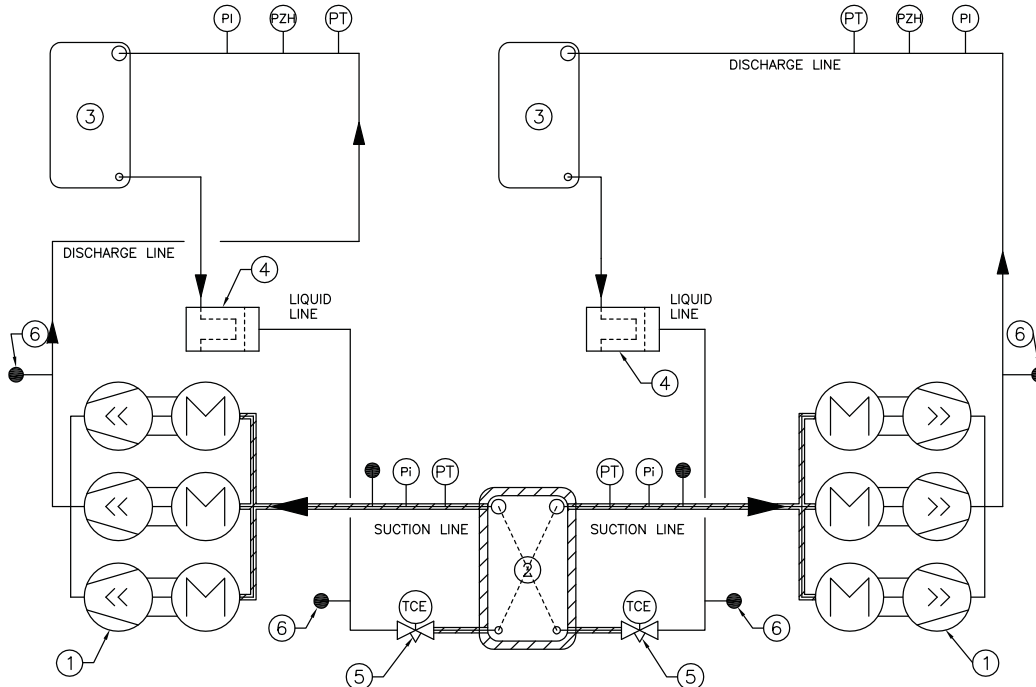

Figure 13 – CGWN refrigerant flow chart (212-215)



- | | |
|----------------------------|---------------------------|
| 1: Scroll compressor | 7: Discharge line |
| 2: Brazed plate evaporator | 8: Liquid Line |
| 3: Brazed plate condenser | 9: Suction Line |
| 4: Filter drier | Pi: Gauge |
| 5: Expansion valve | PT: Pressure transducer |
| 6: ¼ SAE Male pressure tab | PZH: High pressure switch |

Typical unit schematics

Figure 14 – CCUN refrigerant flow chart (205-211)

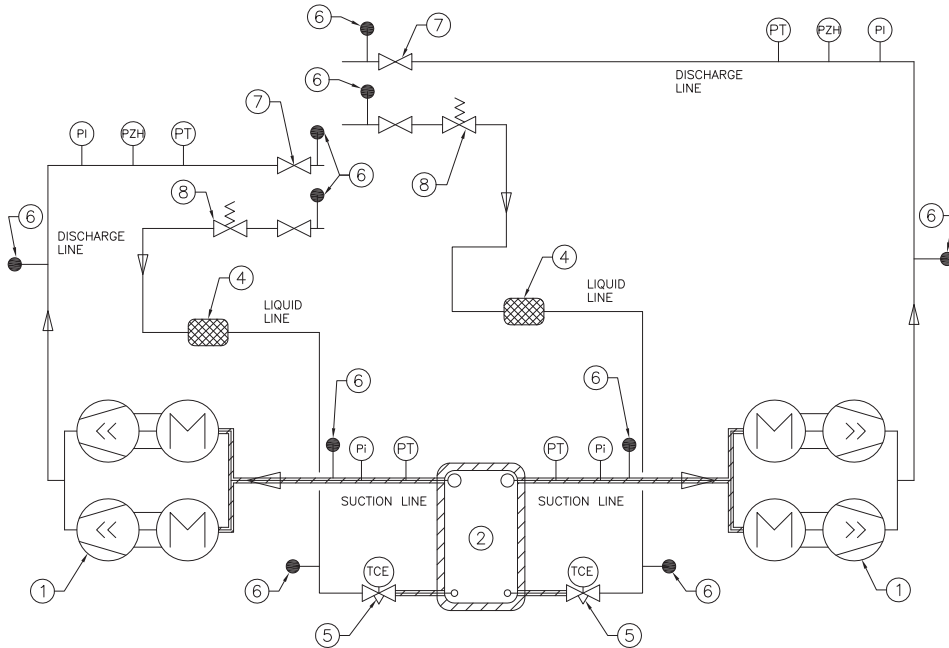
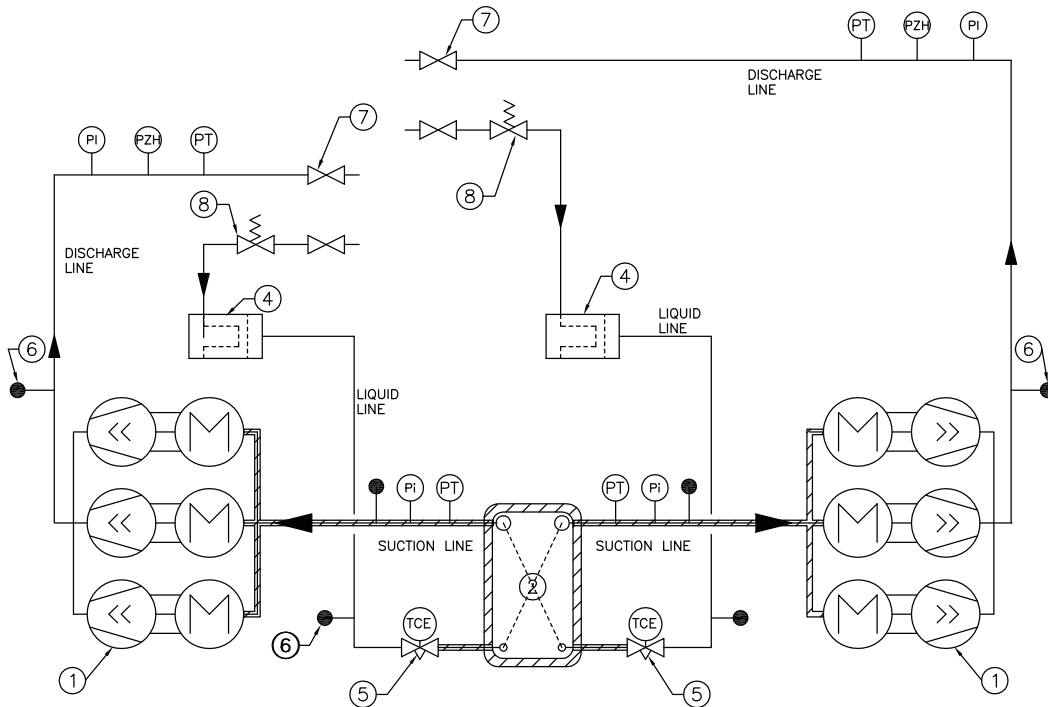

Figure 15 – CCUN refrigerant flow chart (212-215)



- 1: Scroll compressor
- 2: Brazed plate evaporator
- 4: Filter drier
- 5: Expansion valve
- 6: ¼ SAE Male pressure tab
- 7: Discharge line

- 8: Liquid Line
- 9: Suction Line
- 10: Service valve
- 11: Solenoid valve
- Pi: Gauge
- PT: Pressure transducer
- PZH: High pressure switch

Typical unit schematics

Figure 16 – CGWN hydraulic flow chart – without hydraulic module (205-211)

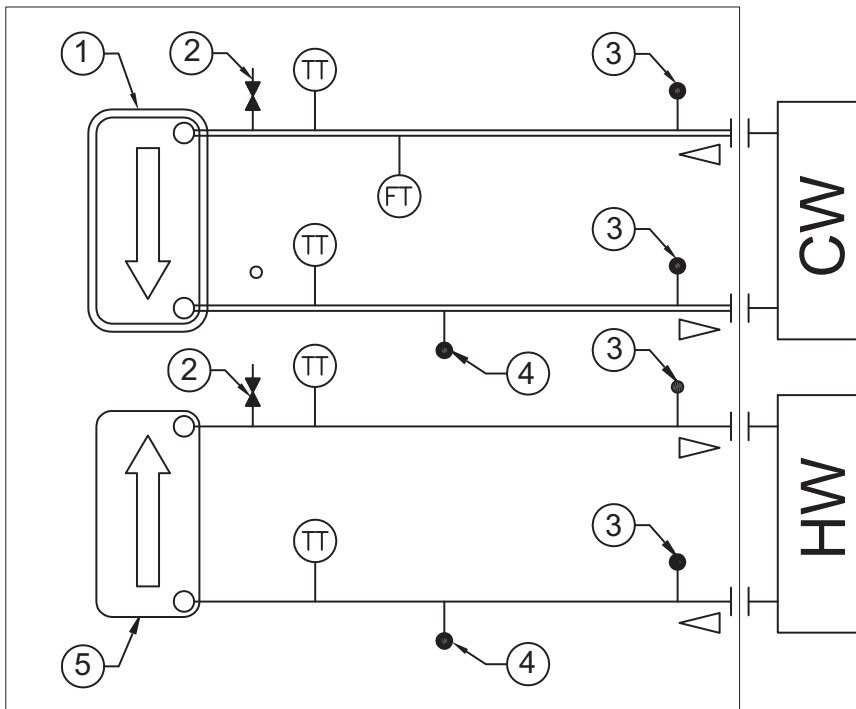
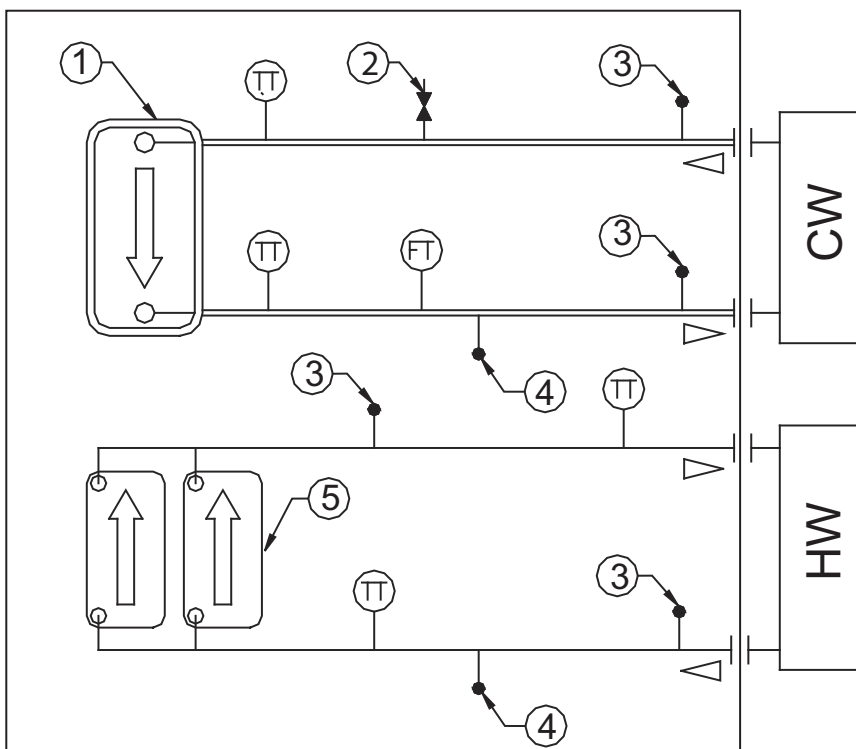

Figure 17 – CGWN hydraulic flow chart – without hydraulic module (212-215)



- 1: Insulated evaporator
- 2: Valve for air vent
- 3: ¼ SAE Male pressure tab
- 4: ¼ SAE Male drain tab
- 5: Condenser

- CW: Chilled water loop
- HW: Condensation water loop
- TT: Temperature sensor
- FT: Water flow switch

Typical unit schematics

Figure 18 – CCUN hydraulic flow chart – without hydraulic module (205-211)

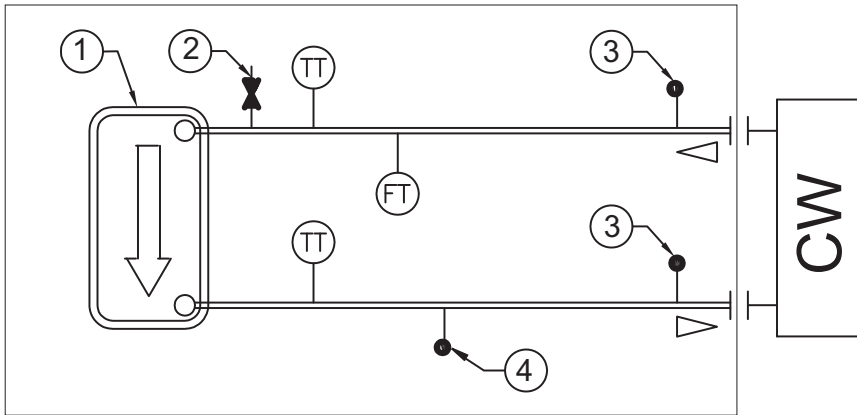
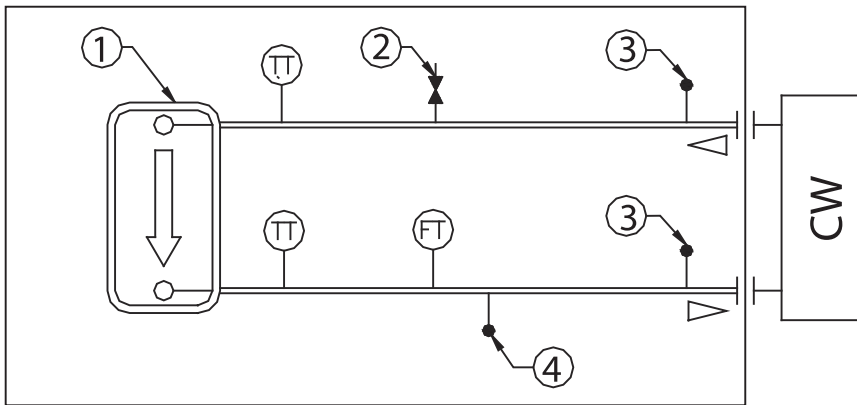

Figure 19 – CCUN hydraulic flow chart – without hydraulic module (212-215)



- 1: Insulated evaporator
- 2: Valve for air vent
- 3: ¼ SAE Male pressure tab
- 4: ¼ SAE Male drain tab
- 5: Condenser

- CW: Chilled water loop
- HW: Condensation water loop
- TT: Temperature sensor
- FT: Water flow switch

Typical unit schematics

Figure 20 – CGWN hydraulic flow chart – with hydraulic module (205-211)

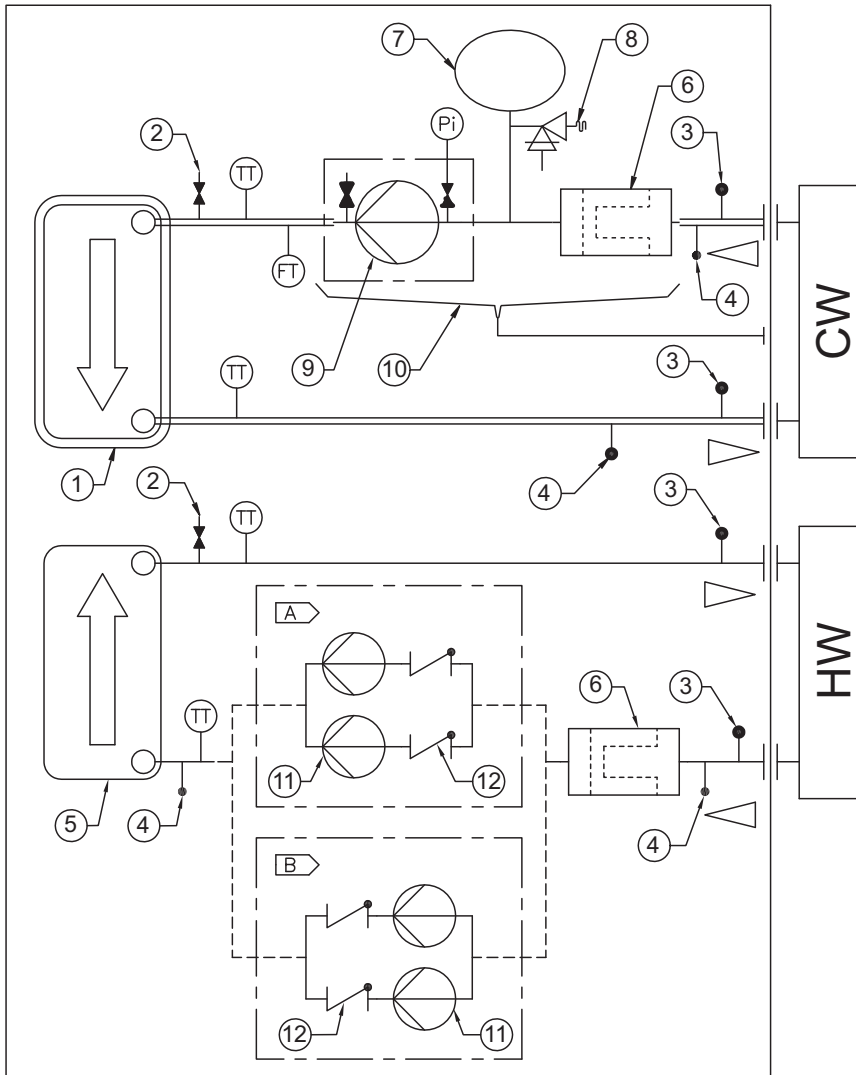

1: Insulated evaporator

2: Valve for air vent

3: ¼ SAE Male pressure tab

4: ¼ SAE Male drain tab

5: Condenser

6: Water strainer

7: Expansion Tank

8: Pressure relief valve

9: Single or double evaporator pump

10: Drain pan

11: Condenser pump

12: Check valve

CW: Chilled water loop

HW: Condensation water loop

TT: Temperature sensor

Pi: Pressure gauge

FT: Water flow switch

A: For sizes 205 to 207 standard head 3"

B: For sizes 208 to 211

and all sizes high 4"

Typical unit schematics

Figure 21 – CGWN hydraulic flow chart – with hydraulic module (212-215)

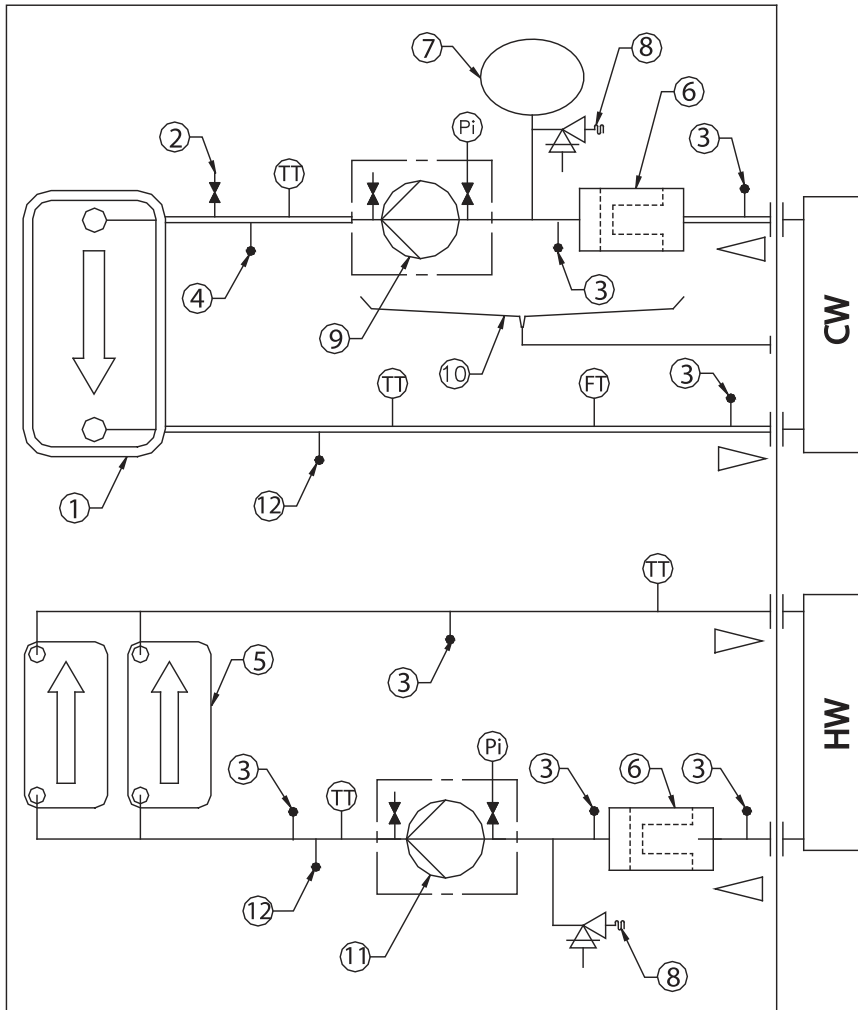

- 1: Insulated evaporator
- 2: Valve for air vent
- 3: ¼ SAE Male pressure tab
- 4: ¼ SAE Male drain tab
- 5: Condenser
- 6: Water strainer
- 7: Expansion Tank
- 8: Pressure relief valve
- 9: Single or double evaporator pump
- 10: Drain pan
- 11: Condenser pump
- 12: ¼ NPT drain tab

- CW: Chilled water loop
- HW: Condensation water loop
- TT: Temperature sensor
- Pi: Pressure gauge
- FT: Water flow switch

Typical unit schematics

Figure 22 – CCUN hydraulic flow chart – with hydraulic module (205-211)

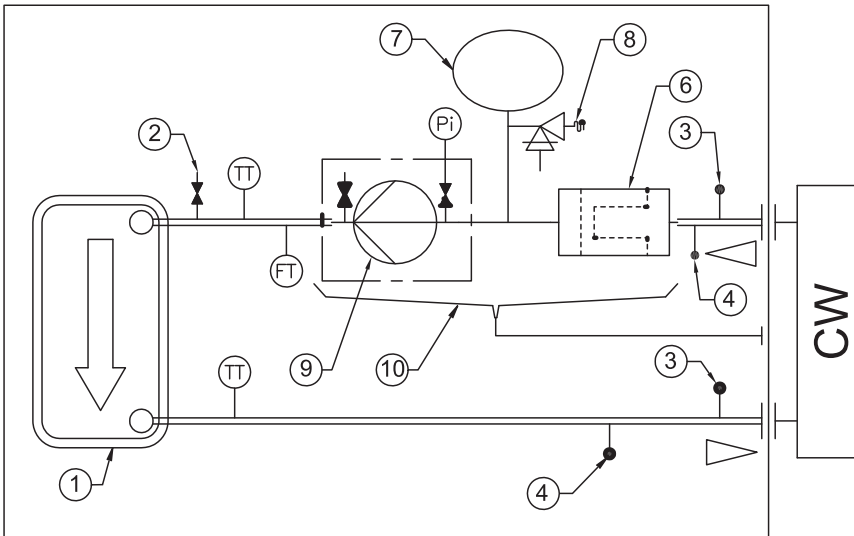
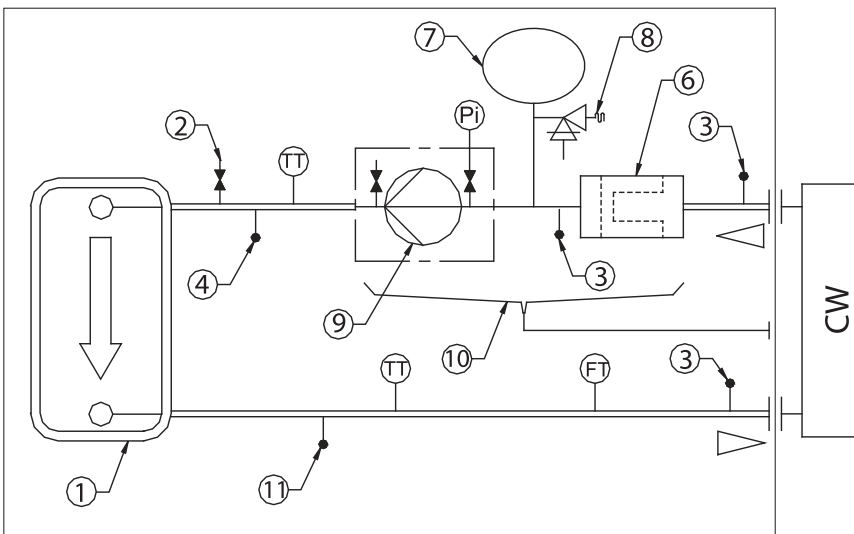

Figure 23 – CCUN hydraulic flow chart – with hydraulic module (212-215)



1: Insulated evaporator

2: Valve for air vent

3: ¼ SAE Male pressure tab

4: ¼ SAE Male drain tab

6: Water strainer

7: Expansion Tank

8: Pressure relief valve

9: Single or double evaporator pump

10: Drain pan

11: ¼ NPT drain tab

CW: Chilled water loop

TT: Temperature sensor

Pi: Pressure gauge



Trane optimizes the performance of homes and buildings around the world. A business of Ingersoll Rand, the leader in creating and sustaining safe, comfortable and energy efficient environments, Trane offers a broad portfolio of advanced controls and HVAC systems, comprehensive building services and parts. For more information visit www.Trane.com

Trane has a policy of continuous product and product data improvement and reserves the right to change design and specifications without notice.

© 2016 Trane All rights reserved
CG-PRC014G-GB September 2016
Supersedes CG-PRC014F-GB_0616

We are committed to using environmentally
conscious print practices that reduce waste.

