



# XStream™ Water-cooled screw chillers and Water/Water Heat pumps

Refrigerant R134a - R513A

Model RTWF SE, HE, HSE 100 - 515 (370 to 1860 kW)

Model RTHF XE, HSE 330 - K00 (1140 to 3670 kW)

Model RTHF XSE 855 - 995 (2970 to 3635 kW)



April 2020

RLC-PRC058F-GB

TRANE  
TECHNOLOGIES



# Table of Contents

Introduction.....	3
Features and benefits .....	4
Trane Helical-Rotary Compressors .....	4
Capacity Control and Load Matching.....	4
Base unit description.....	8
Options description .....	9
General Data .....	11
Heating Performance.....	24
Operating Maps .....	26
Evaporator pressure drop.....	27
Pressure drop.....	27
Condenser pressure drop .....	30
Electrical Data .....	33
Acoustic Data .....	35
Notes.....	37

# Introduction

The new **Trane XStream™** series is the result of a search for higher reliability and higher energy efficiency, for today's environment.

In an effort to reduce energy consumed by cooling and heating equipment and to continually operate, Trane has developed the **XStream** series chillers and heat pumps with higher efficiencies and a more reliable design than any other water-to-water equipment available on the market today.

The **XStream** series uses the proven design of the Trane helical-rotary compressors, which embraces all of the design features that have made the Trane helical-rotary compressor liquid chillers such a success since 1987.

The industrial-grade design of this helical rotary chillers and heat pumps is ideal for both industrial and commercial markets, in applications such as office buildings, hospitals, schools, retail buildings, and industrial facilities.

The major advantages of the **XStream** series are:

- Extended and unmatched capacities
- High efficiencies both in cooling and heating
- 99.5% reliability rate
- Suitable with high condensing temperature and heat pump applications with possible delivery of hot water up to 68°C (RTWF)
- Great versatility to adapt to varying applications requirements

**XStream** series come in several versions and efficiency levels, to allow customers to make the best choice according to his main criteria, whether they are economical or environmental.

**RTWF** offers 3 efficiency levels

- Standard Efficiency (SE),
- High Efficiency (HE),
- High Seasonal Efficiency (HSE), featuring Trane Adaptive Frequency Drive (AFD)

**RTHF** offers 3 efficiency levels

- Extra Efficiency (XE)
- High Seasonal Efficiency (HSE), featuring Trane Adaptive Frequency Drive (AFD)
- Extra High Seasonal Efficiency (XSE) featuring Variable Volume Index compressor and Adaptive Frequency Drive (AFD) Speed to reach the highest part load efficiencies (SEER)



**RTWF**



**RTHF**



**RTWF**

# Features and benefits

## Trane Helical-Rotary Compressors

- **Unequaled-reliability.** Trane helical-rotary compressor are designed, built, and tested to the same demanding and rugged standards as the previous generation helical-rotary compressors used in both air- and water-cooled chillers for more than 27 years.
- **Years of research and testing.** The Trane helical-rotary compressors have amassed thousands of hours of testing, much of it at severe operating conditions beyond normal commercial air- conditioning applications.
- **Proven track record.** The Trane Company is the world's largest manufacturer of large helical- rotary compressors used for refrigeration. Over 400 000 compressors worldwide have proven that the Trane helical- rotary compressors have a reliability rate of greater than 99.5% in the first year of operation — unequalled in the industry.
- **Resistance to liquid slugging.** The robust design of the Trane Series R™ compressor can ingest amounts of liquid refrigerant that normally would severely damage compressor.
- **Fewer moving parts.** The helical- rotary compressor has only two rotating parts: the male rotor and the female rotor.
- **Direct-drive, low-speed,** semi- hermetic compressor for high efficiency and high reliability.
- **Field-serviceable compressor** for easy maintenance.
- **Suction-gas-cooled motor.** The motor operates at lower temperatures for longer motor life.
- **Five minute** start-to-start and two minute stop-to-start anti-recycle timer allows for closer water-loop temperature control.

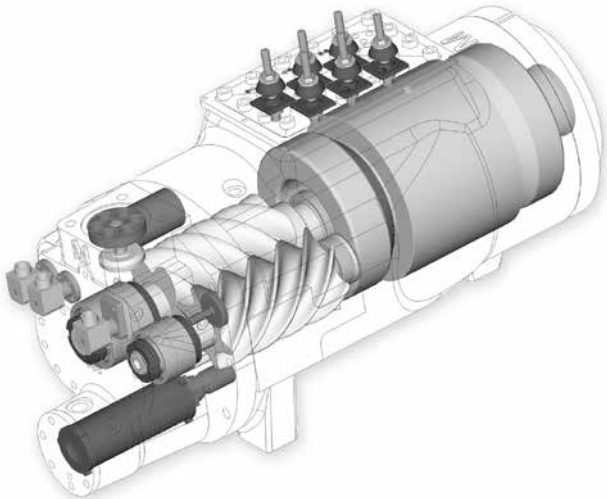

*Trane GP2 compressor*

## Capacity Control and Load Matching

The combination patented unloading system on Trane helical- rotary compressors uses the variable unloading valve for the majority of the unloading function. This allows the compressor to modulate infinitely, to exactly match building load and to maintain chilled-water supply temperatures within  $\pm 0.3^{\circ}\text{C}$  of the set point. Helical- rotary chillers that rely on stepped capacity control must run at a capacity equal to or greater than the load, and typically can only maintain water temperature to around  $\pm 1^{\circ}\text{C}$ . Much of this excess capacity is lost because overcooling goes toward removing building latent heat, causing the building to be dried beyond normal comfort requirements.

On RTWF and RTHF HSE version, the combination of the variable unloading valve plus the Adaptive Frequency™ drive allows exactly matching building load and getting excellent efficiencies at full load and part load.

HSE units (AFD equipped) are fully compliant with Class C3 (Industrial environment) requirements of EN61800-3 standard.

On RTHF XSE version, operating pressure ratio is managed thanks to a dispositive adapting Compressor Volume Index in order to deliver the best pressure ratio. Capacity control is managed exclusively through the Adaptive Frequency Drive (AFD).

## Features and benefits

### CHIL evaporator

Trane developed an evaporator specially designed for **XStream** chillers. Compact - High performance - Integrated design - Low charge (CHIL) evaporator optimizes the flow of the refrigerant to get an excellent heat exchange with water in every operating condition and minimize the quantity of refrigerant used.

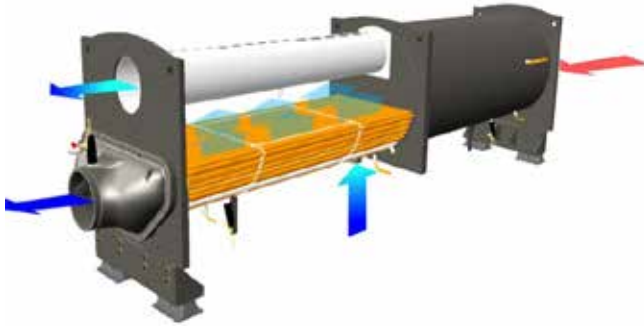

### High Lift applications

When considering heat pump or low leaving temperatures industrial process applications, compressor operates under severe pressure conditions, which, if not anticipated may be harmful for compressor or considerably decrease life and reliability of compressor. For high lift applications, **XStream** RTWF units, feature a dedicated compressor design to keep up with those harsh operating conditions. Therefore, RTWF units can reach temperatures as low as  $-12^{\circ}\text{C}$  on the evaporator side or as high as  $68^{\circ}\text{C}$  on the condensing side, yet keeping high efficiency and premier reliability.

### Variable Primary Flow

An attractive chilled-water system option may be a variable primary flow (VPF) system. VPF systems present building owners with several cost-saving benefits that are directly related to the pumps. The most obvious cost savings result from eliminating the secondary distribution pump, which in turn avoids the expense incurred with the associated piping connections (material, labor), electrical service, and variable-frequency drive.

Building owners often cite pump related energy savings as the reason that prompted them to install a VPF system. With the help of a TRANE software analysis tool, you can determine whether the anticipated energy savings justify the use of variable primary flow in a particular application. It may also be easier to apply variable primary flow in an existing chilled-water plant.

Unlike the “decoupled” design, the bypass can be positioned at various points in the chilled-water loop and an additional pump is unnecessary. The evaporator in the **XStream** series can withstand up to 50% percent water flow reduction as long as this flow is equal to or above the minimum flow-rate requirements. The microprocessor and capacity control algorithms are designed to handle a maximum of 10% change in water flow rate per minute in order to maintain  $\pm 0.3^{\circ}\text{C}$  leaving evaporator temperature control. For applications in which system energy savings is most important and tight temperature control is classified as  $\pm 1.1^{\circ}\text{C}$ , up to 30% changes in flow per minute are possible.

### Factory Testing Means Trouble-Free Start-up

All **XStream** chillers are given a complete functional test at the factory. This computer-based test program completely checks the sensors, wiring, electrical components, microprocessor function, communication capability, expansion valve performance, and fans. In addition, each compressor is run-tested to verify capacity and efficiency. Where applicable, each unit is factory preset to the customer’s design conditions. An example would be the leaving-liquid temperature set point. The result of this test program is that the chiller arrives at the job site fully tested and ready for operation.

### Factory-Installed and Tested Controls and Options Speed Installation

All **XStream** chiller options are factory installed and tested. Some manufacturers send accessories in pieces to be field installed. With Trane, the customer saves on installation expense and has assurance that ALL chiller controls and options have been tested and will function as expected.



## Features and benefits

### Superior Control with UC 800™ Chiller controls

The Adaptive Control™ microprocessor system enhances the **XStream** chiller by providing the very latest chiller control technology. With the Adaptive Control microprocessor, unnecessary service calls and unhappy tenants are avoided. The unit does not nuisance-trip or unnecessarily shut down. Only when the chiller controls have exhausted all possible corrective actions and the unit is still violating an operating limit, will the chiller shut down. Controls on other equipment typically shut down the chiller, usually just when it is needed the most.



### SmartFlow control

XStream series units are fully compatible with variable flow operation both on evaporator and condenser sides. The modulation of the pump speed is managed to ensure that chiller  $\Delta T$  stays constant. Entering and leaving temperatures at the evaporator will be measured directly by the chiller controller, through the factory-supplied sensor. A  $\Delta T$  setpoint will be present on the unit controller. The option for constant  $\Delta T$  is intended to be used with 3-way valves on water systems, or 2-way valves on water system but constant flow at the by-pass.

### System option: Ice storage

**UC 800** optimization software controls operation of the required equipment and accessories to easily move from one mode of operation to another. For example: even with ice-storage systems, there are numerous hours when ice is neither produced nor consumed, but saved.

In this mode, the chiller is the sole source of cooling. For example, to cool the building after all ice is produced but before high electrical demand charges take effect, UC 800 sets the chiller leaving- fluid set point to its most efficient setting and starts the chiller, chiller pump, and load pump.

When electrical demand is high, the ice pump is started and the chiller is either demand limited or shut down completely. UC 800 controls have the intelligence to optimally balance the contribution of the ice and the chiller in meeting the cooling load.

The capacity of the chiller plant is extended by operating the chiller and ice in tandem. UC 800 rations the ice, augmenting chiller capacity while reducing cooling costs. When ice is produced, UC 800 will lower the chiller leaving-fluid set point and start the chiller, ice and chiller pumps, and other accessories. Any incidental loads that persist while producing ice can be addressed by starting the load pump and drawing spent cooling fluid from the ice storage tanks.

For specific information on ice storage applications, contact your local sales office.

## Features and benefits

### Series counterflow chiller configuration

When considering multiple chillers plant, designers conventionally go for parallel-piped chillers configuration. Nevertheless, there are ways to bring more efficiency by using a different chiller lay-out.

An effective alternative to consider is to pipe the chillers in series. Larger  $\Delta T$  and low flow design save energy on the pumping. Series chiller configuration allows as well, to get a better efficiency from the upstream chiller, more lightly loaded. Combining this configuration with Variable Primary Flow (VPF) will further increase system efficiency.

Series piping principle can also be applied to condenser side. This is called Series-Series counterflow configuration. This will result in similar advantages on the condenser side, enlarging the opportunity for savings on the overall system.

For more information on Series chillers arrangements, refer to Trane Application Engineering Manual about Multiple-Chiller system design and control (SYS-AP M001).



### Product certification

Trane as a Global leader in the HVAC industry participates to both Eurovent and AHRI chillers certification programs. Through this third party certifications, Trane commits to deliver units that comply with the declared performance.



# Base unit description

	RTWF 100 to 250			RTWF 275 to 515			RTHF 330 to K00		
	SE	HE	HSE	SE	HE	HSE	XE	HSE	XSE
<b>Power Supply</b>	400 V - 3 Ph - 50 Hz - Single point								
<b>Compressor Type</b>	Trane CHHP/CHHW						Trane CHHC	Trane CHHC (VVi)	
<b>Compressor Technology</b>	Fixed Speed		AFD	Fixed Speed		AFD	Fixed Speed	AFD	AFD
<b>Number of circuits</b>	1			2					
<b>Compliance</b>	CE - PED								
<b>Condenser application</b>	Cooling: Leaving Condenser Water Temp ≤ 50°C Heating: Low temp Water to Water HP operation						Cooling: Leaving Condenser Water Temp ≤ 50°C	Cooling: Leaving Condenser Water Temp ≤ 48°C	
<b>Evaporator application</b>	Cooling : Leaving Evaporator Water Temp ≥ 4.4°C						Cooling : Leaving Evaporator Water Temp ≥ 4.4°C	Cooling: Leaving Condenser Water Temp >= 4.4°C	
<b>Refrigerant</b>	R134a - R513A			R134a			R134a		
<b>Relief Valve</b>	Single relief valve on condenser								
<b>Evaporator water connections</b>	Direct Connection - Grooved pipes								
<b>Evaporator water side pressure</b>	10 bar								
<b>Condenser water connections</b>	Direct Connection - Grooved pipes								
<b>Condenser water side pressure</b>	10 bar								
<b>Flow control</b>	Constant Flow - Pump signal On/Off (Condenser + Evaporator)								
<b>Power protection</b>	Fused								
<b>Electrical IP protection</b>	Enclosure with Dead Front protection								
<b>Installation accessories</b>	Optional								



# Options description

Option Description	Application	Available for		
		RTWF	RTHF	
400 V - 3 Ph - 50 Hz - Dual point	2 distinct power supplies, one per circuit	Renovation. Replacement of two smaller units by one only.	-	●
<b>Condenser Application</b>				
High Temp Condenser	Compressor design optimized for high compression ratio	Dry cooler applications with up to 68°C Condenser leaving water	●	-
Med & High temp water to water HP operation	Compressor design optimized for high compression ratio + Condenser leaving water temperature control	Heat pump applications with Leaving water up to 68°C	●	-
Low temp water to water heat pump operation	Condenser Leaving water temperature control	Heat pump applications with condenser entering water temperature up to 68°C	●	-
2 pass condenser	Additional pass on condenser side	Condenser application with Delta T > 7K (RTWF HE and RTWF HSE)	●*	-
<b>Evaporator Application</b>				
Process Cooling - Leaving Evaporator Water Temp < 4.4°C	Compressor design optimized for high compression ratio	Process cooling applications down to -12°C leaving water	●	●
Ice making	Compressor design optimized for high compression ratio + Dual setpoint (Comfort / Ice making)	Ice storage applications for Ice making temps as low as -7°C	●	●
Sound Attenuation Package	Additional compressor sound enclosure	Sound reduction of 3 dB(A) per Compressor	●	-
<b>Relief Valve</b>				
Single relief Valve on both condenser and evaporator	Additional relief valve on Low pressure side	Additional pressure safety device	●	●
Dual Relief valve on condenser only	2 relief valve with by 3 way valve on high pressure side	Maintenance	●	●
Dual relief Valve on both evaporator and condenser	2 relief valve with by 3 way valve on both high and low side	Maintenance	●	●
<b>Evaporator water connection</b>				
Left hand Connection	RTWF 100 to 250: Location of water boxes on the left side of the unit (facing control panel) RTWF 275 to 515 and RTHF: Additional pipe allowing connections on the left side of the unit (facing control panel)	Supply and return water on the same side of the unit	●	●
Right hand Connection	RTWF 100 to 250: Location of water boxes on the right side of the unit (facing control panel) RTWF 275 to 515 and RTHF: Additional pipe allowing connections on the right side of the unit (facing control panel)	Supply and return water on the same side of the unit	●	●
No insulation on cold parts	Unit delivered without insulation on Evaporator and cold parts	For field supplied insulation by customer	●	●
<b>Condenser water connection</b>				
Left hand Connection	RTWF 100 to 250: Location of water boxes on the left side of the unit (facing control panel) RTWF 275 to 515 and RTHF: Additional pipe allowing connections on the left side of the unit (facing control panel)	Supply and return water on the same side of the unit	●	●
Right hand Connection	RTWF 100 to 250: Location of water boxes on the right side of the unit (facing control panel) RTWF 275 to 515 and RTHF: Additional pipe allowing connections on the right side of the unit (facing control panel)	Supply and return water on the same side of the unit	●	●
Condenser thermal insulation	Thermal insulation of condenser	Heat Pump application to avoid wasted heat	●	●

● Factory mounted ▲ Accessory (not fitted) - Not proposed

\* Only for RTWF 275 to 515

## Options description

Option Description	Application	Available for		
		RTWF	RTHF	
<b>SmartFlow Control</b>				
VPF Constant Delta T Evaporator	Optional PC board delivering a 2-10 V modulating signal output to control a pump motor speed inverter	Evaporator variable speed pump control based on a constant Delta T	●	●
VPF Constant Delta T Condenser	Optional PC board delivering a 2-10 V modulating signal output to control a pump motor speed inverter	Condenser variable speed pump control based on a constant Delta T	●	●
VPF Constant Delta T Evaporator and Condenser	Optional PC board delivering a 2-10 V modulating signal output to control a pump motor speed inverter	Evaporator and Condenser variable speed pump control based on constant Delta T's	●	●
Power protection	Unit protection by Circuit Breaker	Protection of compressors against over current	●	●
<b>Under/over voltage protection</b>				
Under/Over voltage protection	Phase monitoring device	Protection of unit against voltage unbalance (Standard feature on HSE variable speed units)	●	●
Under/Over voltage protection + ground fault protection	Phase monitoring device + differential circuit breaker	Protection of unit against voltage unbalance and ground fault	●	●
<b>Smart Com protocole</b>				
BACNet MSTP interface	Communication card	Communication with BMS through BACNet MSTP Protocol	●	●
BACNet IP interface	Communication card	Communication with BMS through BACNet IP Protocol	●	●
ModBus RTU interface	Communication card	Communication with BMS through Modbus Protocol	●	●
LonTalk Interface	Communication card	Communication with BMS through LonTalk Protocol	●	●
External setpoints & capacity outputs	Programmable Input/Output card and sensors	Remote Control or remote monitoring	▲	▲
Outdoor Air Temp Sensor	With Outdoor Air Temp Sensor	Measurement of Outdoor ambient air temp to perform water set point offset	▲	▲
Electrical IP Protection	IP 20 protection	Electrical safety	●	●
Master slave operation	Communication card	Operation of two chillers on a same water loop	●	●
Energy metering	Additional energy meter	Monitors electricity consumption (kWh) of the full unit	●	●
<b>Condenser Refrigerant Pressure Output</b>				
Condenser Water Control Output	Communication card - 0-10 V Analog output	Allows to control a valve on condenser loop to perform proper unit start when condenser water loop is cold	●	●
Condenser Pressure (%HPC) Output	Communication card - 0-10 V Analog output	Allows control of cooling device based on condenser pressure (Ie. Cooling tower fan, 3-Way valve....)	●	●
Differential Pressure Output	Communication card - 0-10 V Analog output	Allows control of a 3-way valve on condenser water loop	●	●
Power socket	230 V Power socket	Local Power source to connect an electrical device such as a Laptop	●	●
<b>Anti vibration accessories</b>				
Neoprene isolators		Eliminates vibration transmission risk to building	▲	▲
Neoprene pads		Eliminates vibration transmission risk to building	▲	▲
Grooved pipe with coupling & pipe stub	4 Grooved pipe adapters	Allows welded connection to unit	▲	▲
<b>Flow Switch</b>				
Evap or Condenser Flow switch	One Flow Switch delivered to be installed either on Evaporator or Condenser side	Allows to check flow detection	▲	▲
Evap and Condenser Flow switch	Two Flow Switches delivered to be installed respectively on Evaporator and Condenser side	Allows to check flow detection	▲	▲

● Factory mounted ▲ Accessory (not fitted) - Not proposed

# General Data

## RTWF SE (Standard Efficiency) R134a

		RTWF 100 SE	RTWF 120 SE	RTWF 140 SE	RTWF 150 SE	RTWF 170 SE	RTWF 180 SE	RTWF 190 SE	RTWF 210 SE	RTWF 230 SE
Net cooling capacity (1) (2)	(kW)	368.0	417.0	487.0	544.0	591.0	646.0	702.0	777.0	845.0
Net Power Input (1) (2)	(kW)	71.0	77.2	97.0	105.6	113.7	125.7	141.0	154.5	168.7
Net EER (1) (2)		5.18	5.4	5.02	5.15	5.20	5.14	4.98	5.03	5.01
Eurovent Energy class - Cooling		A	A	B	A	A	A	B	B	B
SEER (3)		6.58	6.63	6.70	6.75	6.85	6.90	6.88	6.83	6.78
Space cooling efficiency $\eta_{s,c}$ (3)	(%)	255	257	260	262	266	268	267	265	263
<b>Compressor</b>										
Circuit 1		2	2	2	2	2	2	2	2	2
Circuit 2		-	-	-	-	-	-	-	-	-
<b>Evaporator</b>										
Pass		2								
Nominal Flow (1)	l/s	17.6	19.9	23.2	25.9	28.2	30.8	33.5	37.0	40.3
Pressure Drop (1)	kPa	52	66	68	62	62	73	71	61	64
Minimum Flow	l/s	8.1	8.1	9.5	10.8	11.8	11.8	12.8	15.5	16.5
Maximum Flow	l/s	35.4	35.4	41.5	47.1	51.5	51.5	55.9	67.7	72.0
Water Connection Type		Grooved end								
Water Connection Size	in	4	4	4	5	5	5	5	5	6
<b>Condenser</b>										
Pass		2								
Nominal Flow (1)	l/s	21.0	23.9	28.0	31.1	33.8	37.0	40.4	44.7	48.6
Pressure Drop (1)	kPa	61	64	71	70	70	61	72	65	59
Minimum Flow	l/s	8.5	9.4	10.5	11.6	12.6	15.0	15.0	17.8	20.8
Maximum Flow	l/s	31.1	34.4	38.4	42.4	46.1	54.9	54.9	65.1	76.1
Water Connection Type		Grooved end								
Water Connection Size	in	5	5	5	6	6	6	6	6	6
<b>Refrigerant</b>										
Type		R134a								
Charge Circuit 1	kg	88	85	97	119	92	116	146	128	127
Charge Circuit 2	kg	-	-	-	-	-	-	-	-	-
<b>Dimensions &amp; Weight</b>										
Length	mm	3080	3080	3080	3080	3080	3160	3160	3160	3160
Width	mm	1190	1190	1190	1190	1190	1225	1250	1250	1250
Height	mm	1900	1900	1900	1935	1935	1935	2035	2035	2080
Operating weight	kg	2622	2641	3048	3194	3215	3456	3783	3884	3988

(1) Evaporator 12/7°C and 0.0 m<sup>2</sup>K/kW, and condenser at 30/35°C and 0.0 m<sup>2</sup>K/kW.

(2) Net performances calculated as per EN 14511-2018.

(3)  $\eta_{s,c}$  / SEER as defined in Directive 2009/125/EC of the European Parliament and of the Council with regard to Ecodesign requirements for Comfort Chillers with 2000 kW maximum capacity - COMMISSION REGULATION (EU) N° 2016/2281 of 20 December 2016.

## General Data

### RTWF SE (Standard Efficiency) R134a

		RTWF 275 SE	RTWF 290 SE	RTWF 310 SE	RTWF 330 SE	RTWF 370 SE	RTWF 410 SE	RTWF 450 SE	RTWF 490 SE
Net cooling capacity (1) (2)	(kW)	939.0	983.0	1043.0	1112.0	1250.0	1397.0	1537.0	1676.0
Net Power Input (1) (2)	(kW)	192.4	202.3	213.7	227.9	258.8	285.1	315.0	342.7
Net EER (1) (2)		4.88	4.86	4.88	4.88	4.83	4.90	4.88	4.89
Eurovent Energy class - Cooling		B	B	B	B	B	B	B	B
SEER (3)		6.55	6.48	6.28	6.48	6.45	7.23	7.30	7.20
Space cooling efficiency $\eta_{s,c}$ (3)	(%)	254	251	243	251	250	281	284	280
<b>Compressor</b>									
Circuit 1		2	2	2	2	2	2	2	2
Circuit 2		1	1	1	1	1	2	2	2
<b>Evaporator</b>									
Pass		1							
Nominal Flow (1)	l/s	44.8	46.9	49.7	53.0	59.6	66.6	73.3	79.9
Pressure Drop (1)	kPa	53	58	58	59	59	59	59	59
Minimum Flow	l/s	18.0	18.0	19.1	20.4	23.3	25.2	28.0	31.0
Maximum Flow	l/s	67.5	67.5	72.0	76.8	87.4	95.3	105.6	115.8
Water Connection Type		Grooved end							
Water Connection Size	in	6	6	6	6	6	8	8	8
<b>Condenser</b>									
Pass		1							
Nominal Flow (1)	l/s	54.3	56.8	60.2	64.2	72.3	80.7	88.8	96.8
Pressure Drop (1)	kPa	62	68	67	67	75	69	72	70
Minimum Flow	l/s	17.8	17.8	19.3	20.8	22.2	24.8	27.1	30.2
Maximum Flow	l/s	66.9	66.9	72.5	78.3	83.5	93.4	102.1	113.6
Water Connection Type		Grooved end							
Water Connection Size	in	6	6	6	6	6	8	8	8
<b>Refrigerant</b>									
Type		R134a							
Charge Circuit 1	kg	161	161	155	163	163	145	150	155
Charge Circuit 2	kg	75	72	69	76	72	144	148	152
<b>Dimensions &amp; Weight</b>									
Length	mm	4754	4754	4784	4784	4784	4774	4774	4774
Width	mm	1727	1727	1727	1727	1727	1823	1823	1823
Height	mm	2032	2032	2032	2032	2032	2135	2135	2135
Operating weight	kg	5276	5273	5456	5511	5574	6945	7025	7109

(1) Evaporator 12/7°C and 0.0 m<sup>2</sup>K/kW, and condenser at 30/35°C and 0.0 m<sup>2</sup>K/kW.

(2) Net performances calculated as per EN 14511-2018.

(3)  $\eta_{s,c}$  / SEER as defined in Directive 2009/125/EC of the European Parliament and of the Council with regard to Ecodesign requirements for Comfort Chillers with 2000 kW maximum capacity - COMMISSION REGULATION (EU) N° 2016/2281 of 20 December 2016.

## General Data

### RTWF HE (High Efficiency) R134a

		RTWF 100 HE	RTWF 120 HE	RTWF 140 HE	RTWF 150 HE	RTWF 170 HE	RTWF 180 HE	RTWF 190 HE	RTWF 210 HE	RTWF 230 HE
Net cooling capacity (1) (2)	(kW)	371.0	429.0	499.0	552.0	600.0	658.0	716.0	787.0	854.0
Net Power Input (1) (2)	(kW)	69.6	80.2	95.8	103.0	110.5	123.7	138.2	151.1	166.8
Net EER (1) (2)		5.33	5.35	5.21	5.36	5.43	5.32	5.18	5.21	5.12
Eurovent Energy class - Cooling		A	A	A	A	A	A	A	A	A
SEER (3)		6.68	6.80	6.90	6.95	7.05	7.08	6.98	6.90	6.83
Space cooling efficiency $\eta_{s,c}$ (3)	(%)	259	264	268	270	274	275	271	268	265
<b>Compressor</b>										
Circuit 1		2	2	2	2	2	2	2	2	2
Circuit 2		-	-	-	-	-	-	-	-	-
<b>Evaporator</b>										
Pass		2								
Nominal Flow (1)	l/s	17.7	20.4	23.8	26.3	28.6	31.4	34.1	37.5	40.7
Pressure Drop (1)	kPa	40	39	52	36	37	39	39	40	47
Minimum Flow	l/s	9.5	10.8	10.8	14.4	15.5	16.5	18.2	20.0	20.0
Maximum Flow	l/s	41.5	47.1	47.1	62.9	67.7	72.0	79.4	87.3	87.3
Water Connection Type		Grooved end								
Water Connection Size	in	4	5	5	5	5	6	6	6	6
<b>Condenser</b>										
Pass		2								
Nominal Flow (1)	l/s	21.2	24.4	28.6	31.5	34.2	37.6	41.0	45.1	49.0
Pressure Drop (1)	kPa	43	45	52	46	40	48	56	42	49
Minimum Flow	l/s	10.5	11.6	12.6	15.0	17.8	17.8	17.8	23.6	23.6
Maximum Flow	l/s	38.4	42.4	46.1	54.9	65.1	65.1	65.1	86.7	86.7
Water Connection Type		Grooved end								
Water Connection Size	in	5	6	6	6	6	6	6	6	6
<b>Refrigerant</b>										
Type		R134a								
Charge Circuit 1	kg	87	90	99	135	110	154	153	141	141
Charge Circuit 2	kg	-	-	-	-	-	-	-	-	-
<b>Dimensions &amp; Weight</b>										
Length	mm	3080	3080	3080	3160	3160	3160	3160	3160	3160
Width	mm	1190	1190	1190	1215	1215	1250	1250	1250	1250
Height	mm	1900	1935	1935	2055	2055	2080	2080	2080	2080
Operating weight	kg	2696	2819	3196	3490	3564	3790	3969	4139	4139

(1) Evaporator 12/7°C and 0.0 m<sup>2</sup>K/kW, and condenser at 30/35°C and 0.0 m<sup>2</sup>K/kW.

(2) Net performances calculated as per EN 14511-2018.

(3)  $\eta_{s,c}$  / SEER as defined in Directive 2009/125/EC of the European Parliament and of the Council with regard to Ecodesign requirements for Comfort Chillers with 2000 kW maximum capacity - COMMISSION REGULATION (EU) N° 2016/2281 of 20 December 2016.

## General Data

### RTWF HE (High Efficiency) R134a

		RTWF 275 HE	RTWF 290 HE	RTWF 310 HE	RTWF 330 HE	RTWF 370 HE	RTWF 410 HE	RTWF 450 HE	RTWF 490 HE
Net cooling capacity (1) (2)	(kW)	957.0	1003.0	1066.0	1134.0	1267.0	1423.0	1563.0	1706.0
Net Power Input (1) (2)	(kW)	181.9	190.7	203.4	216.4	242.7	269.0	298.9	326.2
Net EER (1) (2)		5.26	5.26	5.24	5.24	5.22	5.29	5.23	5.23
Eurovent Energy class - Cooling		A	A	A	A	A	A	A	A
SEER (3)		7.05	7.03	6.78	7.00	7.10	7.60	7.55	7.40
Space cooling efficiency $\eta_{s,c}$ (3)	(%)	274	273	263	272	276	296	294	288
<b>Compressor</b>									
Circuit 1		2	2	2	2	2	2	2	2
Circuit 2		1	1	1	1	1	2	2	2
<b>Evaporator</b>									
Pass		1							
Nominal Flow (1)	l/s	45.6	47.8	50.8	54.1	60.4	67.8	74.5	81.3
Pressure Drop (1)	kPa	44	48	43	49	60	50	51	49
Minimum Flow	l/s	20.4	20.4	23.3	23.3	23.3	28.0	31.0	34.6
Maximum Flow	l/s	76.8	76.8	87.4	87.4	87.4	105.6	115.8	130.1
Water Connection Type		Grooved end							
Water Connection Size	in	6	6	6	6	6	8	8	8
<b>Condenser</b>									
Pass		1							
Nominal Flow (1)	l/s	54.8	57.4	61.0	64.9	72.6	81.3	89.5	97.7
Pressure Drop (1)	kPa	26	29	33	29	24	29	31	29
Minimum Flow	l/s	29.9	29.9	29.9	34.2	45.4	41.4	44	50.1
Maximum Flow	l/s	113.9	113.9	113.9	128.5	171.9	155.7	165.6	189.3
Water Connection Type		Grooved end							
Water Connection Size	in	6	6	6	6	6	8	8	8
<b>Refrigerant</b>									
Type		R134a							
Charge Circuit 1	kg	190	190	193	191	185	176	183	183
Charge Circuit 2	kg	90	86	90	84	81	175	181	180
<b>Dimensions &amp; Weight</b>									
Length	mm	4754	4754	4784	4784	4784	4774	4774	4774
Width	mm	1727	1727	1727	1727	1727	1823	1823	1823
Height	mm	2032	2032	2032	2032	2032	2135	2135	2135
Operating weight	kg	5687	5683	5886	5950	6123	7446	7571	7694

(1) Evaporator 12/7°C and 0.0 m<sup>2</sup>K/kW, and condenser at 30/35°C and 0.0 m<sup>2</sup>K/kW.

(2) Net performances calculated as per EN 14511-2018.

(3)  $\eta_{s,c}$  / SEER as defined in Directive 2009/125/EC of the European Parliament and of the Council with regard to Ecodesign requirements for Comfort Chillers with 2000 kW maximum capacity - COMMISSION REGULATION (EU) N° 2016/2281 of 20 December 2016.

## General Data

### RTWF HSE (High Seasonal Efficiency) R134a

		RTWF 100 HSE	RTWF 120 HSE	RTWF 140 HSE	RTWF 150 HSE	RTWF 170 HSE	RTWF 180 HSE	RTWF 190 HSE	RTWF 210 HSE	RTWF 230 HSE	RTWF 250 HSE
Net cooling capacity (1) (2)	(kW)	374.0	432.0	501.0	555.0	603.0	658.0	716.0	782.0	849.0	930.0
Net Power Input (1) (2)	(kW)	71.4	81.8	96.7	104.3	111.7	126.3	121.0	153.3	169.1	191.8
Net EER (1) (2)		5.24	5.28	5.18	5.32	5.40	5.21	5.09	5.10	5.02	4.85
Eurovent Energy class - Cooling		A	A	A	A	A	A	A	A	B	B
SEER (3)		6.73	6.93	7.00	7.08	7.15	7.18	7.05	6.98	6.88	6.83
Space cooling efficiency $\eta_{s,c}$ (3)	(%)	261	269	272	275	278	279	274	271	267	265
<b>Compressor</b>											
Circuit 1		2	2	2	2	2	2	2	2	2	2
Circuit 2		-	-	-	-	-	-	-	-	-	-
<b>Evaporator</b>											
Pass		2									
Nominal Flow (1)	l/s	17.9	20.6	23.9	26.4	28.7	31.4	34.1	37.3	40.5	44
Pressure Drop (1)	kPa	41	39	53	36	37	39	39	39	46	55
Minimum Flow	l/s	9.5	10.8	10.8	14.4	15.5	16.5	18.2	20.0	20.0	20.0
Maximum Flow	l/s	41.5	47.1	47.1	62.9	67.7	72.0	79.4	87.3	87.3	87.3
Water Connection Type		Grooved end									
Water Connection Size	in	4	5	5	5	5	6	6	6	6	6
<b>Condenser</b>											
Pass		2									
Nominal Flow (1)	l/s	21.4	24.7	28.7	31.6	34.3	37.6	41.1	44.9	48.8	53.8
Pressure Drop (1)	kPa	44	46	52	46	40	48	56	42	49	58
Minimum Flow	l/s	10.5	11.6	12.6	15.0	17.8	17.8	17.8	23.6	23.6	23.6
Maximum Flow	l/s	38.4	42.4	46.1	54.9	65.1	65.1	65.1	86.7	86.7	86.7
Water Connection Type		Grooved end									
Water Connection Size	in	5	6	6	6	6	6	6	6	6	6
<b>Refrigerant</b>											
Type		R134a									
Charge Circuit 1	kg	87	90	99	135	110	154	153	141	141	141
Charge Circuit 2	kg	-	-	-	-	-	-	-	-	-	-
<b>Dimensions &amp; Weight</b>											
Length	mm	3080	3080	3080	3160	3160	3160	3160	3160	3160	3160
Width	mm	1260	1260	1260	1285	1285	1380	1380	1380	1380	1380
Height	mm	1900	1935	1935	2055	2055	2080	2080	2080	2080	2080
Operating weight	kg	2796	2919	3296	3590	3670	3890	4069	4239	4239	4239

(1) Evaporator 12/7°C and 0.0 m<sup>2</sup>K/kW, and condenser at 30/35°C and 0.0 m<sup>2</sup>K/kW.

(2) Net performances calculated as per EN 14511-2018.

(3)  $\eta_{s,c}$  / SEER as defined in Directive 2009/125/EC of the European Parliament and of the Council with regard to Ecodesign requirements for Comfort Chillers with 2000 kW maximum capacity - COMMISSION REGULATION (EU) N° 2016/2281 of 20 December 2016.

## General Data

### RTWF HSE (High Seasonal Efficiency) R134a

		RTWF 275 HSE	RTWF 290 HSE	RTWF 310 HSE	RTWF 330 HSE	RTWF 370 HSE	RTWF 410 HSE	RTWF 450 HSE	RTWF 490 HSE	RTWF 515 HSE
Net cooling capacity (1) (2)	(kW)	959.0	1005.0	1066.0	1134.0	1258.0	1423.0	1563.0	1697.0	1859.0
Net Power Input (1) (2)	(kW)	185.5	194.4	208.2	221.5	246.7	274.2	303.5	330.2	375.6
Net EER (1) (2)		5.17	5.17	5.12	5.12	5.10	5.19	5.15	5.14	4.95
Eurovent Energy class - Cooling		A	A	A	A	A	A	A	A	B
SEER (3)		7.18	7.20	7.38	7.35	7.33	7.43	7.28	7.28	7.23
Space cooling efficiency $\eta_{s,c}$ (3)	(%)	279	280	287	286	285	289	283	283	281
<b>Compressor</b>										
Circuit 1		2	2	2	2	2	2	2	2	2
Circuit 2		1	1	1	1	1	2	2	2	2
<b>Evaporator</b>										
Pass						1				
Nominal Flow (1)	l/s	45.7	47.9	50.8	54.1	60.0	67.8	74.5	80.9	88.6
Pressure Drop (1)	kPa	44	48	43	49	60	50	51	48	58
Minimum Flow	l/s	20.4	20.4	23.3	23.3	23.3	28.0	31.0	34.6	34.6
Maximum Flow	l/s	76.8	76.8	87.4	87.4	87.4	105.6	115.8	130.1	130.1
Water Connection Type						Grooved end				
Water Connection Size	in	6	6	6	6	6	8	8	8	8
<b>Condenser</b>										
Pass						1				
Nominal Flow (1)	l/s	54.9	57.6	61.1	65.0	72.2	81.5	89.6	97.3	107.2
Pressure Drop (1)	kPa	26	29	33	30	24	29	31	29	35
Minimum Flow	l/s	29.9	29.9	29.9	34.2	45.4	41.4	44	50.1	50.1
Maximum Flow	l/s	113.9	113.9	113.9	128.5	171.9	155.7	165.6	189.3	189.3
Water Connection Type						Grooved end				
Water Connection Size	in	6	6	6	6	6	8	8	8	8
<b>Refrigerant</b>										
Type						R134a				
Charge Circuit 1	kg	190	190	193	191	185	176	183	183	183
Charge Circuit 2	kg	90	86	90	84	81	175	181	180	179
<b>Dimensions &amp; Weight</b>										
Length	mm	4754	4754	4784	4784	4784	4774	4774	4774	4774
Width	mm	1727	1727	1727	1727	1727	1823	1823	1823	1823
Height	mm	2032	2032	2032	2032	2032	2135	2135	2135	2135
Operating weight	kg	5862	5858	6100	6164	6337	7660	7785	7908	7907

(1) Evaporator 12/7°C and 0.0 m<sup>2</sup>K/kW, and condenser at 30/35°C and 0.0 m<sup>2</sup>K/kW.

(2) Net performances calculated as per EN 14511-2018.

(3)  $\eta_{s,c}$  / SEER as defined in Directive 2009/125/EC of the European Parliament and of the Council with regard to Ecodesign requirements for Comfort Chillers with 2000 kW maximum capacity - COMMISSION REGULATION (EU) N° 2016/2281 of 20 December 2016.



## General Data

### RTWF SE (Standard Efficiency) R513A

		RTWF 100 SE	RTWF 120 SE	RTWF 140 SE	RTWF 150 SE	RTWF 170 SE	RTWF 180 SE	RTWF 190 SE	RTWF 210 SE	RTWF 230 SE
Net cooling capacity (1) (2)	(kW)	367.0	415.0	485.0	542.0	589.0	643.0	700.0	774.0	841.0
Net Power Input (1) (2)	(kW)	72.8	83.7	99.4	108.4	116.9	128.9	142.0	158.9	173.4
Net EER (1) (2)		5.04	4.96	4.88	5.00	5.04	4.99	4.83	4.87	4.85
Eurovent Energy class - Cooling		B	B	B	B	B	B	B	B	B
SEER (3)		5.98	6.45	6.50	6.55	6.65	6.73	6.70	6.65	6.58
Space cooling efficiency $\eta_{s,c}$ (3)	(%)	231	250	252	254	258	261	260	258	255
<b>Compressor</b>										
Circuit 1		2	2	2	2	2	2	2	2	2
Circuit 2		-	-	-	-	-	-	-	-	-
<b>Evaporator</b>										
Pass		2								
Nominal Flow (1)	l/s	17.5	19.8	23.1	25.8	28.1	30.7	33.4	36.9	40.1
Pressure Drop (1)	kPa	51	65	67	61	61	73	71	61	64
Minimum Flow	l/s	8.1	8.1	9.5	10.8	11.8	11.8	12.8	15.5	16.5
Maximum Flow	l/s	35.4	35.4	41.5	47.1	51.5	51.5	55.9	67.7	72.0
Water Connection Type		Grooved end								
Water Connection Size	in	4	4	4	5	5	5	5	5	6
<b>Condenser</b>										
Pass		2								
Nominal Flow (1)	l/s	21.1	23.9	28.0	31.2	33.8	37.0	40.5	44.7	48.7
Pressure Drop (1)	kPa	61	64	71	70	70	61	72	65	59
Minimum Flow	l/s	8.5	9.4	10.5	11.6	12.6	15.0	15.0	17.8	20.8
Maximum Flow	l/s	31.1	34.4	38.4	42.4	46.1	54.9	54.9	65.1	76.1
Water Connection Type		Grooved end								
Water Connection Size	in	5	5	5	6	6	6	6	6	6
<b>Refrigerant</b>										
Type		R134a								
Charge Circuit 1	kg	88	85	97	119	92	116	146	128	127
Charge Circuit 2	kg	-	-	-	-	-	-	-	-	-
<b>Dimensions &amp; Weight</b>										
Length	mm	3080	3080	3080	3080	3080	3160	3160	3160	3160
Width	mm	1190	1190	1190	1190	1190	1225	1250	1250	1250
Height	mm	1900	1900	1900	1935	1935	1935	2035	2035	2080
Operating weight	kg	2622	2641	3048	3194	3215	3456	3783	3884	3988

(1) Evaporator 12/7°C and 0.0 m<sup>2</sup>K/kW, and condenser at 30/35°C and 0.0 m<sup>2</sup>K/kW.

(2) Net performances calculated as per EN 14511-2018.

(3)  $\eta_{s,c}$  / SEER as defined in Directive 2009/125/EC of the European Parliament and of the Council with regard to Ecodesign requirements for Comfort Chillers with 2000 kW maximum capacity - COMMISSION REGULATION (EU) N° 2016/2281 of 20 December 2016.

## General Data

### RTWF HE (High Efficiency) R513A

		RTWF 100 HE	RTWF 120 HE	RTWF 140 HE	RTWF 150 HE	RTWF 170 HE	RTWF 180 HE	RTWF 190 HE	RTWF 210 HE	RTWF 230 HE
Net cooling capacity (1) (2)	(kW)	370.0	427.0	498.0	550.0	598.0	656.0	713.0	783.0	850.0
Net Power Input (1) (2)	(kW)	71.4	82.3	98.4	105.8	113.7	127.1	142.0	155.4	171.7
Net EER (1) (2)		5.18	5.19	5.06	5.20	5.26	5.16	5.02	5.04	4.95
Eurovent Energy class - Cooling		A	A	A	A	A	A	B	B	B
SEER (3)		5.95	6.65	6.73	6.78	6.85	6.88	6.78	6.70	6.63
Space cooling efficiency $\eta_{s,c}$ (3)	(%)	230	258	261	263	266	267	263	260	257
<b>Compressor</b>										
Circuit 1		2	2	2	2	2	2	2	2	2
Circuit 2		-	-	-	-	-	-	-	-	-
<b>Evaporator</b>										
Pass						2				
Nominal Flow (1)	l/s	17.6	20.4	23.7	26.2	28.5	31.3	34.0	37.3	40.5
Pressure Drop (1)	kPa	40	38	52	36	37	39	39	39	46
Minimum Flow	l/s	9.5	10.8	10.8	14.4	15.5	16.5	18.2	20.0	20.0
Maximum Flow	l/s	41.5	47.1	47.1	62.9	67.7	72.0	79.4	87.3	87.3
Water Connection Type							Grooved end			
Water Connection Size	in	4	5	5	5	5	6	6	6	6
<b>Condenser</b>										
Pass						2				
Nominal Flow (1)	l/s	21.2	24.5	28.6	31.5	34.2	37.6	41.1	45.1	49.1
Pressure Drop (1)	kPa	43	45	52	46	40	48	56	42	49
Minimum Flow	l/s	10.5	11.6	12.6	15.0	17.8	17.8	17.8	23.6	23.6
Maximum Flow	l/s	38.4	42.4	46.1	54.9	65.1	65.1	65.1	86.7	86.7
Water Connection Type							Grooved end			
Water Connection Size	in	5	6	6	6	6	6	6	6	6
<b>Refrigerant</b>										
Type						R134a				
Charge Circuit 1	kg	87	90	99	135	110	154	153	141	141
Charge Circuit 2	kg	-	-	-	-	-	-	-	-	-
<b>Dimensions &amp; Weight</b>										
Length	mm	3080	3080	3080	3160	3160	3160	3160	3160	3160
Width	mm	1190	1190	1190	1215	1215	1250	1250	1250	1250
Height	mm	1900	1935	1935	2055	2055	2080	2080	2080	2080
Operating weight	kg	2696	2819	3196	3490	3564	3790	3969	4139	4139

(1) Evaporator 12/7°C and 0.0 m<sup>2</sup>K/kW, and condenser at 30/35°C and 0.0 m<sup>2</sup>K/kW.

(2) Net performances calculated as per EN 14511-2018.

(3)  $\eta_{s,c}$  / SEER as defined in Directive 2009/125/EC of the European Parliament and of the Council with regard to Ecodesign requirements for Comfort Chillers with 2000 kW maximum capacity - COMMISSION REGULATION (EU) N° 2016/2281 of 20 December 2016.

## General Data

### RTHF XE (eXtra High Efficiency) R134a

		RTHF 330 XE	RTHF 360 XE	RTHF 410 XE	RTHF 460 XE	RTHF 500 XE	RTHF 540 XE
Gross Cooling Capacity (1)	(kW)	1156	1269	1468	1584	1778	1898
Gross Power Input (1)	(kW)	190.0	212.7	246.5	265.9	299.6	318.2
Gross EER (1)		6.08	5.97	5.96	5.96	5.94	5.96
Net cooling capacity (1) (2)	(kW)	1155.5	1268.5	1467.0	1583.7	1777.3	1897.3
Net Power Input (1) (2)	(kW)	193.6	193.6	193.6	193.6	193.6	193.6
Net EER (1) (2)		5.97	5.84	5.83	5.81	5.76	5.77
Eurovent Energy class - Cooling		A	A	A	A	A	A
SEER (3)		7.47	7.35	7.30	7.26	7.38	7.50
Space cooling efficiency $\eta_{s,c}$ (3)	(%)	291	286	284	283	287	292
<b>Compressor</b>							
Circuit 1		1	1	1	1	1	1
Circuit 2		1	1	1	1	1	1
<b>Evaporator</b>							
Pass		1					
Nominal Flow (1)	l/s	55.1	60.4	69.9	75.5	84.7	90.4
Pressure Drop (1)	kPa	23	27.7	29.4	34.1	42.8	48.6
Minimum Flow	l/s	34.6	34.6	39.4	39.4	39.4	39.4
Maximum Flow	l/s	127.4	127.4	144.6	144.6	144.6	144.6
Water Connection Type		Grooved end					
Water Connection Size	in	8	8	8	8	8	8
<b>Condenser</b>							
Pass		1					
Nominal Flow (1)	l/s	64.98	71.53	82.76	89.34	100.3	107
Pressure Drop (1)	kPa	13.2	15.9	17.7	20.6	25.8	29.3
Minimum Flow	l/s	50.3	50.3	56.7	56.7	56.7	56.7
Maximum Flow	l/s	184.2	184.2	207.7	207.7	207.7	207.7
Water Connection Type		Grooved end					
Water Connection Size	in	8	8	8	8	8	8
<b>Refrigerant</b>							
Type		R134a					
Charge Circuit 1	kg	176	180	181	178	197	197
Charge Circuit 2	kg	174	180	181	180	202	199
<b>Dimensions &amp; Weight</b>							
Length	mm	4586	4586	4586	4586	4586	4586
Width	mm	1840	1840	1840	1840	1840	1840
Height	mm	2395	2395	2395	2395	2395	2395
Operating weight	kg	7350	7450	7450	8590	8590	9630

(1) Evaporator 12/7°C and 0.0 m<sup>2</sup>K/kW, and condenser at 30/35°C and 0.0 m<sup>2</sup>K/kW.

(2) Net performances calculated as per EN 14511-2018.

(3)  $\eta_{s,c}$  / SEER as defined in Directive 2009/125/EC of the European Parliament and of the Council with regard to Ecodesign requirements for Comfort Chillers with 2000 kW maximum capacity - COMMISSION REGULATION (EU) N° 2016/2281 of 20 December 2016.

## General Data

### RTHF XE (eXtra High Efficiency) R134a (continued)

		RTHF 600 XE	RTHF 650 XE	RTHF 700 XE	RTHF 750 XE	RTHF 800 XE	RTHF 840 XE
Gross Cooling Capacity (1)	(kW)	2112	2252	2513	2650	2830	3013
Gross Power Input (1)	(kW)	330.3	361.2	392.5	421.5	459.0	495.6
Gross EER (1)		6.40	6.24	6.40	6.29	6.17	6.08
Net cooling capacity (1) (2)	(kW)	2109.1	2248.9	2509.4	2644.4	2824.8	3007.9
Net Power Input (1) (2)	(kW)	193.6	193.6	193.6	193.6	193.6	193.6
Net EER (1) (2)		6.21	6.03	6.15	6.02	5.88	5.77
Eurovent Energy class - Cooling		A	A	A	A	A	A
SEER (3)		7.99	7.85	7.98	7.59	7.54	7.32
Space cooling efficiency $\eta_{s,c}$ (3)	(%)	312	306	311	295	294	285
<b>Compressor</b>							
Circuit 1		1	1	1	1	1	1
Circuit 2		1	1	1	1	1	1
<b>Evaporator</b>							
Pass		1					
Nominal Flow (1)	l/s	100.6	107.3	119.7	126.2	134.8	143.5
Pressure Drop (1)	kPa	23.4	26.5	32.9	36.5	41.5	46.9
Minimum Flow	l/s	63.8	63.8	63.8	63.8	63.8	63.8
Maximum Flow	l/s	234.0	234.0	234.0	234.0	234.0	234.0
Water Connection Type		Grooved end					
Water Connection Size	in	10	10	10	10	10	10
<b>Condenser</b>							
Pass		1					
Nominal Flow (1)	l/s	117.9	126.2	140.3	148.3	158.8	169.4
Pressure Drop (1)	kPa	17.6	20.2	25.2	28.2	32.4	37
Minimum Flow	l/s	90.9	90.9	90.9	90.9	90.9	90.9
Maximum Flow	l/s	333.2	333.2	333.2	333.2	333.2	333.2
Water Connection Type		Grooved end					
Water Connection Size	in	10	10	10	10	10	10
<b>Refrigerant</b>							
Type		R134a					
Charge Circuit 1	kg	283	283	280	280	275	275
Charge Circuit 2	kg	296	282	279	279	279	274
<b>Dimensions &amp; Weight</b>							
Length	mm	5521	5521	5521	5521	5521	5521
Width	mm	2088	2088	2088	2088	2088	2088
Height	mm	2457	2457	2457	2457	2457	2457
Operating weight	kg	9680	13380	13380	13380	13490	13610

(1) Evaporator 12/7°C and 0.0 m<sup>2</sup>K/kW, and condenser at 30/35°C and 0.0 m<sup>2</sup>K/kW.

(2) Net performances calculated as per EN 14511-2018.

(3)  $\eta_{s,c}$  / SEER as defined in Directive 2009/125/EC of the European Parliament and of the Council with regard to Ecodesign requirements for Comfort Chillers with 2000 kW maximum capacity - COMMISSION REGULATION (EU) N° 2016/2281 of 20 December 2016.

## General Data

### RTHF HSE (High Seasonal Efficiency) R134a

		RTHF 330 HSE	RTHF 360 HSE	RTHF 410 HSE	RTHF 460 HSE	RTHF 500 HSE	RTHF 540 HSE	RTHF 590 HSE	RTHF 640 HSE	RTHF 600 HSE
Gross Cooling Capacity (1)	(kW)	1154	1268	1467	1582	1773	1892	2084	2272	2107
Gross Power Input (1)	(kW)	195.1	217.6	250.9	271.5	304.7	324.4	367.0	411.6	335.5
Gross EER (1)		5.92	5.83	5.85	5.83	5.82	5.83	5.68	5.52	6.28
Net cooling capacity (1) (2)	(kW)	1153.2	1267.0	1466.0	1581.1	1771.7	1890.7	2083.4	2270.6	2104.0
Net Power Input (1) (2)	(kW)	198.5	221.9	256.3	277.9	313.0	334.6	380.2	428.4	345.5
Net EER (1) (2)		5.81	5.71	5.72	5.69	5.66	5.65	5.48	5.30	6.09
Eurovent Energy class - Cooling		A	A	A	A	A	A	A	A	A
SEER (3)		8.65	8.66	8.63	8.76	8.82	9.00	8.82	8.69	9.56
Space cooling efficiency $\eta_{s,c}$ (3)	(%)	338.1	338.3	337.1	342.3	344.6	351.9	344.7	340	374
<b>Compressor</b>										
Circuit 1		1	1	1	1	1	1	1	1	1
Circuit 2		1	1	1	1	1	1	1	1	1
<b>Evaporator</b>										
Pass		1								
Nominal Flow (1)	l/s	54.94	60.37	69.85	75.33	84.41	90.08	99.27	108.2	100.3
Pressure Drop (1)	kPa	22.9	27.6	29.3	34	42.5	48.2	58.3	68.9	23.3
Minimum Flow	l/s	34.6	34.6	39.4	39.4	39.4	39.4	39.4	39.4	63.8
Maximum Flow	l/s	127.4	127.4	144.6	144.6	144.6	144.6	144.6	144.6	234.0
Water Connection Type		Grooved end								
Water Connection Size	in	8	8	8	8	8	8	8	8	10
<b>Condenser</b>										
Pass		1								
Nominal Flow (1)	l/s	64.92	71.48	82.7	89.22	100	106.7	118.1	129.3	117.7
Pressure Drop (1)	kPa	13.1	15.9	17.7	20.5	25.7	29.1	35.5	42.3	17.5
Minimum Flow	l/s	50.3	50.3	56.7	56.7	56.7	56.7	56.7	56.7	90.9
Maximum Flow	l/s	184.2	184.2	207.7	207.7	207.7	207.7	207.7	207.7	333.2
Water Connection Type		Grooved end								
Water Connection Size	in	8	8	8	8	8	8	8	8	10
<b>Refrigerant</b>										
Type		R134a								
Charge Circuit 1	kg	176	180	181	178	197	197	196	194	283
Charge Circuit 2	kg	174	180	181	180	202	199	197	196	296
<b>Dimensions &amp; Weight</b>										
Length	mm	4586	4586	4586	4586	4586	4586	4586	4586	5521
Width	mm	1940	1940	1940	1940	1940	1940	1940	1940	2088
Height	mm	2395	2395	2395	2395	2395	2395	2395	2395	2457
Operating weight	kg	7520	7620	8820	8820	9920	9970	9970	9970	13440

(1) Evaporator 12/7°C and 0.0 m<sup>2</sup>K/kW, and condenser at 30/35°C and 0.0 m<sup>2</sup>K/kW.

(2) Net performances calculated as per EN 14511-2018.

(3)  $\eta_{s,c}$  / SEER as defined in Directive 2009/125/EC of the European Parliament and of the Council with regard to Ecodesign requirements for Comfort Chillers with 2000 kW maximum capacity - COMMISSION REGULATION (EU) N° 2016/2281 of 20 December 2016.

## General Data

### RTHF HSE (High Seasonal Efficiency) R134a (continued)

		RTHF 650 HSE	RTHF 700 HSE	RTHF 750 HSE	RTHF 800 HSE	RTHF 840 HSE	RTHF 850 HSE	RTHF 900 HSE	RTHF 950 HSE	RTHF K00 HSE
Gross Cooling Capacity (1)	(kW)	2242	2503	2641	2821	3001	3001	3225	3449	3672
Gross Power Input (1)	(kW)	367.6	399.1	427.8	465.3	503.7	505.3	571.8	639.9	710.4
Gross EER (1)		6.10	6.27	6.17	6.06	5.96	5.94	5.64	5.39	5.17
Net cooling capacity (1) (2)	(kW)	2238.9	2499.2	2635.3	2815.0	2995.1	2995.1	3219.9	3445.1	3671.7
Net Power Input (1) (2)	(kW)	379.5	414.5	445.9	487.0	529.2	531.0	604.1	679.5	758.6
Net EER (1) (2)		5.90	6.03	5.91	5.78	5.66	5.64	5.33	5.07	4.84
Eurovent Energy class - Cooling		A	A	A	A	A	A	A	A	B
SEER (3)		9.38	9.40	9.31	9.21	9.10	9.08	8.93	8.79	8.66
Space cooling efficiency $\eta_{s,c}$ (3)	(%)	367	368	364	360	356	355	349	344	338
<b>Compressor</b>										
Circuit 1		1	1	1	1	1	1	1	1	1
Circuit 2		1	1	1	1	1	1	1	1	1
<b>Evaporator</b>										
Pass		1								
Nominal Flow (1)	l/s	106.8	119.2	125.8	134.3	142.9	142.9	153.6	164.2	174.9
Pressure Drop (1)	kPa	26.3	32.7	36.3	41.3	46.6	46.6	53.6	61	69
Minimum Flow	l/s	63.8	63.8	63.8	63.8	63.8	63.8	63.8	63.8	63.8
Maximum Flow	l/s	234.0	234.0	234.0	234.0	234.0	234.0	234.0	234.0	234.0
Water Connection Type		Grooved end								
Water Connection Size	in	10	10	10	10	10	10	10	10	10
<b>Condenser</b>										
Pass		1								
Nominal Flow (1)	l/s	125.8	139.8	147.9	158.3	168.8	168.8	182.9	197	211.1
Pressure Drop (1)	kPa	20.1	25	28	32.2	36.7	36.7	43.2	50.1	57.6
Minimum Flow	l/s	90.9	90.9	90.9	90.9	90.9	90.9	90.9	90.9	90.9
Maximum Flow	l/s	333.2	333.2	333.2	333.2	333.2	333.2	333.2	333.2	333.2
Water Connection Type		Grooved end								
Water Connection Size	in	10	10	10	10	10	10	10	10	10
<b>Refrigerant</b>										
Type		R134a								
Charge Circuit 1	kg	283	280	280	275	275	275	275	275	275
Charge Circuit 2	kg	282	279	279	279	274	274	274	274	274
<b>Dimensions &amp; Weight</b>										
Length	mm	5521	5521	5521	5521	5521	5521	5521	5521	5521
Width	mm	2088	2088	2088	2088	2088	2305	2305	2305	2305
Height	mm	2457	2457	2457	2457	2457	2457	2457	2457	2457
Operating weight	kg	13740	13740	13740	13850	13970	14570	14570	14570	14570

(1) Evaporator 12/7°C and 0.0 m<sup>2</sup>K/kW, and condenser at 30/35°C and 0.0 m<sup>2</sup>K/kW.

(2) Net performances calculated as per EN 14511-2018.

(3)  $\eta_{s,c}$  / SEER as defined in Directive 2009/125/EC of the European Parliament and of the Council with regard to Ecodesign requirements for Comfort Chillers with 2000 kW maximum capacity - COMMISSION REGULATION (EU) N° 2016/2281 of 20 December 2016.

## General Data

### RTHF XSE (Extra High Seasonal Efficiency) R134a

		855 XSE	905 XSE	945 XSE	995 XSE
Gross Cooling Capacity (1)	(kW)	2973	3189	3407	3633
Gross Power Input (1)	(kW)	520	585	649	729
Gross EER (1)		5.72	5.45	5.25	4.98
IPLV (2)		10.240	9.990	9.770	9.570
Net cooling capacity (1) (3)	(kW)	2972	3188	3407	3633
Net Power Input (1) (3)	(kW)	536	605	673	758
Net EER (1) (3)		5.55	5.27	5.06	4.79
Eurovent Energy class - Cooling		A	A	A	B
SEER (4)		10.13	9.88	9.70	9.50
Space cooling efficiency $\eta_{s,c}$ (4)	(%)	397	387	380	372
<b>Compressor</b>					
Circuit 1				1	
Circuit 2				1	
<b>Evaporator</b>					
Pass				1	
Nominal Flow (1)	l/s	142	152	162	173
Pressure Drop (1)	kPa	46	52	60	68
Minimum Flow	l/s	63.8	63.8	63.8	63.8
Maximum Flow	l/s	234.0	234.0	234.0	234.0
Water Connection Type				Grooved end	
Water Connection Size	in	10	10	10	10
<b>Condenser</b>					
Pass				1	
Nominal Flow (1)	l/s	168	182	196	210
Pressure Drop (1)	kPa	37	43	49	57
Minimum Flow	l/s	90.9	90.9	90.9	90.9
Maximum Flow	l/s	333.2	333.2	333.2	333.2
Water Connection Type				Grooved end	
Water Connection Size	in	10	10	10	10
<b>Refrigerant</b>					
Type				R134a	
Charge Circuit 1	kg	275	275	275	275
Charge Circuit 2	kg	275	275	275	275
<b>Dimensions &amp; Weight</b>					
Length	mm	5521	5521	5521	5521
Width	mm	2305	2305	2305	2305
Height	mm	2457	2457	2457	2457
Operating weight	kg	14360	14470	14590	14590

(1) Evaporator 12/7°C and 0.0 m<sup>2</sup>K/kW, and condenser at 30/35°C and 0.0 m<sup>2</sup>K/kW.

(2) According to AHRI Standard 551/591, based on TOPSS (Trane Official Product Selection Software).

(3) Net performances calculated as per EN 14511-2018.

(4)  $\eta_{s,c}$  / SEER as defined in Directive 2009/125/EC of the European Parliament and of the Council with regard to Ecodesign requirements for Comfort Chillers with 2000 kW maximum capacity - COMMISSION REGULATION (EU) N° 2016/2281 of 20 December 2016.

# Heating Performance

		40/45°C Entering/Leaving Condenser 10/7°C Entering/Leaving Evaporator		47/55°C Entering/Leaving Condenser 10/7°C Entering/Leaving Evaporator			Space Heating efficiency $\eta_{s,h}$ (%) (2)
		Net Heating Cap (kW)(1)	Net COP(1)	Net Heating Cap (kW)(1)	Net COP(1)	SCOP(2)	
RTWF 100 SE	R134a	389.5	4.19	372.9	3.56	4.65	178
RTWF 120 SE	R134a	453.9	4.22	438.1	3.62	4.83	185
RTWF 140 SE	R134a	523.8	4.33	492.8	3.58	4.98	191
RTWF 150 SE	R134a	584.1	4.39	567.5	3.78	5.05	194
RTWF 170 SE	R134a	636.0	4.39	599.5	3.67	5.08	195
RTWF 180 SE	R134a	695.2	4.35	655.6	3.64	5.00	192
RTWF 190 SE	R134a	758.1	4.31	716.2	3.61	5.00	192
RTWF 210 SE	R134a	826.1	4.39	780.1	3.67	5.10	196
RTWF 230 SE	R134a	889.6	4.42	840.5	3.68	5.05	194
RTWF 275 SE	R134a	1035.4	4.40	975.8	3.67	5.13	197
RTWF 290 SE	R134a	1085.9	4.37	1023.9	3.66	5.10	196
RTWF 310 SE	R134a	1149.3	4.38	1083.1	3.67	5.05	194
RTWF 330 SE	R134a	1215.3	4.40	1146.0	3.69	5.13	197
RTWF 370 SE	R134a	1346.4	4.42	1270.6	3.71	5.15	198
RTWF 410 SE	R134a	1537.4	4.39	1449.0	3.68	5.23	201
RTWF 450 SE	R134a	1669.7	4.42	1574.7	3.71	5.35	206
RTWF 490 SE	R134a	1800.7	4.46	1699.0	3.74	5.35	206
RTWF 100 HE	R134a	391.1	4.27	369.2	3.55	4.65	178
RTWF 120 HE	R134a	463.3	4.38	442.9	3.69	4.88	187
RTWF 140 HE	R134a	533.8	4.46	512.1	3.75	5.00	192
RTWF 150 HE	R134a	589.9	4.54	564.4	3.81	5.08	195
RTWF 170 HE	R134a	641.9	4.56	610.9	3.82	5.10	196
RTWF 180 HE	R134a	695.6	4.61	657.3	3.82	5.28	203
RTWF 190 HE	R134a	750.2	4.66	711.3	3.87	5.28	203
RTWF 210 HE	R134a	822.2	4.68	778.2	3.88	5.30	204
RTWF 230 HE	R134a	892.6	4.73	845.1	3.93	5.38	207
RTWF 275 HE	R134a	1045.6	4.61	986.2	3.82	5.20	200
RTWF 290 HE	R134a	1097.1	4.59	1035.3	3.81	5.20	200
RTWF 310 HE	R134a	1164.3	4.59	1098.3	3.82	5.15	198
RTWF 330 HE	R134a	1228.0	4.62	1158.8	3.84	5.20	200
RTWF 370 HE	R134a	1352.9	4.64	1276.5	3.86	5.20	200
RTWF 410 HE	R134a	1551.0	4.60	1462.8	3.83	5.28	203
RTWF 450 HE	R134a	1683.2	4.63	1588.7	3.85	5.38	207
RTWF 490 HE	R134a	1817.0	4.67	1715.1	3.88	5.38	207
RTWF 100 HSE	R134a	396.9	4.22	375.5	3.50	4.60	176
RTWF 120 HSE	R134a	465.9	4.32	446.2	3.63	4.75	182
RTWF 140 HSE	R134a	534.2	4.43	512.8	3.73	5.00	192
RTWF 150 HSE	R134a	592.2	4.50	567.3	3.78	5.00	192
RTWF 170 HSE	R134a	644.2	4.52	613.8	3.79	5.03	193
RTWF 180 HSE	R134a	692.3	4.54	653.8	3.73	5.10	196
RTWF 190 HSE	R134a	746.9	4.58	707.8	3.78	5.10	196
RTWF 210 HSE	R134a	818.3	4.60	774.0	3.79	5.13	197
RTWF 230 HSE	R134a	888.7	4.65	841.0	3.85	5.23	201
RTWF 250 HSE	R134a	966.1	4.54	917.5	3.78	5.15	198
RTWF 275 HSE	R134a	1048.6	4.55	990.3	3.76	5.25	202
RTWF 290 HSE	R134a	1102.1	4.53	1041.5	3.76	5.23	201
RTWF 310 HSE	R134a	1169.8	4.52	1105.2	3.74	5.25	202
RTWF 330 HSE	R134a	1233.4	4.54	1165.7	3.77	5.25	202
RTWF 370 HSE	R134a	1376.5	4.52	1300.9	3.76	5.25	202
RTWF 410 HSE	R134a	1556.6	4.54	1469.8	3.77	5.30	204
RTWF 450 HSE	R134a	1688.8	4.57	1595.8	3.80	5.35	206
RTWF 490 HSE	R134a	1841.0	4.58	1739.8	3.81	5.38	207
RTWF 515 HSE	R134a	2019.0	4.49	1912.3	3.76	5.30	204



## Heating Performance

	40/45°C Entering/Leaving Condenser 10/7°C Entering/Leaving Evaporator		47/55°C Entering/Leaving Condenser 10/7°C Entering/Leaving Evaporator			Space Heating efficiency $\eta_{s,h}$ (%) (2)
	Net Heating Cap (kW)(1)	Net COP(1)	Net Heating Cap (kW)(1)	Net COP(1)	SCOP(2)	
RTWF 100 SE R513A	386.2	4.05	366.5	3.41	4.65	178
RTWF 120 SE R513A	449.9	4.08	430.2	3.47	4.68	179
RTWF 140 SE R513A	513.1	4.18	492.0	3.53	4.8	184
RTWF 150 SE R513A	575.3	4.24	555.6	3.63	4.9	188
RTWF 170 SE R513A	628.5	4.25	606.1	3.64	4.95	190
RTWF 180 SE R513A	688.3	4.22	657.7	3.58	4.85	186
RTWF 190 SE R513A	752.2	4.19	726.4	3.60	4.88	187
RTWF 210 SE R513A	828.9	4.26	749.9	3.60	4.98	191
RTWF 230 SE R513A	901.2	4.27	772.5	3.58	4.98	191
RTWF 100 HE R513A	387.7	4.13	362.2	3.39	4.43	177
RTWF 120 HE R513A	459.4	4.23	435.0	3.53	4.53	181
RTWF 140 HE R513A	523.3	4.30	498.8	3.59	4.65	186
RTWF 150 HE R513A	580.8	4.38	552.0	3.65	4.7	188
RTWF 170 HE R513A	634.1	4.40	598.8	3.65	4.73	189
RTWF 180 HE R513A	688.1	4.46	655.3	3.74	4.95	198
RTWF 190 HE R513A	742.9	4.50	712.9	3.81	4.95	198
RTWF 210 HE R513A	813.9	4.52	769.9	3.76	4.98	199
RTWF 230 HE R513A	883.6	4.57	839.1	3.83	5.03	201

(1) Net performances calculated as per EN 14511-2013.

(2)  $\eta_{s,h}$  / SCOP as defined in Directive 2009/125/EC of the European Parliament and of the Council with regard to Ecodesign requirements for space heaters with 400 kW maximum rated capacity - COMMISSION REGULATION (EU) N° 813/2013/EU of 2 August 2013.

# Operating Maps

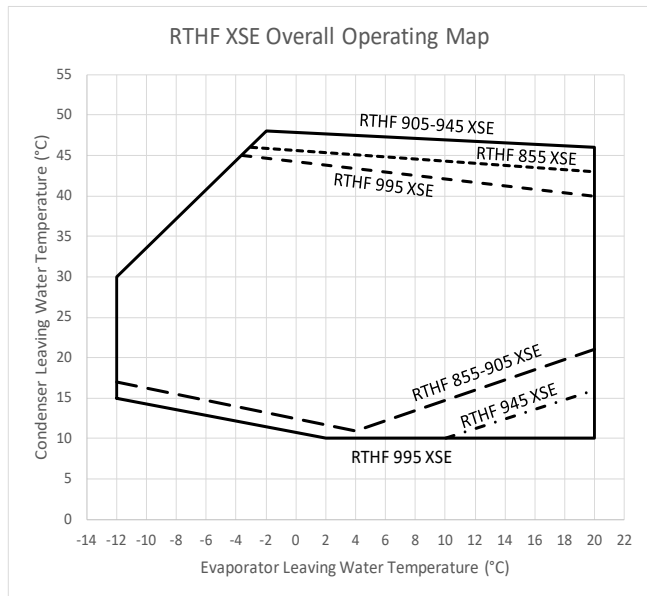
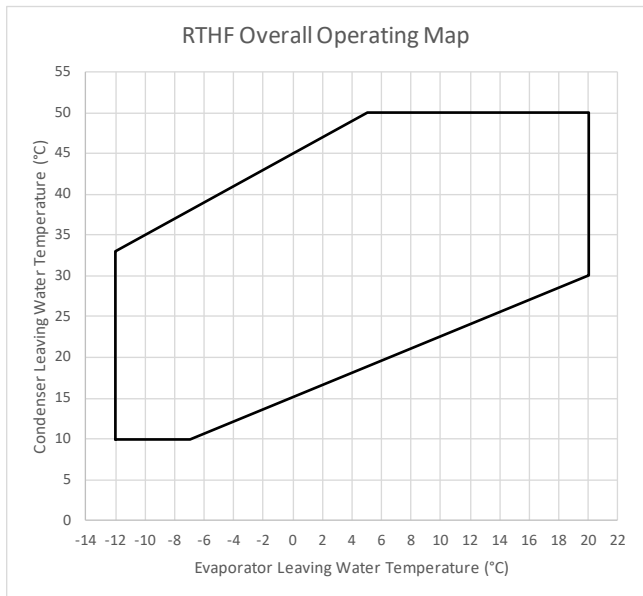
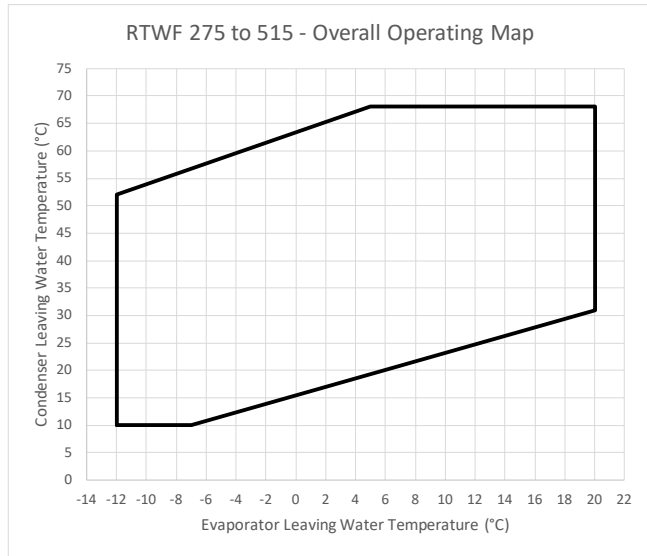
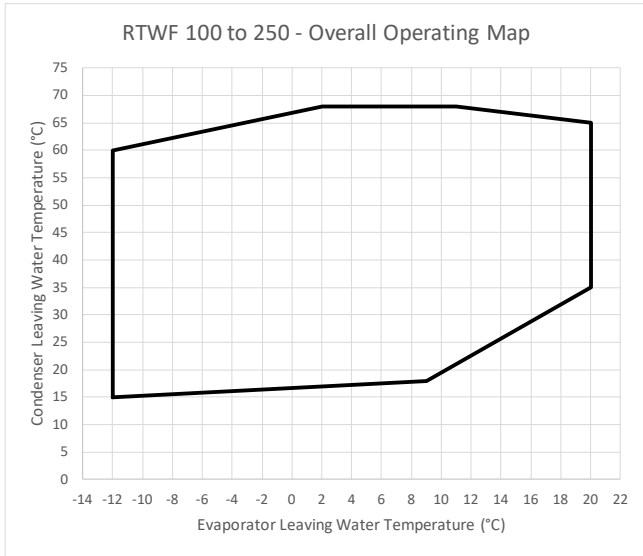

The charts above represent the overall operating limits of the unit, that is to say the limits within which unit will remain in operation. Some capacity limitations may occur depending on model and size when getting close to those limits. Always refer to Trane Official Product Selection Software output for actual operation limits of the selected unit.

# Pressure drop

## Evaporator pressure drop

RTWF 100 to 230 SE - Evaporator pressure drop

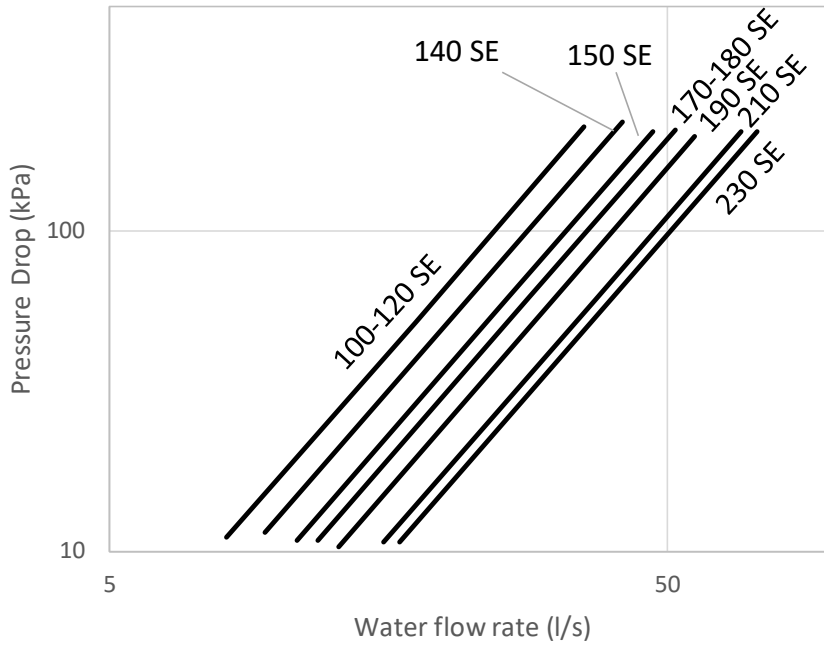

RTWF 275 to 490 SE - Evaporator pressure drop

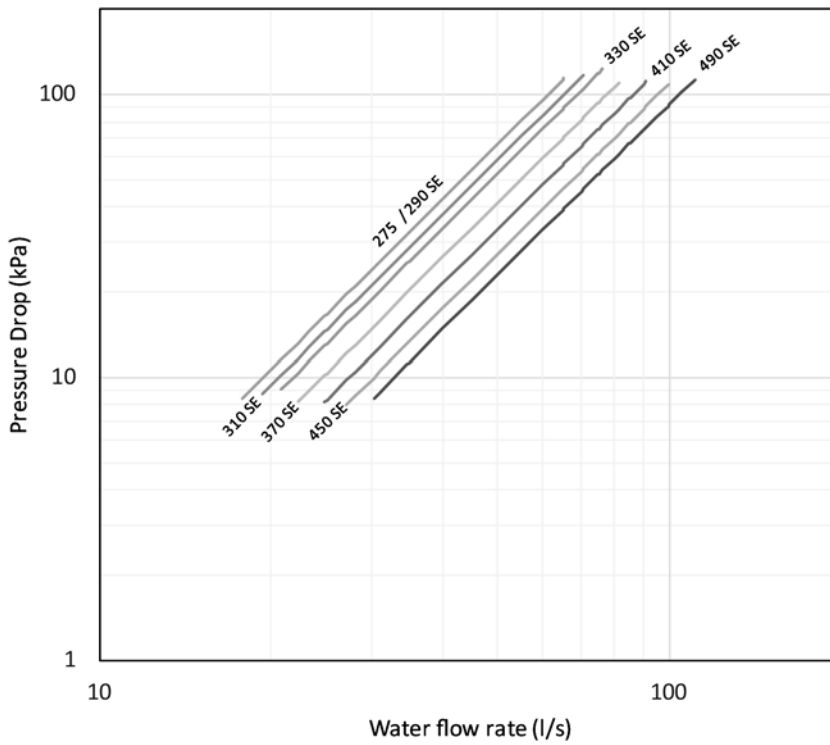

## Pressure drop

RTWF 100 to 250 HE/HSE - Evaporator pressure drop

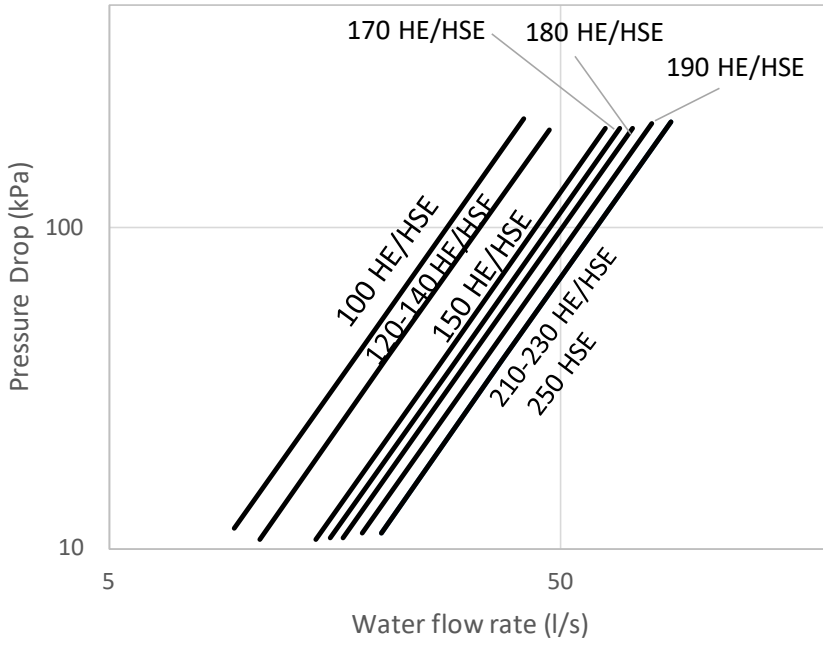

RTWF 275 to 515 HE/HSE - Evaporator pressure drop

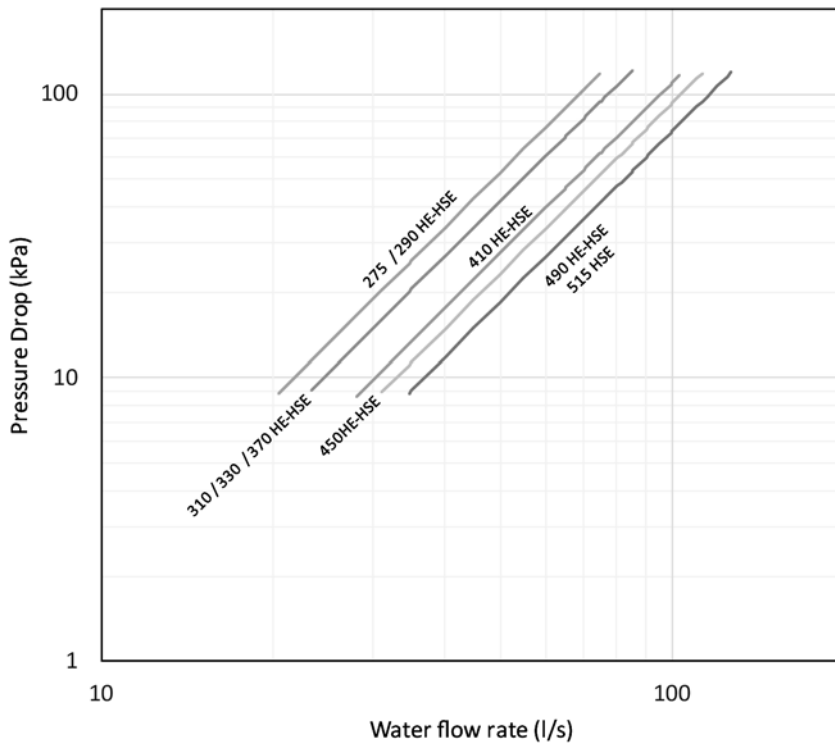

## Pressure drop

### RTHF XE/HSE/XSE - Evaporator pressure drop

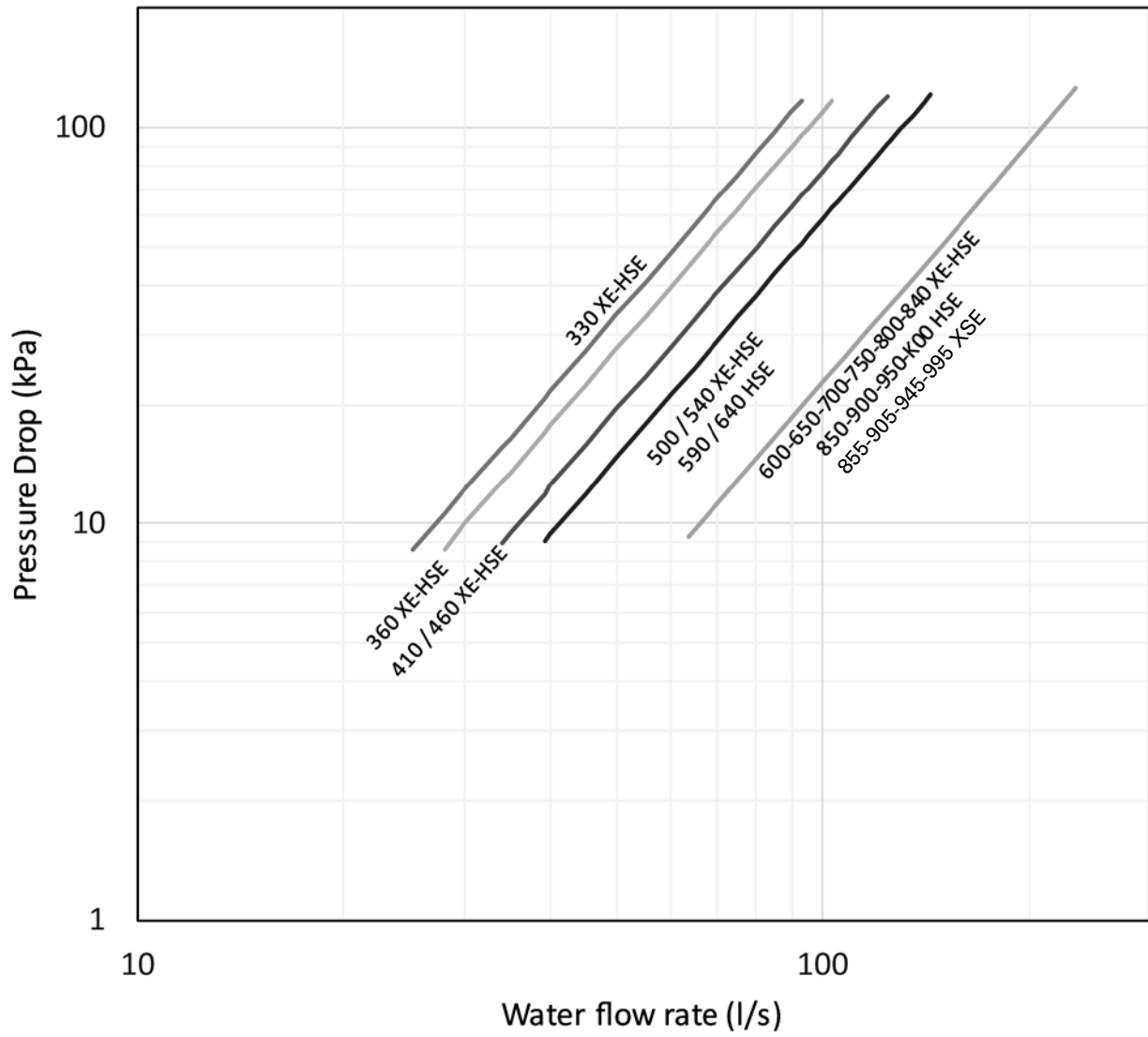

## Pressure drop

### Condenser pressure drop

RTWF 100 to 230 SE

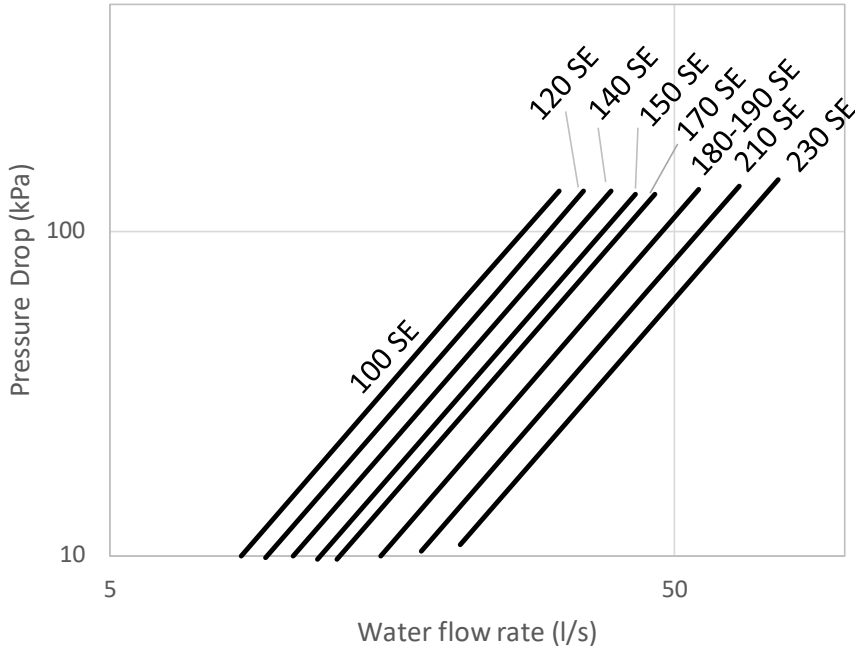

RTWF 275 to 490 SE - Condenser pressure drop

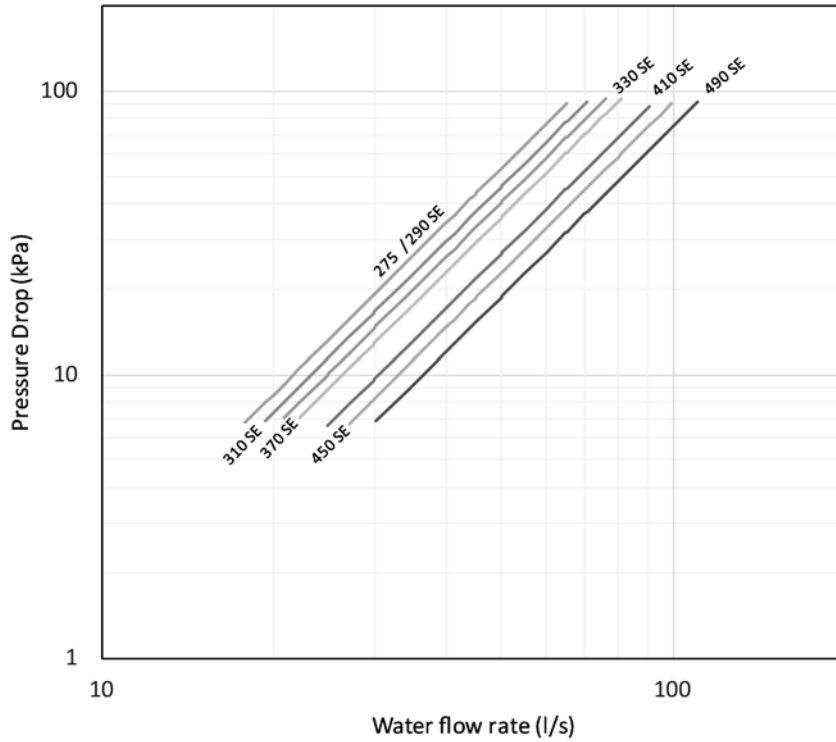

## Pressure drop

RTWF 100 to 250 HE/HSE - Condenser pressure drop

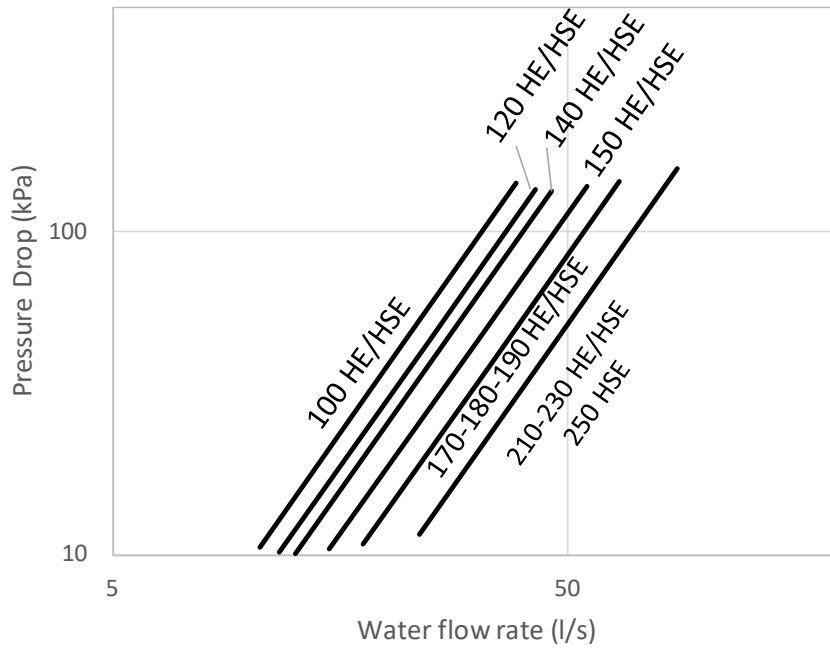

RTWF 275 to 515 HE/HSE - Condenser pressure drop

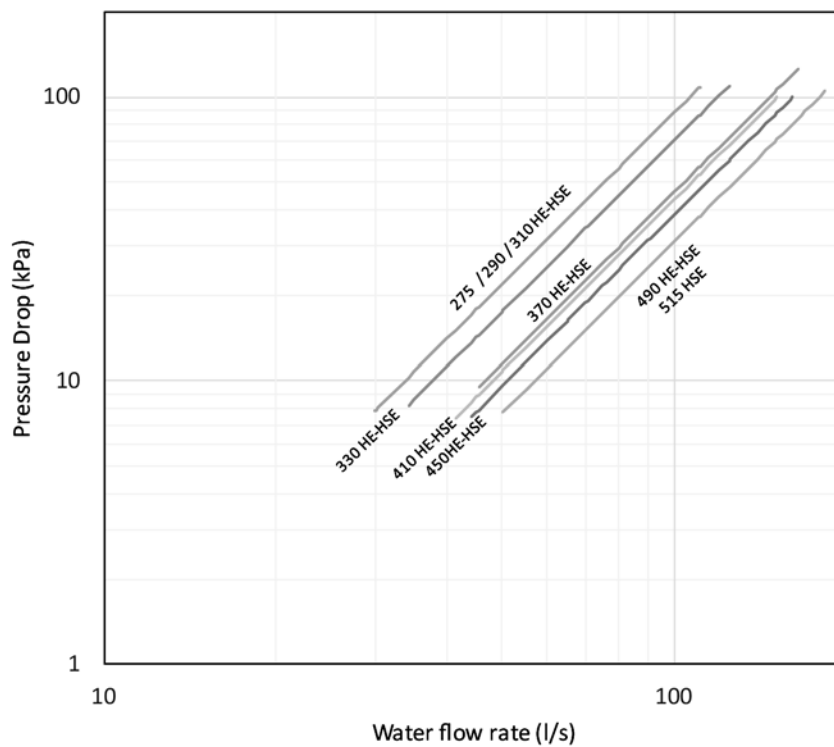

## Pressure drop

### RTHF XE/HSE/XSE - Condenser pressure drop

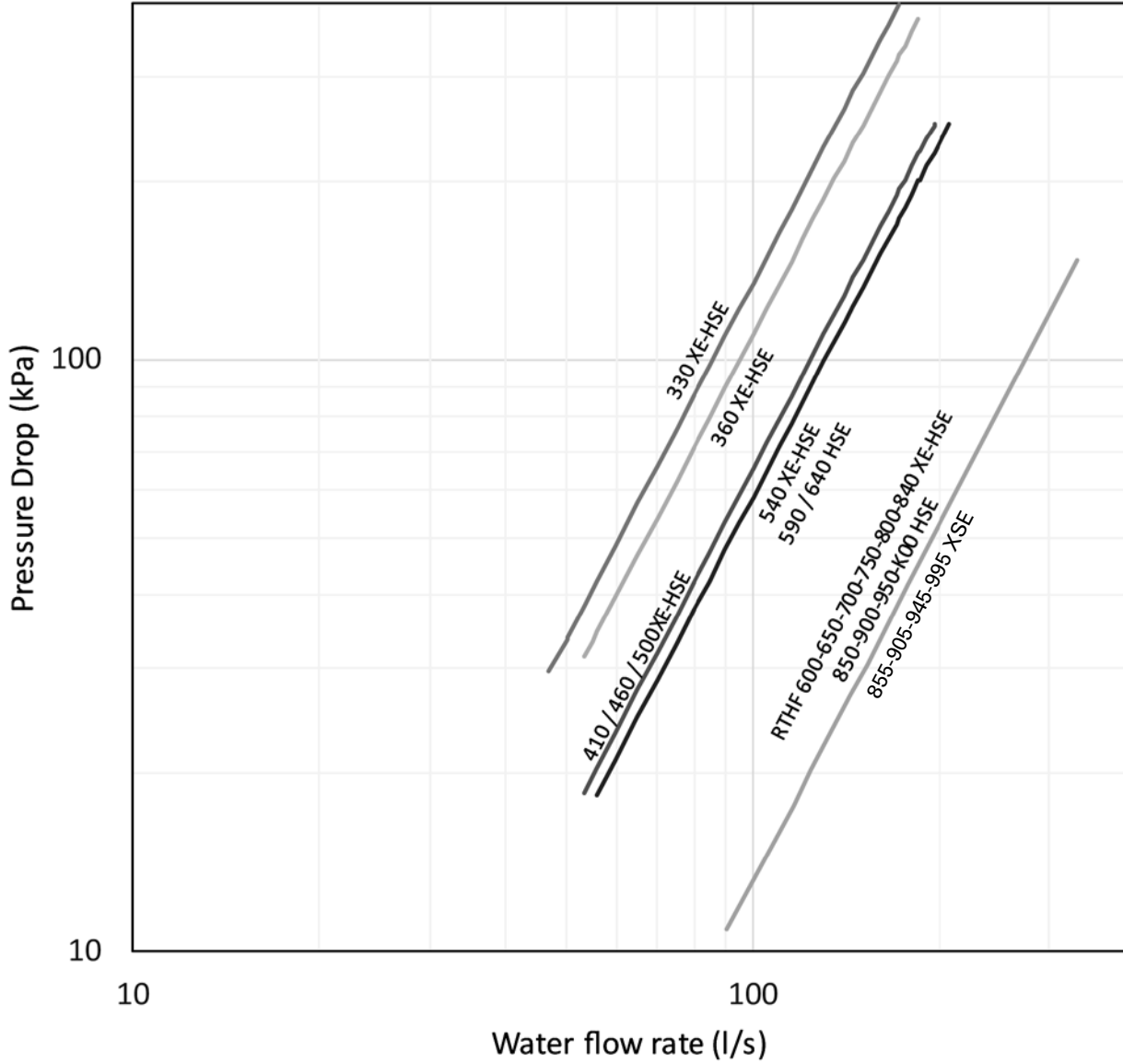



# Electrical Data

RTWF SE (Standard Efficiency) R134a			RTWF 100 SE	RTWF 120 SE	RTWF 140 SE	RTWF 150 SE	RTWF 170 SE	RTWF 180 SE	RTWF 190 SE	RTWF 210 SE	RTWF 230 SE
Std application	Max current	(A)	162	190	223	243	263	290	318	348	378
	Starting current	(A)	224	274	327	347	389	417	449	479	542
High condensing application	Max current	(A)	197	235	285	310	335	370	405	444	483
	Starting current	(A)	241	296	358	383	425	460	492	531	594

RTWF SE (Standard Efficiency) R134a			RTWF 275 SE	RTWF 290 SE	RTWF 310 SE	RTWF 330 SE	RTWF 370 SE	RTWF 410 SE	RTWF 450 SE	RTWF 490 SE
Std application	Max current	(A)	402	418	442	472	532	588	648	708
	Starting current	(A)	547	563	587	650	710	733	826	886
High condensing application	Max current	(A)	546	571	606	645	723	807	885	963
	Starting current	(A)	636	664	696	759	837	897	999	1077

RTWF HE (High Efficiency) R134a			RTWF 100 HE	RTWF 120 HE	RTWF 140 HE	RTWF 150 HE	RTWF 170 HE	RTWF 180 HE	RTWF 190 HE	RTWF 210 HE	RTWF 230 HE
Std application	Max current	(A)	162	190	223	243	263	290	318	348	378
	Starting current	(A)	224	274	327	347	389	417	449	479	542
High condensing application	Max current	(A)	197	235	285	310	335	370	405	444	483
	Starting current	(A)	241	296	358	383	425	460	492	531	594

RTWF HE (High Efficiency) R134a			RTWF 275 HE	RTWF 290 HE	RTWF 310 HE	RTWF 330 HE	RTWF 370 HE	RTWF 410 HE	RTWF 450 HE	RTWF 490 HE
Std application	Max current	(A)	402	418	442	472	532	588	648	708
	Starting current	(A)	547	563	587	650	710	733	826	886
High condensing application	Max current	(A)	546	571	606	645	723	807	885	963
	Starting current	(A)	636	664	696	759	837	897	999	1077

RTWF HSE (High Seasonal Efficiency) R134a			RTWF 100 HSE	RTWF 120 HSE	RTWF 140 HSE	RTWF 150 HSE	RTWF 170 HSE	RTWF 180 HSE	RTWF 190 HSE	RTWF 210 HSE	RTWF 230 HSE	RTWF 250 HSE
Std application	Max current	(A)	160	184	214	232	251	281	309	334	363	406
	Starting current	(A)	221	267	318	336	378	408	440	464	527	569
High condensing application	Max current	(A)	193	228	273	297	322	357	392	429	468	510
	Starting current	(A)	237	290	346	370	412	447	479	516	579	622

RTWF HSE (High Seasonal Efficiency) R134a			RTWF 275 HSE	RTWF 290 HSE	RTWF 310 HSE	RTWF 330 HSE	RTWF 370 HSE	RTWF 410 HSE	RTWF 450 HSE	RTWF 490 HSE	RTWF 515 HSE
Std application	Max current	(A)	384	401	422	452	511	569	629	688	753
	Starting current	(A)	529	546	567	630	689	714	807	866	931
High condensing application	Max current	(A)	521	546	580	619	690	781	859	930	960
	Starting current	(A)	611	636	670	733	804	871	973	1044	1074



## Electrical Data

<b>RTWF SE (Standard Efficiency) R513A</b>			<b>RTWF 100 SE</b>	<b>RTWF 120 SE</b>	<b>RTWF 140 SE</b>	<b>RTWF 150 SE</b>	<b>RTWF 170 SE</b>	<b>RTWF 180 SE</b>	<b>RTWF 190 SE</b>	<b>RTWF 210 SE</b>	<b>RTWF 230 SE</b>
Std application	Max current	(A)	162	190	223	243	263	290	318	348	378
	Starting current	(A)	224	274	327	347	389	417	449	479	542
High condensing application	Max current	(A)	197	235	285	310	335	370	405	444	483
	Starting current	(A)	241	296	358	383	425	460	492	531	594

<b>RTWF (HE High Efficiency) R513A</b>			<b>RTWF 100 HE</b>	<b>RTWF 120 HE</b>	<b>RTWF 140 HE</b>	<b>RTWF 150 HE</b>	<b>RTWF 170 HE</b>	<b>RTWF 180 HE</b>	<b>RTWF 190 HE</b>	<b>RTWF 210 HE</b>	<b>RTWF 230 HE</b>
Std application	Max current	(A)	162	190	223	243	263	290	318	348	378
	Starting current	(A)	224	274	327	347	389	417	449	479	542
High condensing application	Max current	(A)	197	235	285	310	335	370	405	444	483
	Starting current	(A)	241	296	358	383	425	460	492	531	594

<b>RTHF XE (Extra High Efficiency) R134a</b>			<b>RTHF 330 XE</b>	<b>RTHF 360 XE</b>	<b>RTHF 410 XE</b>	<b>RTHF 460 XE</b>	<b>RTHF 500 XE</b>	<b>RTHF 540 XE</b>
Std application	Max current	(A)	468	466	583	582	698	698
	Starting current	(A)	647	645	762	761	829	829

<b>RTHF XE (Extra High Efficiency) R134a</b>			<b>RTHF 600 XE</b>	<b>RTHF 650 XE</b>	<b>RTHF 700 XE</b>	<b>RTHF 750 XE</b>	<b>RTHF 800 XE</b>	<b>RTHF 840 XE</b>
Std application	Max current	(A)	804	910	910	910	943	976
	Starting current	(A)	1097	1203	1203	1203	1236	1236

<b>RTHF HSE (High Seasonal Efficiency) R134a</b>			<b>RTHF 330 HSE</b>	<b>RTHF 360 HSE</b>	<b>RTHF 410 HSE</b>	<b>RTHF 460 HSE</b>	<b>RTHF 500 HSE</b>	<b>RTHF 540 HSE</b>	<b>RTHF 590 HSE</b>	<b>RTHF 640 HSE</b>	<b>RTHF 600 HSE</b>
Std application	Max current	(A)	429	428	527	527	627	627	708	773	726
	Starting current	(A)	429	428	527	527	627	627	708	773	726

<b>RTHF HSE (High Seasonal Efficiency) R134a</b>			<b>RTHF 650 HSE</b>	<b>RTHF 700 HSE</b>	<b>RTHF 750 HSE</b>	<b>RTHF 800 HSE</b>	<b>RTHF 840 HSE</b>	<b>RTHF 850 HSE</b>	<b>RTHF 900 HSE</b>	<b>RTHF 950 HSE</b>	<b>RTHF K00 HSE</b>
Std application	Max current	(A)	825	825	827	859	892	1360	1360	1360	1360
	Starting current	(A)	825	825	827	859	892	1360	1360	1360	1360

<b>RTHF XSE (Extra High Seasonal Efficiency) R134a</b>			<b>RTHF 855 XSE</b>	<b>RTHF 905 XSE</b>	<b>RTHF 945 XSE</b>	<b>RTHF 995 XSE</b>
Std application	Max current	(A)	1369	1369	1369	1369
	Starting current	(A)	1369	1369	1369	1369

# Acoustic Data

		Global Sound Power SWL (dB(A))	Global Sound Pressure level at 10m SPL (dB(A))
RTWF 100 SE	R134a	99	67
RTWF 120 SE	R134a	99	67
RTWF 140 SE	R134a	96	64
RTWF 150 SE	R134a	96	64
RTWF 170 SE	R134a	96	64
RTWF 180 SE	R134a	99	67
RTWF 190 SE	R134a	101	69
RTWF 210 SE	R134a	101	69
RTWF 230 SE	R134a	101	69
RTWF 275 SE	R134a	100	68
RTWF 290 SE	R134a	100	68
RTWF 310 SE	R134a	101	69
RTWF 330 SE	R134a	101	69
RTWF 370 SE	R134a	101	69
RTWF 410 SE	R134a	102	70
RTWF 450 SE	R134a	102	70
RTWF 490 SE	R134a	102	70
RTWF 100 HE	R134a	99	67
RTWF 120 HE	R134a	99	67
RTWF 140 HE	R134a	96	64
RTWF 150 HE	R134a	96	64
RTWF 170 HE	R134a	96	64
RTWF 180 HE	R134a	99	67
RTWF 190 HE	R134a	101	69
RTWF 210 HE	R134a	101	69
RTWF 230 HE	R134a	101	69
RTWF 275 HE	R134a	100	68
RTWF 290 HE	R134a	100	68
RTWF 310 HE	R134a	101	69
RTWF 330 HE	R134a	101	69
RTWF 370 HE	R134a	101	69
RTWF 410 HE	R134a	102	70
RTWF 450 HE	R134a	102	70
RTWF 490 HE	R134a	102	70
RTWF 100 HSE	R134a	99	67
RTWF 120 HSE	R134a	99	67
RTWF 140 HSE	R134a	96	64
RTWF 150 HSE	R134a	96	64
RTWF 170 HSE	R134a	96	64
RTWF 180 HSE	R134a	99	67
RTWF 190 HSE	R134a	101	69
RTWF 210 HSE	R134a	101	69
RTWF 230 HSE	R134a	101	69
RTWF 250 HSE	R134a	103	71
RTWF 275 HSE	R134a	100	68
RTWF 290 HSE	R134a	100	68
RTWF 310 HSE	R134a	101	69
RTWF 330 HSE	R134a	101	69
RTWF 370 HSE	R134a	101	69
RTWF 410 HSE	R134a	102	70
RTWF 450 HSE	R134a	102	70
RTWF 490 HSE	R134a	102	70
RTWF 515 HSE	R134a	107	75
RTWF 100 SE	R513A	99	67
RTWF 120 SE	R513A	99	67
RTWF 140 SE	R513A	96	64
RTWF 150 SE	R513A	96	64
RTWF 170 SE	R513A	96	64
RTWF 180 SE	R513A	99	67
RTWF 190 SE	R513A	101	69
RTWF 210 SE	R513A	101	69
RTWF 230 SE	R513A	101	69
RTWF 100 HE	R513A	99	67
RTWF 120 HE	R513A	99	67
RTWF 140 HE	R513A	96	64
RTWF 150 HE	R513A	96	64
RTWF 170 HE	R513A	96	64
RTWF 180 HE	R513A	99	67
RTWF 190 HE	R513A	101	69
RTWF 210 HE	R513A	101	69
RTWF 230 HE	R513A	101	69

## Acoustic Data

	Global Sound Power SWL (dB(A))	Global Sound Pressure level at 10m SPL (dB(A))
RTHF 330 XE	97	65
RTHF 360 XE	97	65
RTHF 410 XE	98	66
RTHF 460 XE	98	66
RTHF 500 XE	99	67
RTHF 540 XE	99	67
RTHF 600 XE	102	70
RTHF 650 XE	103	71
RTHF 700 XE	103	71
RTHF 750 XE	103	71
RTHF 800 XE	103	71
RTHF 840 XE	103	71
RTHF 330 HSE	97	65
RTHF 360 HSE	97	65
RTHF 410 HSE	98	66
RTHF 460 HSE	98	66
RTHF 500 HSE	99	67
RTHF 540 HSE	99	67
RTHF 590 HSE	102	70
RTHF 640 HSE	104	72
RTHF 600 HSE	102	70
RTHF 650 HSE	103	71
RTHF 700 HSE	103	71
RTHF 750 HSE	103	71
RTHF 800 HSE	103	71
RTHF 840 HSE	103	71
RTHF 850 HSE	103	71
RTHF 900 HSE	106	74
RTHF 950 HSE	107	75
RTHF K00 HSE	109	77
RTHF 855 XSE	103	71
RTHF 905 XSE	109	77
RTHF 945 XSE	110	78
RTHF 995 XSE	111	79



# Notes



## Notes



## Notes

Trane - by Trane Technologies (NYSE: TT), a global climate innovator - creates comfortable, energy efficient indoor environments for commercial and residential applications. For more information, please visit [trane.com](http://trane.com) or [tranetechnologies.com](http://tranetechnologies.com).

Trane has a policy of continuous product and product data improvement and reserves the right to change design and specifications without notice. We are committed to using environmentally conscious print practices.

RLC-PRC058F-GB April 2020  
Supersedes RLC-PRC058E-GB (July 2019)

© 2020 Trane

Confidential and proprietary Trane information