



R410A

Commercial Air Conditioners

Service Manual



4TVR0086EE000AA

4TVR0155EE000AA

4TVR0096EE000AA

4TVR0170EE000AA

4TVR0115EE000AA

4TVR0192EE000AA

4TVR0140EE000AA

CONTENTS

Part 1 General Information	3
Part 2 Component Layout and Refrigerant Circuits.....	13
Part 3 Control.....	25
Part 4 Field Settings	51
Part 5 Electrical Components and Wiring Diagrams.....	57
Part 6 Diagnosis and Troubleshooting.....	83

Part 1

General Information

1 Indoor and Outdoor Unit Capacities.....	4
2 External Appearance	5
3 Outdoor Unit Combinations.....	10
4 Combination Ratio	11

1 Indoor and Outdoor Unit Capacities

1.1 Indoor Units

1.1.1 TVR indoor units

Table 1-1.1: Standard indoor unit abbreviation codes

Abbreviation code	Type
Q1	One-way Cassette
Q2	Two-way Cassette
Q4C	Compact Four-way Cassette
Q4	Four-way Cassette
T2	Medium Static Pressure Duct

Abbreviation code	Type
T1	High Static Pressure Duct
G	Wall-mounted
DL	Ceiling & Floor
F	Floor Standing

Table 1-1.2: Indoor unit capacity range

Capacity			Capacity index	Q1	Q2	Q4C	Q4	T2	T1	G	DL	F
kW	kBtu/h	HP										
1.8	5	0.6	18	18	—	—	—	—	—	—	—	—
2.2	7	0.8	22	22	22	22	—	22	—	22	—	22
2.8	9	1	28	28	28	28	28	28	—	28	—	28
3.6	12	1.25	36	36	36	36	36	36	—	36	36	36
4.5	15	1.6	45	45	45	45	45	45	—	45	45	45
5.6	19	2	56	56	56	—	56	56	—	56	56	56
7.1	24	2.5	71	71	71	—	71	71	71	71	71	71
8.0	27	3	80	—	—	—	80	80	80	80	80	80
9.0	30	3.2	90	—	—	—	90	90	90	90	90	—
10.0	34	3.6	100	—	—	—	100	—	—	—	—	—
11.2	38	4	112	—	—	—	112	112	112	—	112	—
14.0	48	5	140	—	—	—	140	140	140	—	140	—
16.0	55	6	160	—	—	—	160	160	160	—	160	—
20.0	68	7	200	—	—	—	—	—	200	—	—	—
25.0	85	9	250	—	—	—	—	—	250	—	—	—
28.0	96	10	280	—	—	—	—	—	280	—	—	—

Notes:

1. TVR ULTRA HR series outdoor units are compatible with the 2nd generation DC TVR indoor unit and 2nd generation AC TVR indoor units (which will be released soon).

1.1.2 Fresh air processing unit

Table 1-1.3: Fresh air processing unit capacity range

Capacity	12.5kW	14kW	20kW	25kW	28kW
Capacity index	125	140	200	250	280

Notes:

1. TVR ULTRA HR series outdoor units are compatible with the 2nd generation DC Fresh air processing unit.

1.2 Heat recovery ventilator

Table 1-1.4: Heat recovery ventilator capacity range

Capacity	200m ³ /h	300m ³ /h	400m ³ /h	500m ³ /h	800m ³ /h	1000m ³ /h	1500m ³ /h	2000m ³ /h
----------	----------------------	----------------------	----------------------	----------------------	----------------------	-----------------------	-----------------------	-----------------------

Notes:

1. TVR ULTRA HR series outdoor units are compatible with the DC type heat recovery ventilator.

1.3 High Temperature Hydro Module

Table 1-1.5: 1.3 High Temperature Hydro Module capacity range

Capacity	14kW
Capacity index	140

1.4 Outdoor Units

Table 1-1.6: Outdoor unit capacity range

Capacity	Model Name	Combination Type
8HP	4TVR0086EE000AA	/
10HP	4TVR0096EE000AA	/
12HP	4TVR0115EE000AA	/
14HP	4TVR0140EE000AA	/
16HP	4TVR0155EE000AA	/
18HP	4TVR0170EE000AA	/
20HP	4TVR0192EE000AA	/
22HP	4TVR0210EE000AA	12HP+10HP
24HP	4TVR0232EE000AA	14HP+10HP
26HP	4TVR0250EE000AA	14HP+12HP
28HP	4TVR0268EE000AA	16HP+12HP
30HP	4TVR0285EE000AA	18HP+12HP
32HP	4TVR0308EE000AA	16HP+16HP
34HP	4TVR0325EE000AA	18HP+16HP
36HP	4TVR0342EE000AA	18HP+18HP
38HP	4TVR0362EE000AA	20HP+18HP
40HP	4TVR0382EE000AA	20HP+20HP
42HP	4TVR0404EE000AA	16HP+14HP+12HP
44HP	4TVR0422EE000AA	16HP+16HP+12HP
46HP	4TVR0444EE000AA	16HP+16HP+14HP
48HP	4TVR0462EE000AA	16HP+16HP+16HP
50HP	4TVR0479EE000AA	18HP+16HP+16HP
52HP	4TVR0496EE000AA	18HP+18HP+16HP
54HP	4TVR0513EE000AA	18HP+18HP+18HP
56HP	4TVR0533EE000AA	20HP+18HP+18HP
58HP	4TVR0553EE000AA	20HP+20HP+18HP
60HP	4TVR0573EE000AA	20HP+20HP+20HP









Notes:

1. The combinations of units shown in the table are factory-recommended. Other combinations of units are also possible.

2 External Appearance

2.1 Indoor Units

Table 1-2.1: Indoor unit appearance

One-way Cassette Q1 	Two-way Cassette Q2 
Compact Four-way Cassette Q4C 	Four-way Cassette Q4 
Medium Static Pressure Duct T2 	High Static Pressure Duct T1 
Wall-mounted G 	Ceiling & Floor DL 
Floor Standing F 	

2.1.1 Fresh air processing unit

Table 1-2.2: Fresh air processing unit appearance

Fresh Air Processing Unit FA 
--

2.2 Heat Recovery Ventilator

Table 1-2.3: Heat recovery ventilator appearance

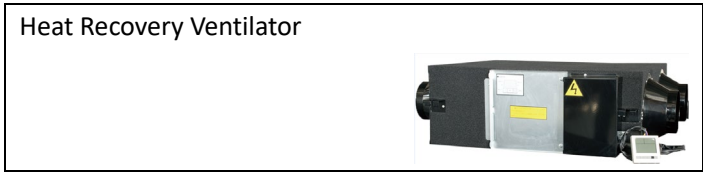

2.3 High Temperature Hydro Module



Table 1-2.4: High temperature Hydro module appearance



2.4 Outdoor Units





2.4.1 Single units

Table 1-2.5: Single outdoor unit appearance







8/10/12HP (with single fan)	14/16/18/20HP (with dual fan)
	

2.4.2 Combinations of units

Table 1-2.6: Combination outdoor unit appearance

<p data-bbox="432 846 496 875">22HP</p> 	<p data-bbox="1018 846 1203 875">24/26/28/30HP</p> 
<p data-bbox="352 1225 576 1254">32/34/36/38/40HP</p> 	<p data-bbox="1054 1225 1160 1254">42/44HP</p> 
<p data-bbox="624 1601 971 1630">46/48/50/52/54/56/58/60HP</p> 	

2.5 Mode Selection Box
Table 1-2.7: MS box appearance

Model name	Appearance	Max. number of downstream indoor units
TMSBOX01E ^{1,2}		8
TMSBOX04E		20
TMSBOX06E		30
TMSBOX08E		40
TMSBOX10E		47
TMSBOX12E		47

Notes:

1. TMSBOX01E can be ceiling-suspended installed and wall-mounted installed.
2. Low temperature cooling operation and leakage detection function are available in TMSBOX01E.

3 Outdoor Unit Combinations

Table 1-3.1: Outdoor unit combinations

System capacity		Number of units	Modules ¹							Outdoor branch joint kit ²
kW	HP		8	10	12	14	16	18	20	
22.4	8	1	•							—
28.0	10	1		•						
33.5	12	1			•					
40.0	14	1				•				
45.0	16	1					•			
50.0	18	1						•		
56.0	20	1							•	
61.5	22	2		•	•					TODK002HRU
68.0	24	2		•		•				
73.5	26	2			•	•				
78.5	28	2			•		•			
83.5	30	2			•			•		
90.0	32	2					••			
95.0	34	2					•	•		
100.0	36	2						••		
106.0	38	2						•	•	
112.0	40	2							••	
118.5	42	3			•	•	•			TODK003HRU
123.5	44	3			•		••			
130.0	46	3				•	••			
135.0	48	3					•••			
140.0	50	3					••	•		
145.0	52	3					•	••		
150.0	54	3						•••		
156.0	56	3						••	•	
162.0	58	3						•	••	
168.0	60	3							•••	

Notes:

1. The combinations of units shown in the table are factory-recommended. Other combinations of units are also possible.
2. For systems with two or more outdoor units, outdoor branch joints (sold separately) are required.

4 Combination Ratio

$$\text{Combination ratio} = \frac{\text{Sum of capacity indexes of the indoor units}}{\text{Capacity index of the outdoor units}}$$

Table 1-4.1: Indoor and outdoor unit combination ratio limitations

Type	Total combination ratio	Allowed combination ratio			
		TVR indoor units ¹	HT hydro module	AHU	Fresh air processing units
TVR indoor units only	50%~200% (Single) 50%~150% (2 units combination) 50%~130% (3 units combination)	50%~200% (Single) 50%~150% (2 units combination) 50%~130% (3 units combination)	/	/	/
TVR indoor units + HT hydro module units	50%~200%	50%~130%	0%~100% ²	/	/
TVR indoor units + AHUs	50%~100%	50%~100%	/	0%~50% ³	/
TVR indoor units + fresh air processing units	50%~100%	50%~100%	/	/	0%~30% ³
Fresh air processing units only	50%~100%	/	/	/	50%~100%

Notes:

1. TVR ULTRA HR series outdoor units are compatible with the 2nd generation DC TVR indoor unit and 2nd generation AC TVR indoor units (which will be released soon).
2. When HT hydro module units are installed together with TVR indoor units, the total capacity of HT hydro module units must not exceed 100% of the total capacity of the outdoor units and the combination ratio must not exceed 200%.
3. When AHUs are installed together with TVR indoor units, the total capacity of AHUs must not exceed 50% of the total capacity of the outdoor units and the combination ratio must not exceed 100%.
4. When fresh air processing units are installed together with TVR indoor units, the total capacity of the fresh air processing units must not exceed 30% of the total capacity of the outdoor units and the combination ratio must not exceed 100%.
5. HT hydro module units only and AHUs only are not allowed.

Table 1-4.2: Combinations of indoor and outdoor units

Outdoor unit capacity			Sum of capacity indexes				Maximum number of connected indoor units ¹
kW	HP	Capacity index	TVR indoor units only	TVR indoor units + HT hydro module	TVR indoor units + AHUs	TVR indoor units + fresh air processing units	
22.4	8	224	112 to 291.2	112 to 448	112 to 224	112 to 224	64
28	10	280	140 to 364	140 to 560	140 to 280	140 to 280	
33.5	12	335	167.5 to 435.5	167.5 to 670	167.5 to 335	167.5 to 335	
40	14	400	200 to 520	200 to 800	200 to 400	200 to 400	
45	16	450	225 to 585	225 to 900	225 to 450	225 to 450	
50	18	500	250 to 650	250 to 1000	250 to 500	250 to 500	
56	20	560	280 to 728	280 to 1120	280 to 560	280 to 560	
61.5	22	615	307.5 to 799.5	307.5 to 1230	307.5 to 615	307.5 to 615	
68	24	680	340 to 884	340 to 1360	340 to 680	340 to 680	
73.5	26	735	367.5 to 955.5	367.5 to 1470	367.5 to 735	367.5 to 735	
78.5	28	785	392.5 to 1020.5	392.5 to 1570	392.5 to 785	392.5 to 785	
83.5	30	835	417.5 to 1085.5	417.5 to 1670	417.5 to 835	417.5 to 835	
90	32	900	450 to 1170	450 to 1800	450 to 900	450 to 900	
95	34	950	475 to 1235	475 to 1900	475 to 950	475 to 950	
100	36	1000	500 to 1300	500 to 2000	500 to 1000	500 to 1000	
107	38	1070	535 to 1391	535 to 2140	535 to 1070	535 to 1070	
112	40	1120	560 to 1456	560 to 2240	560 to 1120	560 to 1120	
118.5	42	1185	592.5 to 1540.5	592.5 to 2370	592.5 to 1185	592.5 to 1185	
123.5	44	1235	617.5 to 1605.5	617.5 to 2470	617.5 to 1235	617.5 to 1235	
130	46	1300	650 to 1690	650 to 2600	650 to 1300	650 to 1300	
135	48	1350	675 to 1755	675 to 2700	675 to 1350	675 to 1350	
140	50	1400	700 to 1820	700 to 2800	700 to 1400	700 to 1400	
145	52	1450	725 to 1885	725 to 2900	725 to 1450	725 to 1450	
150	54	1500	750 to 1950	750 to 3000	750 to 1500	750 to 1500	
156	56	1560	780 to 2028	780 to 3120	780 to 1560	780 to 1560	
162	58	1620	810 to 2106	810 to 3240	810 to 1620	810 to 1620	
168	60	1680	840 to 2184	840 to 3360	840 to 1680	840 to 1680	

Notes:

1. The maximum number of connected indoor units depend upon indoor unit type and total combination ratio.

Part 2

Component Layout and Refrigerant Circuits

1	Layout of Functional Components.....	14
2	Piping Diagrams	16
3	Refrigerant Flow Diagrams	19

1 Layout of Functional Components

8/10/12HP

Figure 2-1.1: 8/10/12HP top view

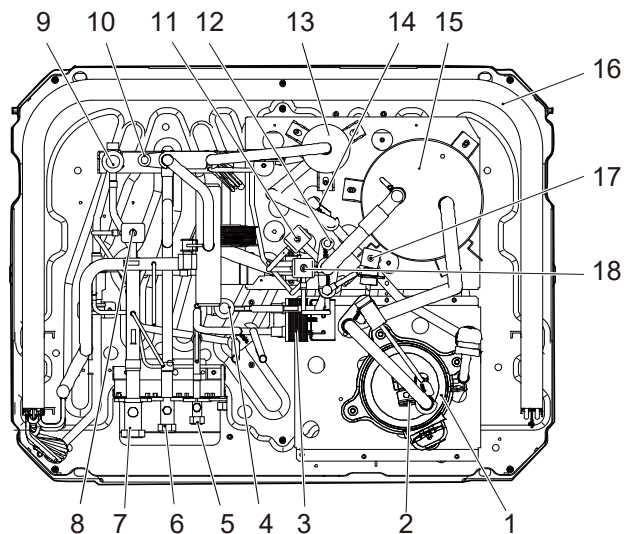
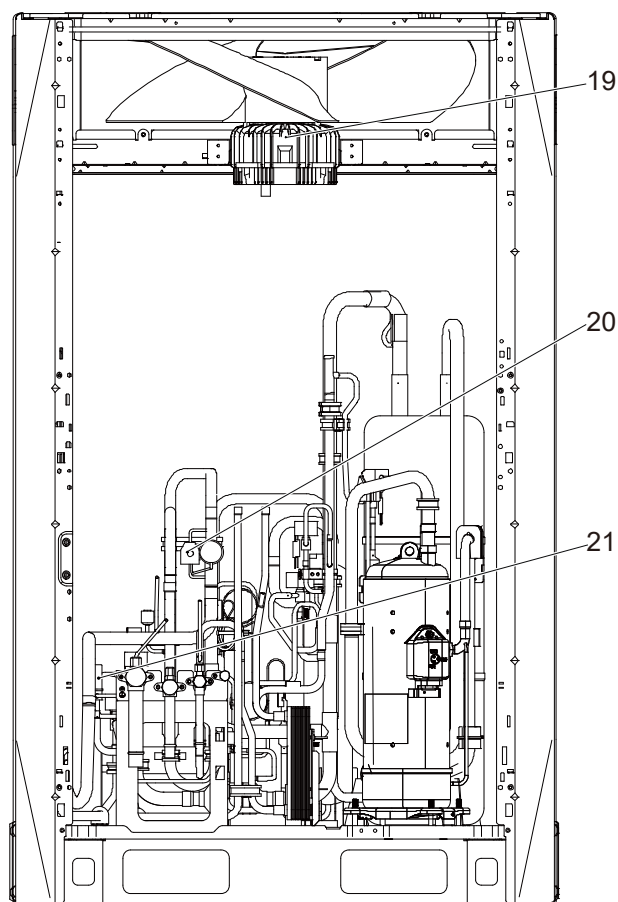

Figure 2-1.2: 8/10/12HP front view



Legend	
No.	Parts name
1	Inverter compressor
2	Discharge temperature switch
3	Plate heat exchanger
4	Electronic expansion valve (EEVC)
5	Stop valve (liquid side)
6	Stop valve (high pressure gas side)
7	Stop valve (low pressure gas side)
8	Refrigerant charge solenoid valve(SVC) (customization option)
9	Electronic expansion valve (EEVA)
10	High pressure sensor
11	Hot gas bypass solenoid valve(SV7)
12	Low pressure sensor
13	Oil separator
14	High pressure switch
15	Gas-liquid separator
16	Heat exchanger
17	Compressor vapor injection valve (SV8A)
18	Injection bypass solenoid valve(SV5)
19	FAN A
20	4-way valve
21	Pressure relief valve (customization option)

14/16/18/20HP

Figure 2-1.3: 14/16/18/20HP top view

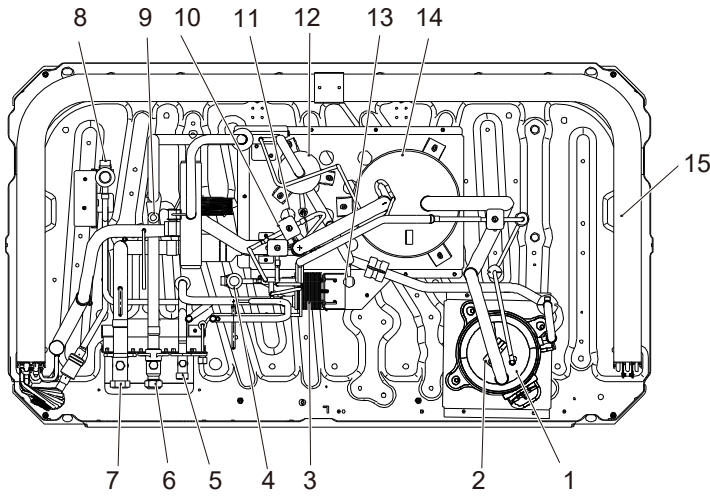
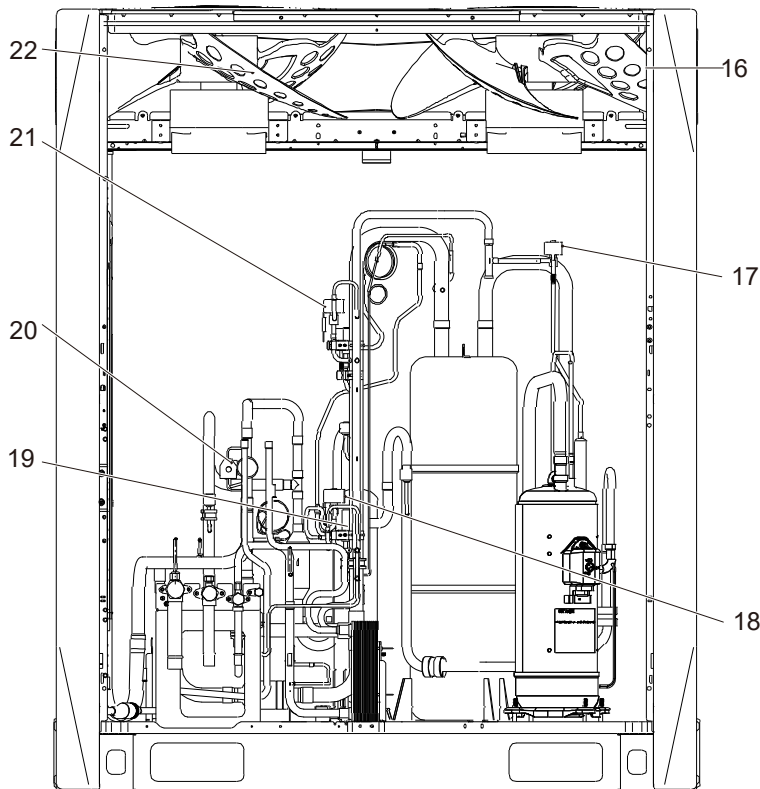

Figure 2-1.4: 14/16/18/20HP front view



Legend	
No.	Parts name
1	Inverter compressor
2	Discharge temperature switch
3	Plate heat exchanger
4	Electronic expansion valve (EEVC)
5	Stop valve (liquid side)
6	Stop valve (high pressure gas side)
7	Stop valve (low pressure gas side)
8	Electronic expansion valve (EEVA)
9	High pressure sensor
10	Hot gas bypass solenoid valve(SV7)
11	Low pressure sensor
12	Oil separator
13	High pressure switch
14	Gas-liquid separator
15	Heat exchanger
16	FAN B
17	Compressor vapor injection valve (SV8A)
18	Refrigerant charge solenoid valve(SVC) (customization option)
19	Pressure relief valve (customization option)
20	4-way valve
21	Injection bypass solenoid valve(SV5)
22	FAN A

2 Piping Diagrams

Figure 2-2.1: 8HP/10HP/12HP piping diagram

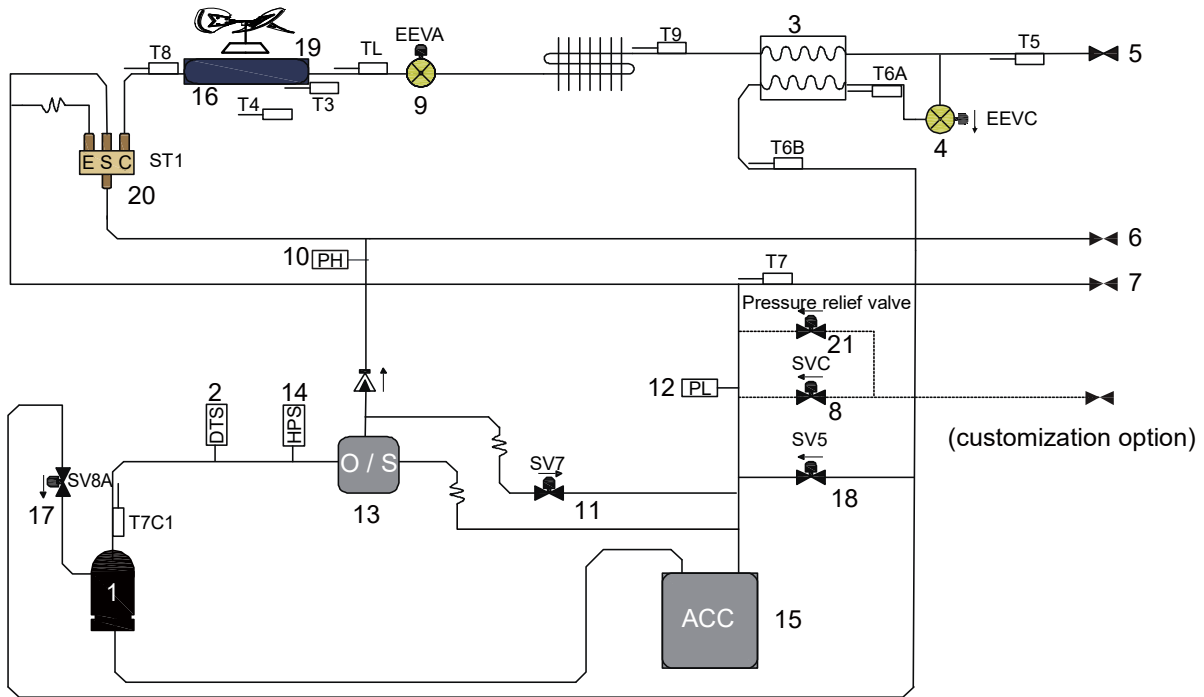

Legend		No.	Parts name
1	Inverter compressor	17	Compressor vapor injection valve (SV8A)
2	Discharge temperature switch	18	Injection bypass solenoid valve(SV5)
3	Plate heat exchanger	19	FAN A
4	Electronic expansion valve (EEVC)	20	4-way valve
5	Stop valve (liquid side)	21	Pressure relief valve (customization option)
6	Stop valve (high pressure gas side)	Sensor Code Description	
7	Stop valve (low pressure gas side)	T3	Heat exchanger deicer temperature sensor
8	Refrigerant charge solenoid valve(SVC) (customization option)	T4	Outdoor air temperature sensor
9	Electronic expansion valve (EEVA)	T5	Liquid pipe temperature sensor
10	High pressure sensor	T6A	Injection liquid temperature sensor
11	Hot gas bypass solenoid valve(SV7)	T6B	Subcooling gas temperature sensor
12	Low pressure sensor	T7	Suction temperature sensor
13	Oil separator	T8	Heat exchanger gas temperature sensor
14	High pressure switch	T9	Heat sink temperature sensor
15	Gas-liquid separator	TL	Heat exchanger liquid temperature sensor
16	Heat exchanger	T7C1	Compressor discharge temperature sensor

Figure 2-2.2: 14HP/16HP/18/20HP piping diagram

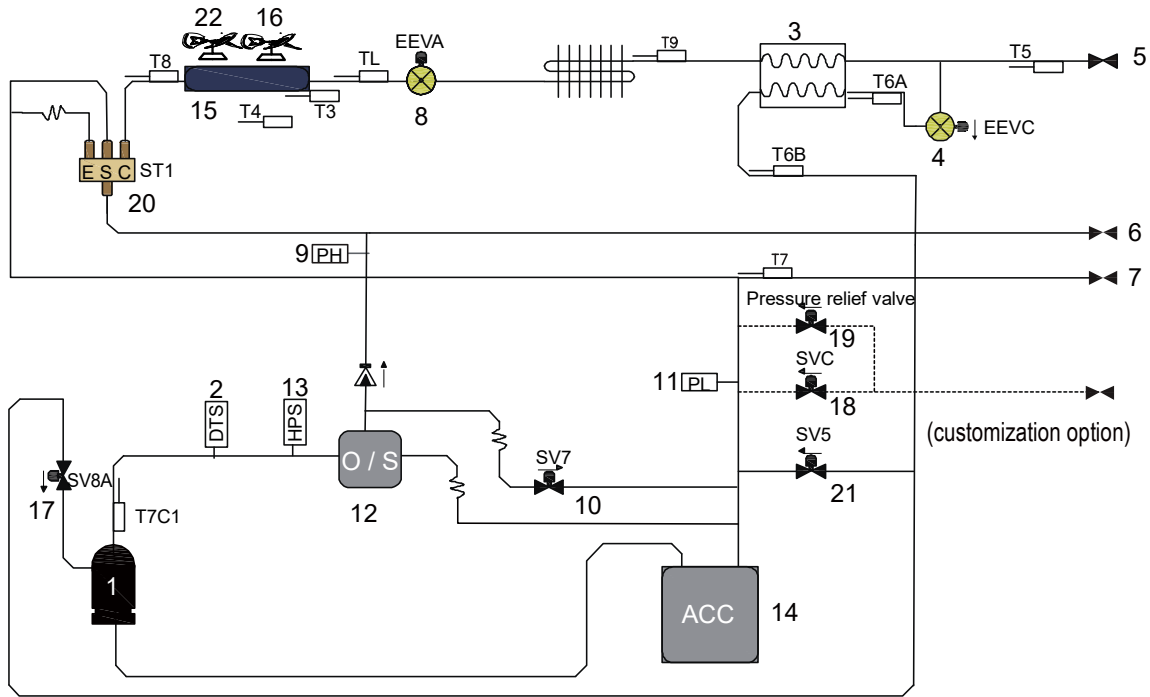

Legend		No.	Parts name
1	Inverter compressor	18	Refrigerant charge solenoid valve(SVC) (customization option)
2	Discharge temperature switch	19	Pressure relief valve (customization option)
3	Plate heat exchanger	20	4-way valve
4	Electronic expansion valve (EEVC)	21	Injection bypass solenoid valve(SV5)
5	Stop valve (liquid side)	22	FAN A
6	Stop valve (high pressure gas side)		Sensor Code Description
7	Stop valve (low pressure gas side)	T3	Heat exchanger deicer temperature sensor
8	Electronic expansion valve (EEVA)	T4	Outdoor air temperature sensor
9	High pressure sensor	T5	Liquid pipe temperature sensor
10	Hot gas bypass solenoid valve(SV7)	T6A	Injection liquid temperature sensor
11	Low pressure sensor	T6B	Subcooling gas temperature sensor
12	Oil separator	T7	Suction temperature sensor
13	High pressure switch	T8	Heat exchanger gas temperature sensor
14	Gas-liquid separator	T9	Heat sink temperature sensor
15	Heat exchanger	TL	Heat exchanger liquid temperature sensor
16	FAN B	T7C1	Compressor discharge temperature sensor
17	Compressor vapor injection valve (SV8A)		

Key components:

- 1. Oil separator:**

Separates oil from gas refrigerant pumped out of the compressor and quickly returns it to the compressor. Separation efficiency is up to 99%.
- 2. Gas-liquid separator:**

Separates liquid refrigerant from gas refrigerant, stores liquid refrigerant and oil to protect compressor from liquid hammering.
- 3. Electronic expansion valve (EEV):**

Controls refrigerant flow and reduces refrigerant pressure.
- 4. Four-way valve:**

Controls heat exchanger function. When open, the heat exchanger functions as an evaporator; When closed, the heat exchanger functions as a condenser. Refer to part 3, "Heat Exchanger Control".
- 5. Plate heat exchanger:**

In cooling mode, it can improve super-cooling degree and the super-cooled refrigerant can achieve better heat exchange in indoor side. In heating mode, the refrigerant comes from the plate heat exchanger going to the compressor can enhance the refrigerant enthalpy and improve the heating capacity in low ambient temperature. Refrigerant volume in plate heat exchanger is controlled according to temperature different between plate heat exchanger inlet and outlet or the temperature different between discharge temperature and target discharge temperature.
- 6. Solenoid valve SV5:**

Controls the refrigerant from plate heat exchanger to gas-liquid separator.
- 7. Solenoid valve SV7:**

Bypass pressure at start-up stage and control capacity at low load condition; High-pressure-rise prevention; Discharge superheat protection.
- 8. Solenoid valve SV8A**

Allows refrigerant from plate heat exchanger inject directly to the compressor. SV8A opens when compressor startup and closes when compressor stop.
- 9. High pressure switch**

Regulate system pressure. When system pressure rises above the upper limit, the high pressure switch turn off, stopping the compressor. When the high pressure protection recovers, the compressor restarts.

3 Refrigerant Flow Diagrams

Cooling operation

Figure 2-3.1: Refrigerant flow during cooling operation

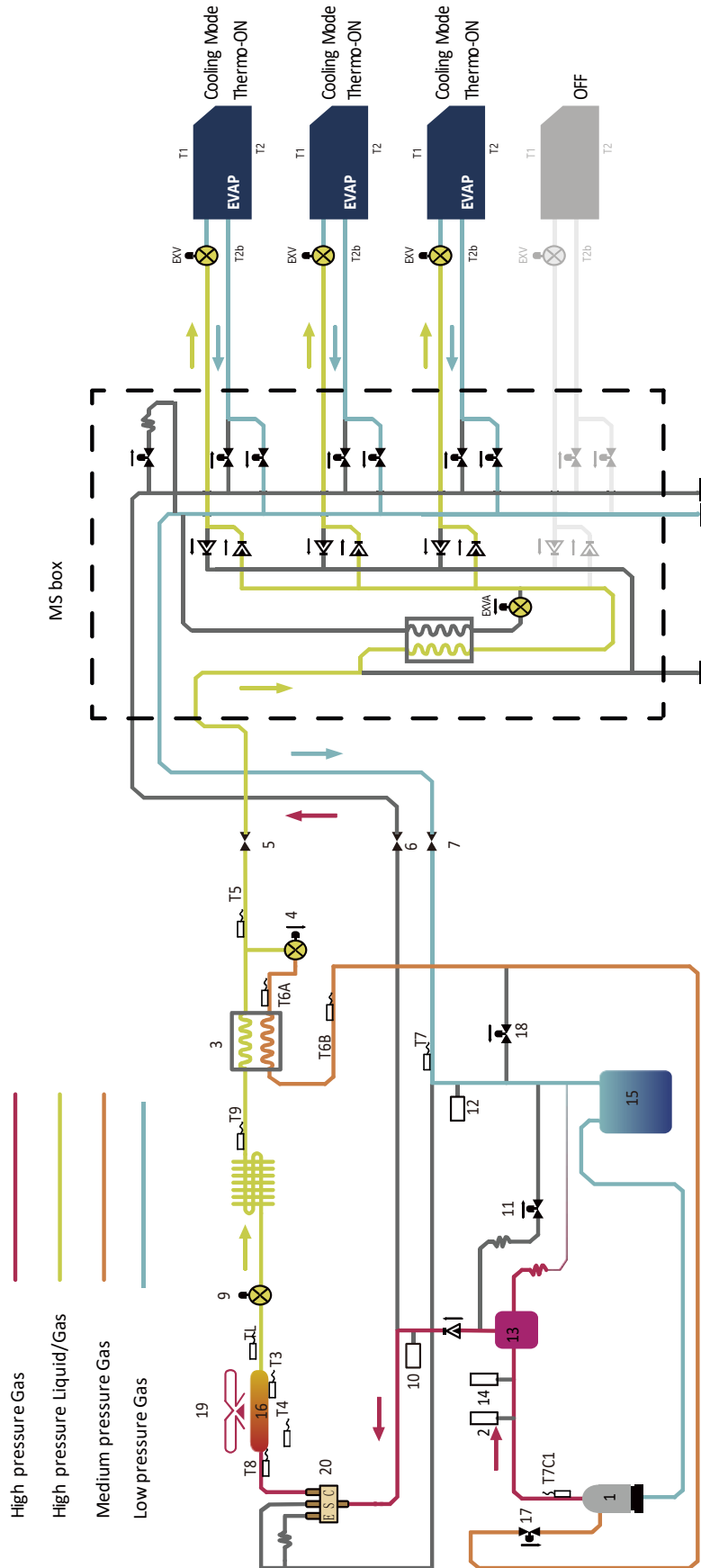

Heating operation

Figure 2-3.3: Refrigerant flow during heating operation

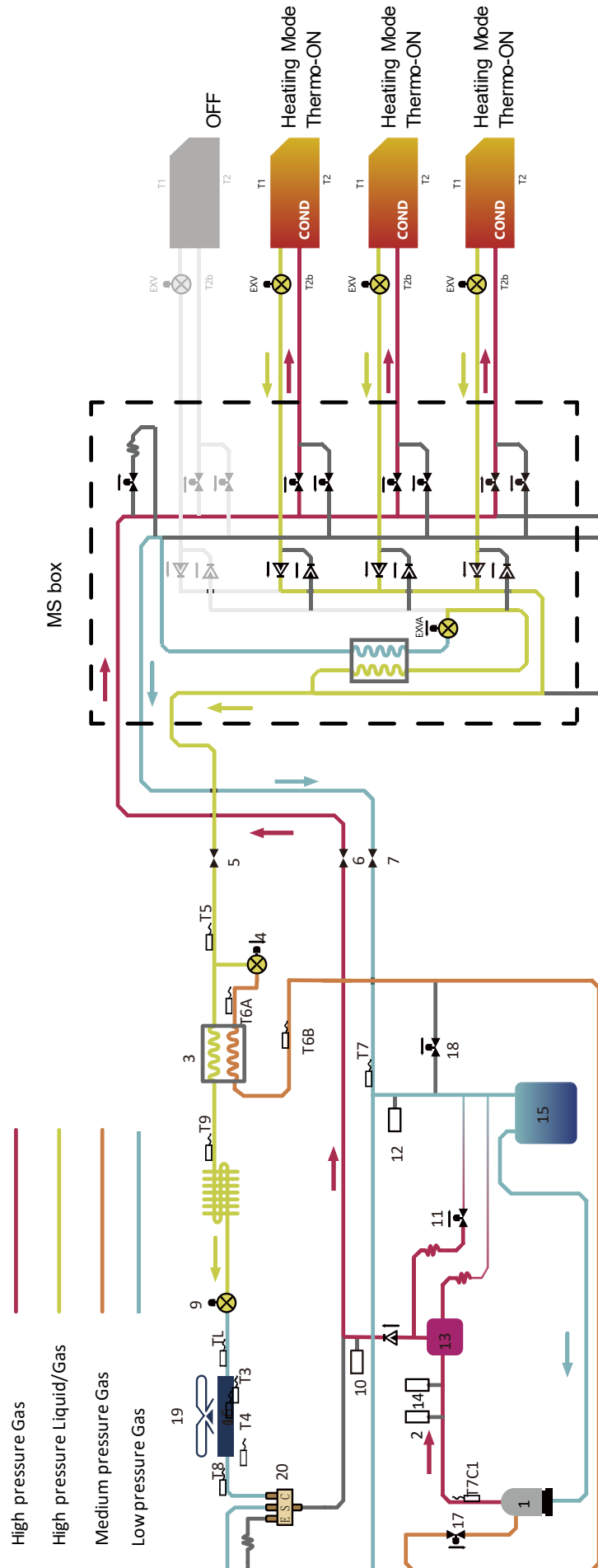

TVR Ultra HR 50/60Hz



Main heating operation

Figure 2-3.4: Refrigerant flow during main heating operation

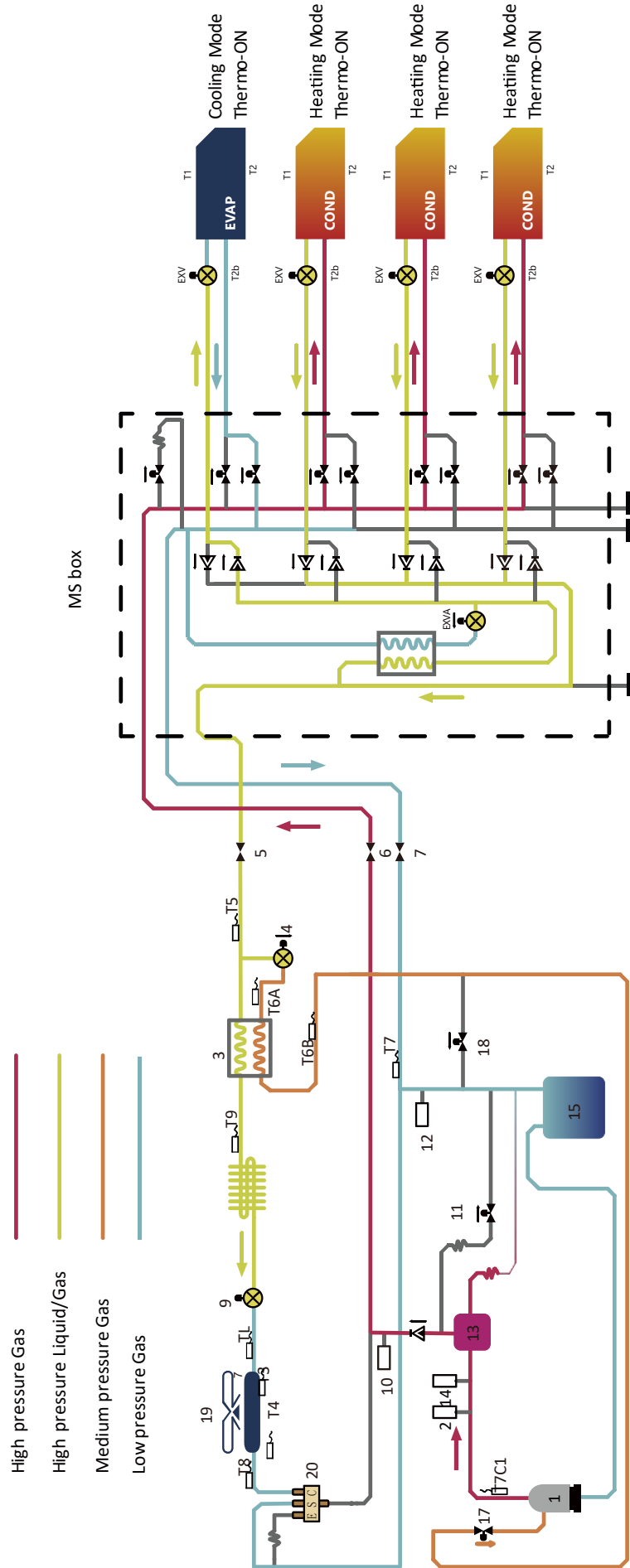

TVR Ultra HR 50/60Hz



Oil return operation in heating mode and defrosting operation

Figure 2-3.6: Refrigerant flow during oil return operation in heating mode and defrosting operation

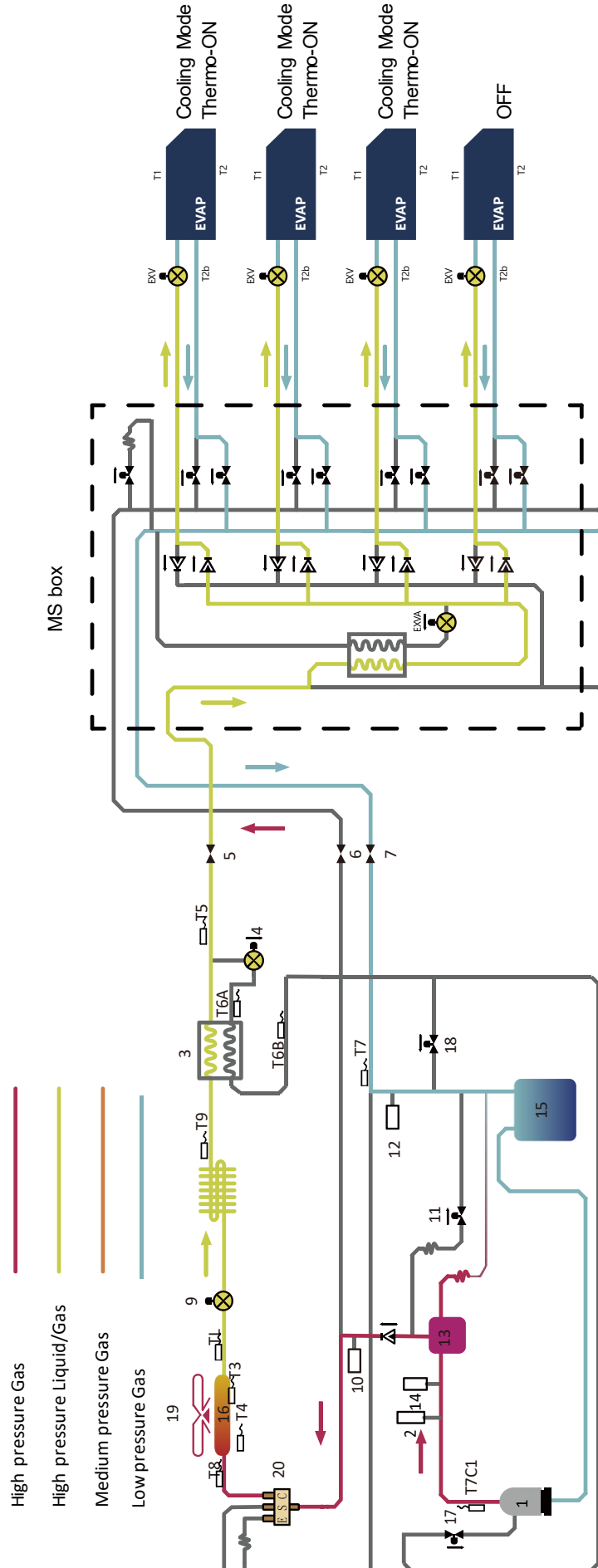

Part 3

Control

1	General Control Scheme Flowchart	26
2	Stop Operation.....	27
3	Standby Control	28
4	Startup Control	28
5	Normal Operation Control.....	31
6	Protection Control.....	37
7	Special Control.....	41
8	Other Control.....	46

1 General Control Scheme Flowchart

Sections 3-2 to 3-8 on the following pages detail when each of the controls in the flowchart below is activated.

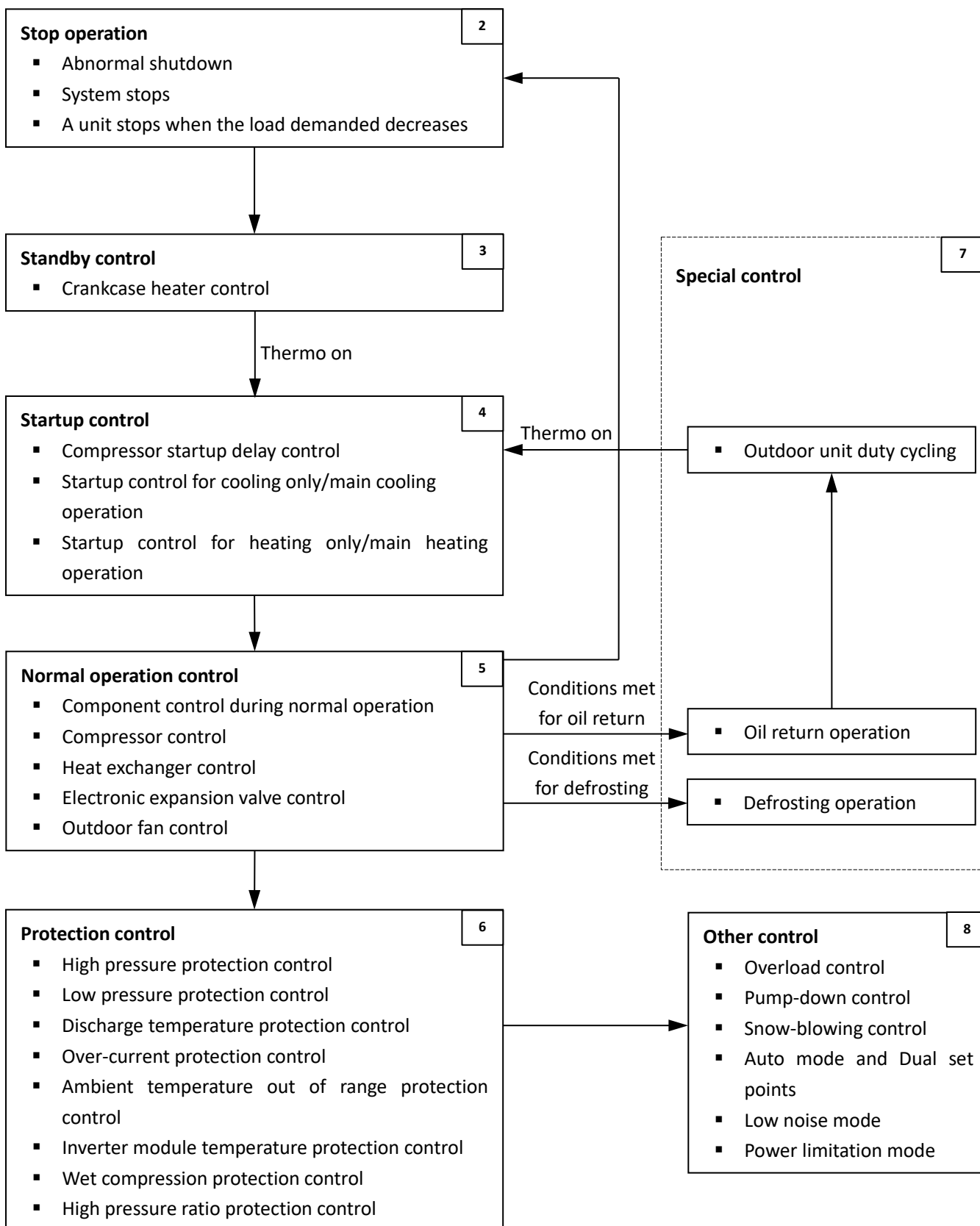

Legend
 Numbers in the top right-hand corners of boxes indicate the relevant section of text on the following pages.

2 Stop Operation

The stop operation occurs for one of the three following reasons:

1. Abnormal shutdown: in order to protect the compressors, if an abnormal state occurs the system makes a 'stop with thermos-off' operation and an error code is displayed on the outdoor unit digital displays.
2. The system stops when the set temperature of all indoor unit has been reached, or all indoor units has stop or error.
3. The ambient temperature is greater than 30°C and the number of cooling Thermo ON indoor unit is 0.

Table 3-2.1: Component control during stop operation

Part Name	Symbol	Stop control	
ODU	Inverter compressor A	INV1	OFF
	Inverter fan 1	FANA	Keeps for 2 min, then OFF
	Inverter fan 2	FANB ¹	
	Four way valve	ST1	Holds
	Electronic expansion valve	EEVA	0pls
		EEVC	0pls
	Solenoid valve	SV5	For single module: OFF For combination module: a. other module's compressor ON, keeps for 2 min, then OFF b. other module's compressor OFF, OFF for 30S → ON for 1min → OFF
SV8A		For single module: OFF For combination module: a. other module's compressor ON, keeps for 2 min, then OFF b. other module's compressor OFF, OFF	
SV7		OFF for 1min → ON for 3min → OFF	
MS04-MS12	Solenoid valve	SV(n)A	OFF
		SV(n)B	OFF
		SVP	OFF
Electronic expansion valve	EEVA	Keeps 0pls for 2 min, then 240pls	
MS01	Electric ball valve	EBVA	0pls, then 500pls
		EBVB	0pls, then 500pls
		EBVC	0pls, then 500pls
	Electronic expansion valve	EEVA	Keeps 0pls for 2 min, then 240pls

3 Standby Control

3.1 Crankcase Heater Control

The crankcase heater is used to prevent refrigerant from mixing with compressor oil when the compressors are stopped. The crankcase heater is controlled mainly according to discharge temperature.

When the discharge temperature is above 45°C, the crankcase heater is off; when the discharge temperature is below 40°C, the crankcase heater turns on if one of the three conditions is matched:

1. The first time powered on
2. In defrost operation
3. Ambient temperature < 10°C and the compressor stops for more than 4 hours

4 Startup Control

4.1 Startup Sequence and Frequency Control in Combination Modules

During the start-up process, the control of the compressor and the heat exchange mode is uniformly judged by the master outdoor unit, and the electronic expansion valve and solenoid valve are self-judged by the valve unit according to its own sensor status.

During the start-up process, the compressor frequency is based on the displacement frequency of the 70cc compressor. After the main outdoor unit is weighted and evenly distributed to each slave unit according to the maximum frequency, each slave unit performs the displacement frequency and convert it to actual frequency.

When combinational modules are started in parallel, the master outdoor unit is started first, and each slave outdoor unit is started with a delay of 5s.

4.2 Compressor Startup Delay Control

In initial startup control, compressor startup is delayed for 12 minutes in order to let the master unit search for the indoor units' addresses. In restart control (except in oil return operation and defrosting operation), compressor startup is delayed such that a minimum of 7 minutes has elapsed since the compressor stopped, in order to prevent frequent compressor on/off and to equalize the pressure within the refrigerant system.

4.3 Startup Control for Cooling Only/Main Cooling Operation
Table 3-4.1: Component control during startup in cooling only/main cooling mode

Component		Wiring diagram label	Before startup ¹	Startup control		
				STEP1	STEP2	STEP3
ODU	Inverter compressor A	INV1	0Hz	0Hz	Initial step for 30S, then +8Hz×Nstep / 10S. (Until it reaches Pc_max-Pe_min ≥ 0.2MPa)	8-10HP 42Hz, 12-22HP 51Hz, 24-34HP 88Hz, 36-60HP 138Hz, then adjust according to the high pressure and low pressure etc.
	Inverter fan 1	FANA	0 Step	0 step	Start: 0 step, then adjust by the high pressure and low pressure	PI control
	Inverter fan 2	FANB				
	Four way valve	ST1	Maintains previous position	Determined based on the initial mode of the heat exchanger		
	Electronic expansion valve	EEVA	0pls	Compressor operation, 2880pls Compressor not operation, initial 135pls, then adjusted according to the module temperature NTC.		
		EEVC	0pls	0pls	Compressor operation, 17pls→ +8pls per 20S based on high pressure or discharge temperature. Compressor not operation, 0pls.	
	Solenoid valve	SV5	OFF	ON		
SV8A		OFF	OFF	Compressor operation, ON Compressor not operation, OFF		
SV7		OFF→ON for 1min	ON	ON if Pc≥3.3MPa or Pe < 0.18MPa, else OFF.		
MS01	Electric ball valve	EVBA	OFF	Control based on IDUs' mode		
		EVBB	OFF			
		EVBC	OFF	2950pls		
Electronic expansion valve	EEVA	240 pulse	0pls			
MS04-12	Solenoid valve	SV(n)A	OFF	Control based on IDUs' mode		
		SV(n)B	OFF			
		SVP	OFF	OFF		
Electronic expansion valve	EEVA	240pls	0pls			
IDU	Fan	Fan	0 step	Setting speed by owners		
	Electronic expansion valve	EEV	300pls (500P EEV) 1200pls (2000P EEV)	500P EEV IDU: Maintain 300pls for 5min 2000P EEV IDU : Maintain 1200pls for 5min		
Ending conditions			60S	End if startup time arrives 5 min or the minimum superheat of discharge temperature ≥10°C or Tc_max > 50°C.		

Notes:

- The period for restarting after stopping is 7min when is necessary to equalize the pressure in the whole system.

4.4 Startup Control for Heating Only/Main Heating Operation

Table 3-4.2: Component control during startup in heating only / main heating mode

Component		Wiring diagram label	Before startup	Startup control		
				STEP1	STEP2	STEP3
ODU	Inverter compressor A	INV1	0Hz	0Hz	Initial step for 30s, then +8Hz×Nstep / 10s. (Until it reaches Pc_max-Pe_min ≥ 0.2MPa)	Adjust according to the high pressure and low pressure etc.
	Inverter fan 1	FANA	0 Step	0 step	Start: 0 step, then adjust by the high pressure and low pressure	PI control
	Inverter fan 2	FANB				
	Four way valve	ST1	Maintains previous position	Determined based on the initial mode of the heat exchanger		
	Electronic expansion valve	EEVA	pls	Condenser 2880pls, Evaporator 0pls	Condenser, 2880pls for 2min, then subcooling control Evaporator, adjusted according to the difference between ambient temperature and low-pressure saturation temperature.	
		EEVC	0pls	0pls	Compressor operation, 17pls→ +8pls per 20S based on high pressure or low pressure etc. Compressor not operation, 0pls.	
	Solenoid valve	SV5	OFF	ON		
SV8A		OFF	OFF	Compressor operation, ON Compressor not operation, OFF		
SV7		OFF→ON for 1min	ON	ON if Pc≥3.3MPa or Pe < 0.18MPa, else OFF.		
MS01	Electric ball valve	EVBA	OFF	Control based on IDUs' mode		
		EVBB	OFF			
		EVBC	OFF			
	Electronic expansion valve	EEVA	240 pulse	0pls		
MS04-12	Solenoid valve	SV(n)A	OFF	Control based on IDUs' mode		
		SV(n)B	OFF			
		SVP	OFF			
	Electronic expansion valve	EEVA	240 pulse	0pls		
IDU	Fan	Fan	0 step	Setting speed by owners(Anti-cold wind function is effective)		
	Electronic expansion valve	EEV	300pls (500P EEV) 1200pls (2000P EEV)	500P EEV IDU: Maintain 300pls for 3min 2000P EEV IDU : Maintain 1200pls for 3min		
Ending conditions			60S	End if startup time arrives 10 min or the minimum superheat of discharge temperature ≥ 10°C for 5min or Tc_max > 50°C.		

5 Normal Operation Control

5.1 Component Control During Normal Operation

Table 3-5.1: Outdoor unit component control during normal operation

Component	Wiring diagram label	Normal Cooling	Normal Heating	Normal Simultaneous Cooling / Heating
Inverter compressor A	COMP(A)	PI control, High pressure protection, Low pressure protection, Discharge temperature protection, Inverter Over-current protection control, Inverter module temperature protection control, Wet compression protection control, High pressure ratio protection control		
DC fan motor A	FANA	PI control	PI control	PI control
DC fan motor B ^{*1}	FANB			
Electronic expansion valve A	EEVA	Subcooling control, Inverter module temperature control	Subcooling control, Superheat control, Inverter module temperature control	Subcooling control, Superheat control, Inverter module temperature control
Electronic expansion valve C	EEVC	Superheat control	Superheat control	Superheat control
Four-way valve	ST1	Outdoor unit heat exchanger: Condenser / OFF Outdoor unit heat exchanger: Evaporator / ON		
Solenoid valve (fast defrosting (in heating) and unloading (in cooling))	SV5	ON with the following conditions: Ambient temperature $\geq 5^{\circ}\text{C}$ when heat exchanger act as evaporator or when ambient temperature $< 25^{\circ}\text{C}$ when state of heat exchanger act as condenser		
Solenoid valve (indoor units bypass)	SV7	ON when the low pressure is too low or the high pressure is too high		
Solenoid valve (inverter compressor A vapor injection)	SV8A	Compressor operation, ON Compressor not operation, OFF		

Table 3-5.2: Indoor unit component control during normal operation

Component	Normal cooling	Normal heating
Fan	Thermo ON unit	Remote controller setting
	Stopping unit	OFF
	Thermo OFF unit	Remote controller setting
Electronic expansion valve (EEV)	Thermo ON unit	Outlet temperature average control
	Stopping unit	500P EEV IDU: 56pls 3000P EEV IDU: 72pls
	Thermo OFF unit	500P EEV IDU: 56pls 3000P EEV IDU: 72pls

Table 3-5.3: MS04-12 component control during normal operation

Component	Wiring diagram label	Normal Cooling	Normal Heating	Normal Simultaneous Cooling / Heating
Electronic expansion valve A(Subcooling)	EEVA	Opls	Superheat PI control	Superheat PI control
Solenoid valve (Cooling)	SV(n)A	SV(n)A and SV(n)B turn ON or OFF depending on the operation mode of the port. Refer to table 3-5.4.		
Solenoid valve (Heating)	SV(n)B			
Solenoid valve (prevents fluid accumulation)	SVP	ON	OFF	

Table 3-5.4: SV(n)A and S SV(n)B turn ON or OFF depending on the operation mode of the port

ODU mode	IDU State	Solenoid Valve	
		SV(n)A	SV(n)B
Cooling only	Cooling	ON	OFF
	Cooling Thermo OFF		
	Fan		
	Error or Stop		
Normal Simultaneous Cooling / Heating	Error or Stop (OFF previously)	Maintain current state	Maintain current state
	Cooling	ON	OFF
	Cooling Thermo OFF		
	Fan		
	Error or Stop (Cooling previously)		
	Heating	OFF	ON
	Heating Thermo OFF		
	Error or stop (Heating previously)		
Mode conflict(Set the controller to display E0, default)			
Heating only	Heating	OFF	ON
	Heating Thermo OFF		
	Fan		
	Error or Stop	ON	OFF
	Mode conflict(Set the controller to display E0, default)		
	Mode conflict(Set the controller not to display E0)		

- Notes:
- Oil return and defrosting operation are basically identical with cooling only mode.
 - MS unit will neither respond to mode change when at oil return nor defrosting operation.
 - When multi indoor units connected to one port, it obeys the First priority. This means that if there is an indoor unit operates heating first, the other one in this port can't operate cooling or Fan.
 - SV(n)A and SV(n)B close immediately after the compressor shut down.
 - There is a delay action to avoid SV(n)A and SV(n)B change at the same time (OFF+ON→ON+OFF e.g).

Table 3-5.5: MS01 component control during normal operation

Component	Wiring diagram label	Normal Cooling	Normal Heating	Normal Simultaneous Cooling / Heating
Electronic expansion valve A(Subcooling)	EEVA	Opls	Superheat PI control	Superheat PI control
Electric ball valve (Low pressure gas valve)	EVBA	ON or OFF depending on the operation mode of the port. Refer to table 3-5.6.		
Electric ball valve (High pressure gas valve)	EVBB			
Electric ball valve (Liquid valve)	EVBC			
Solenoid valve (prevents fluid accumulation)	SVP	ON	OFF	

Table 3-5.6: Electric ball valve turn ON or OFF depending on the operation mode of the port.

ODU mode	IDU state	Electric ball valve					
		EVBA		EVBB		EVBC	
Cooling only	Cooling	2950pls	current	0pls	2950pls	current	
	Cooling Thermo OFF						
	Fan						
	Error or Stop						
Normal Simultaneous Cooling / Heating	Error or Stop (OFF previously)	Maintain state	current	Maintain state	current	Maintain state	current
	Cooling	2950pls	current	0pls	2950pls	current	
	Cooling Thermo OFF						
	Fan						
	Error or Stop (Cooling previously)	2950pls	current	0pls	2950pls	current	
	Heating						
	Heating Thermo OFF						
Error or stop (Heating previously)							
Heating only	Heating	0pls	current	2950pls	2950pls	current	
	Heating Thermo OFF						
	Fan						
	Error or Stop	2950	current	0pls	2950pls	current	
	mode conflict(Set the controller to display E0, default)						
	mode conflict(Set the controller not to display E0)						

5.2 Compressor Control

Cooling operation

Compressor frequency is PI controlled to keep low pressure at target temperature.

Te: Low pressure equivalent saturation temperature (°C)

Tes: Target Te value.

Tes will be decided by Te setting, if you choose Auto that means except Te setting, the Tes would be adjusted according to the ambient temperature, refrigerant pipe length, etc.

Table 3-5.7: Te setting

Setting	1 (Default)	2	3	4	5	6	7	8
Tes(C)	6 Auto	0 Auto	3 Auto	9 Fixed	6 Fixed	3 Fixed	0 Fixed	-3 Fixed

Heating operation

Compressor frequency is PI controlled to keep high pressure at target temperature.

Tc: High pressure equivalent saturation temperature (°C)

Tcs: Target Tc value.

Tcs will be decided by Tc setting, if you choose Auto that means except Tc setting, the Tcs would be adjusted according to the ambient temperature, refrigerant pipe length, etc.

Table 3-5.8: Tc setting

Setting	1 (Default)	2	3	4	5	6	7	8
Tcs(C)	48 Auto	50 Auto	45 Auto	42 Fixed	44 Fixed	46 Fixed	48 Fixed	51 Fixed

Simultaneous cooling and heating operation

It controls compressor capacity to adjust Tc to target value (Tcs) and Te to target value (Tes).

5.3 Rotation of Compressors

In order to make operating time equal for each compressor of combination outdoor units, outdoor units are used in rotation. Figures 3-5.1 to 3-5.2 show the compressor rotation in systems with two and three units. The master unit and slave units 1 and 2 are shown from left to right in that order, and the circled numbers (①, ②, ③) indicate the rotation sequence.

Figure 3-5.1: Compressor priority and rotation – two outdoor units

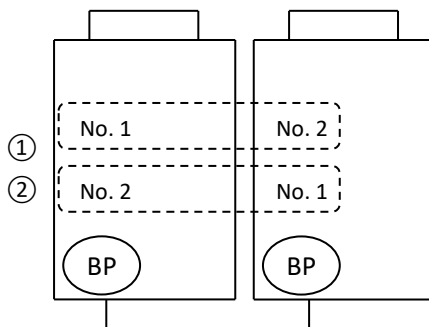
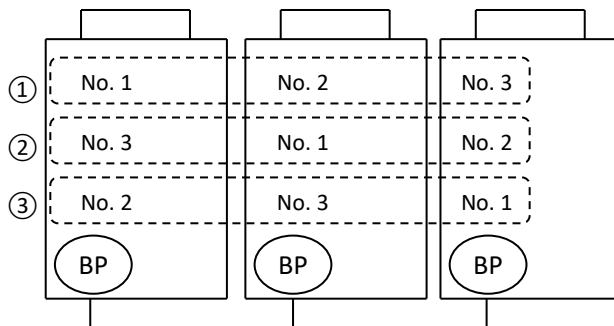

Figure 3-5.2: Compressor priority and rotation – three outdoor units



5.4 Heat Exchanger Control

The mode of the outdoor units is uniformly controlled by the master outdoor unit: the master outdoor unit check status of the outdoor unit heat exchanger and sends the calculation result to each slave unit, and each slave unit control their own four-way valve, fan and EEVA.

In cooling only operation, heating only operation and simultaneous cooling and heating operation, the states (evaporator or condenser) of air heat exchange changes to ensure target condensing and evaporating temperature.

5.5 Electronic Expansion Valve Control

EEVA control

The positions of electronic expansion valves EEVA are controlled in steps from 0 (fully closed) to 2880 (fully open).

When the outdoor unit heat exchanging is performed via the evaporator, this function is used to exert PI control on the electronic expansion valve EEVA so that the evaporator outlet superheated degree (SH) will become constant.

$$SH = T_g - T_e$$

SH: Evaporator outlet superheated degree (°C)

T_g: Suction pipe temperature (°C) detected by the heat exchanger gas pipe thermistor T8.

T_e: Low pressure equivalent saturated

When the outdoor unit heat exchanging is performed via the condenser, this function is used to exert PI control on the electronic expansion valve EEVA so that the condenser outlet subcooled degree (SC) will become constant.

$$SC = T_c - T_L$$

SC: Condenser outlet subcooled degree (°C)

T_L: Liquid pipe temperature (°C) detected by the heat exchanger gas pipe thermistor TL.

T_c: High pressure equivalent saturated

EEVC control

The positions of electronic expansion valves EEVC are controlled in steps from 0 (fully closed) to 480 (fully open).

In order to make the maximum use of the subcool heat exchanger, this function is used to exert PI control on the electronic expansion valve EEVC so that the evaporator-side gas pipe superheated degree (SH) or discharge temperature(T7C1) will become constant.

$$SH = T_{6B} - T_{6A}$$

SH: Evaporator outlet superheated degree (°C)

T_{6A}: Suction pipe temperature (°C) detected by the plate heat exchanger inlet thermistor T6A.

T_{6B}: Suction pipe temperature (°C) detected by the plate heat exchanger outlet thermistor T6B.

5.6 Outdoor Fan Control

The speed of the outdoor unit fans is adjusted in steps, as shown in Table 3-5.9

Table 3-5.9: Outdoor fan speed steps

Fan speed index	Fan speed (rpm)		Note
	8-12HP	14-20HP FANA / FANB	
0	0	0/0	Stop operation Startup or defrosting control
1	120	150/0	
2	130	180/0	
3	140	210/0	
4	150	240/0	
5	170	270/0(150/150)	
6	190	300/0(180/180)	
7	210	330/0(210/210)	
8	230	360/0(240/240)	
9	250	270/270	
10	280	300/300	
11	310	330/330	
12	340	360/360	
13	370	390/390	
14	400	420/420	
15	430	460/460	
16	460	500/500	
17	500	540/540	
18	530	580/580	
19	560	620/620	
20	600	660/660	
21	630	710/710	
22	660	760/760	
23	700	810/810	
24	740	860/860	8/14HP Standard step
25	780	910/910	10/16HP Standard step
26	820	960/960	12/18/20HP Standard step
27	860	1000/1000	
28	900	1040/1040	
29	940	1080/1080	
30	980	1120/1120	

Notes:

1. Standard step means the max. step in standard static pressure mode (0Pa default).

Table 3-5.10 Upper limit fan step in static pressure mode

Static Pressure mode	Upper limit fan step (8-12HP)	Upper limit fan step (14-20HP)
Supper high static pressure mode(80Pa)	+4 step	+4 step
High static pressure mode(60Pa)	+3 step	+3 step
Medium static pressure mode(40Pa)	+2 step	+2 step
Low static pressure mode(20Pa)	+1 step	+1 step
Standard static pressure mode (0Pa. default)	+0 step	+0 step

6 Protection Control

6.1 High Pressure Protection Control

This control protects the system from abnormally high pressure and protects the compressors from transient spikes in pressure.

Figure 3-6.1: High pressure protection control in cooling operation

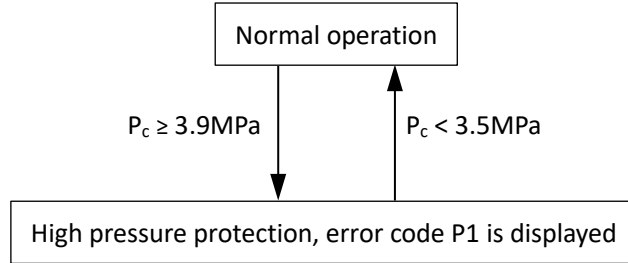

Notes:

1. P_c : Discharge pressure

Figure 3-6.2: High pressure protection control in heating operation

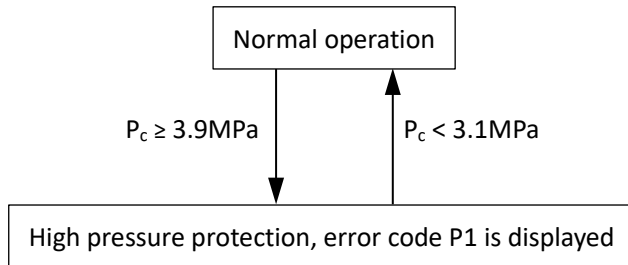

Notes:

1. P_c : Discharge pressure

6.2 Low Pressure Protection Control

This control protects the system from abnormally low pressure and protects the compressors from transient drops in pressure.

Figure 3-6.3: Low pressure protection control in cooling operation

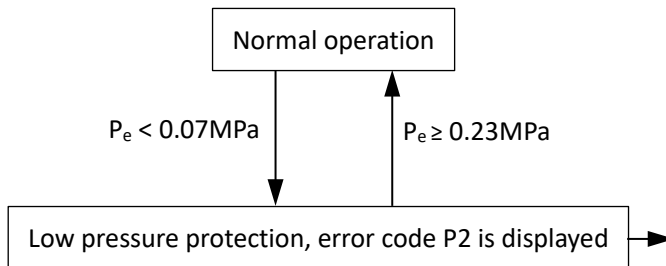

Notes:

1. P_e : Suction pressure

When P2 protection occurs 3 times in 60 minutes, the H5 error is displayed. When an H5 error occurs, a manual system restart is required before the system can resume operation.

Figure 3-6.4: Low pressure protection control in heating operation

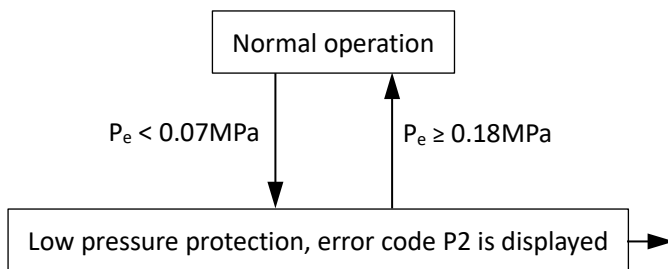

When P2 protection occurs 3 times in 60 minutes, the H5 error is displayed. When an H5 error occurs, a manual system restart is required before the system can resume operation.

- Notes:
1. P_e : Suction pressure

6.3 Discharge Temperature Protection Control

This control protects the compressors from abnormally high temperatures and transient spikes in temperature. It is performed for each compressor.

Figure 3-6.5: Discharge temperature protection control

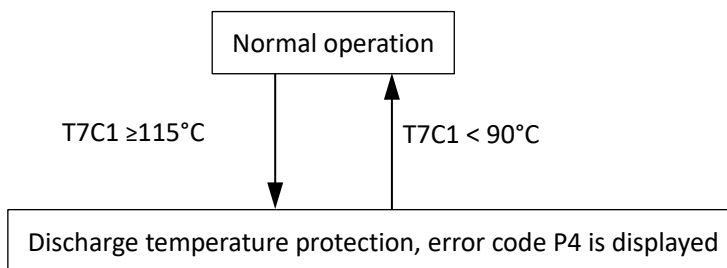

- Notes:
1. T7C1: Compressor discharge temperature

When the discharge temperature rises above 115°C the system displays P4 protection and all units stop running. When P4 protection occurs 3 times in 100 minutes, the H6 error is displayed. When an H6 error occurs, a manual system restart is required before the system can resume operation.

6.4 Over-current Protection Control

Over current protection control is performed to prevent tripping due to transient inverter over-current. It protects the compressors from abnormally high currents. It is performed for each compressor.

Figure 3-6.6: Over-current protection control

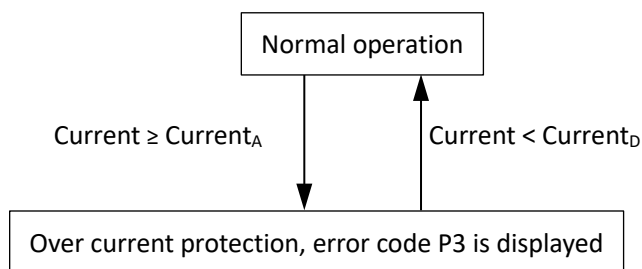

Table 3-6.1: Current limitation for compressor inverter modules

Model	8HP	10HP	12HP	14HP	16HP	18HP	20HP
Current _A	104	116	128	142	150	158	158
Current _D	76	88	100	122	130	138	138

- Notes:
1. The current limitation value is the actual current * 4

6.5 Ambient temperature out of range protection control

When the outdoor ambient temperature rises above 30.5°C heating mode is disabled to prevent the mechanical load on compressors becoming too high and to prevent low compression ratios which can result in insufficient compressor internal oil lubrication.

Figure 3-6.7: Disable heating control

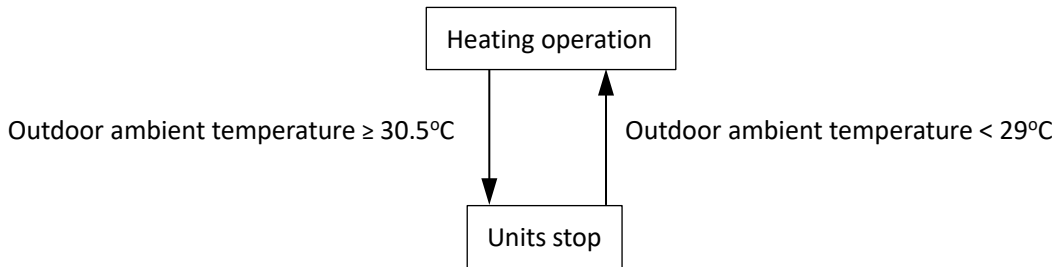

When the outdoor ambient temperature rises above 55°C or outdoor ambient temperature drops below -16°C, cooling mode is disabled to protect the compressor.

Figure 3-6.8: Disable cooling control

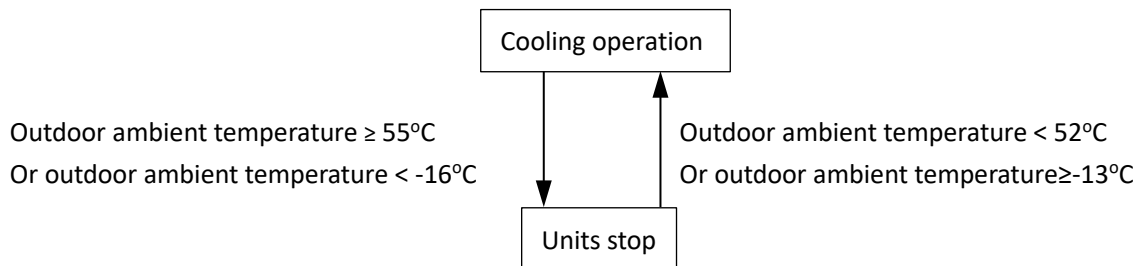

Notes:

1. If the indoor unit operates in cooling mode below -5 °C, the temperature of the indoor unit's air outlet may be lower than 0 degrees.

6.6 Inverter Module Temperature Protection Control

This control protects the compressors from abnormally high currents and protects the inverter modules from abnormally high temperatures. It is performed for each compressor and inverter module.

Figure 3-6.9: Inverter module temperature protection control

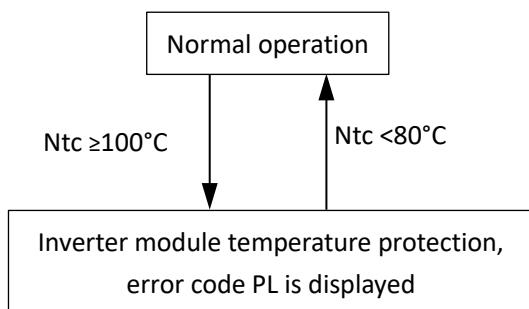

Notes:

1. Ntc: Inverter module temperature

When PL protection occurs 3 times in 100 minutes, the C7 error is displayed. When a C7 error occurs, a manual system restart is required before the system can resume operation.

6.7 Wet Compression Protection Control

This protection is used to prevent compressor from damaging for the long time wet compression so that it can't be lubricated well. This control is performed for each compressor.

Figure 3-6.10: Wet compression protection control

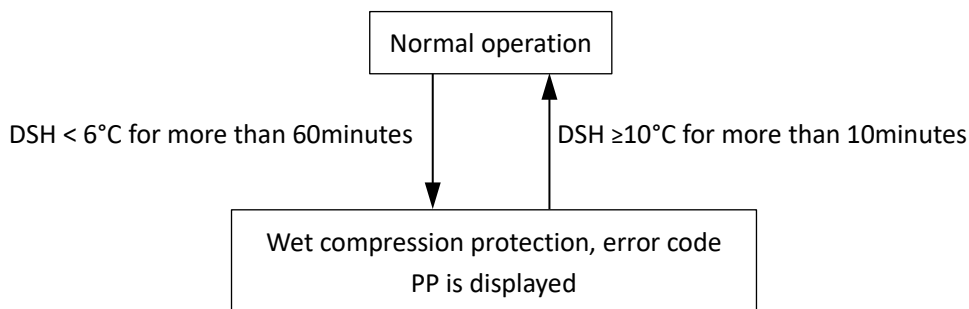

Notes:

1. DSH: Superheat of discharge temperature

6.8 High Pressure Ratio Protection Control

This high pressure ratio protection control is used to prevent the activation of protection devices due to abnormal increase of high pressure ratio, and to protect compressors against the transient increase of high pressure ratio. It is performed for entire system.

Figure 3-6.11: High pressure ratio protection control

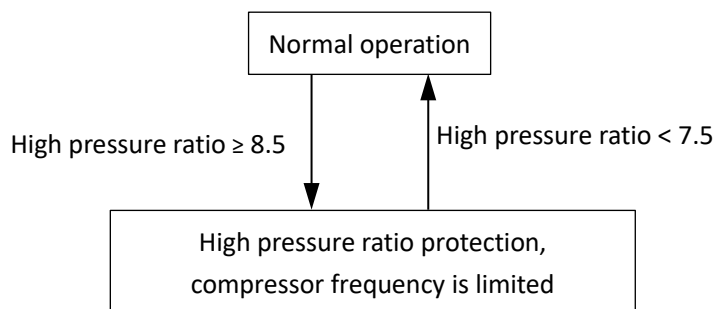

Notes:

1. P_c : Discharge pressure P_e : Suction pressure
2. Pressure Ratio = $(P_c + 0.10) / (P_e + 0.10)$

7 Special Control

7.1 Oil Return Operation

In order to prevent compressors from running out of oil, the oil return operation is conducted to recover oil that has flowed out of the compressor(s) and into the piping system. This operation is performed for all units including units that are in standby.

When the outdoor unit is running in oil return, the digital display on outdoor main PCB will display “d0”.

Cooling Only/Main Cooling Oil Return Control

Timing of oil return operation:

- Calculated oil discharge has reached to specified level. The higher the compressor frequency step is, the more oil discharge.
- Initial cumulative compressor operating time reaches 2 hours.
- Cumulative compressor operating time reaches 8 hours.

Tables 3-7.1 and Tables 3-7.2 show component control during oil return operation in cooling only/main cooling mode.

Table 3-7.1: Outdoor unit and MS component control during oil return operation in cooling only/main cooling mode

Component	Wiring diagram label	Cooling oil return control			
		STEP1	STEP2	STEP3	
ODU	Inverter compressor	INV1	PI control, the minimum step is as follows: 8-10HP 28Hz 12-22HP 61Hz 24-34HP 105HZ 36-60HP 165Hz	8-10HP 28Hz 12-22HP 61Hz 24-34HP 105HZ 36-60HP 165Hz	Minimum step(All outdoor unit compressors are running).
	Inverter fan 1	FANA	PI control(Cooling Only)		
	Inverter fan 2	FANB			
	Four way valve	ST1	ON	Back to the state before oil return	
	Electronic expansion valve	EEVA	Compressor operation, 2880pls Compressor not operation, initial 135pls, then adjusted according to the module temperature		
		EEVC	0pls	Compressor operation, 17pls→ +8pls per 20S based on high pressure or discharge temperature. Compressor not operation, 0pls.	
	Solenoid valve	SV5	ON	Refer to normal operation control	
SV8A		ON			
SV7		OFF	Turn ON/OFF based on the low pressure and the high pressure etc.		
MS01	Electric ball valve	EVBA	2950pls		
		EVBB	0pls		
		EVBC	2950pls		
Electronic expansion valve	EEVA	0pls			
MS04-12	Solenoid valve	SV(n)A	ON		
		SV(n)B	OFF		
		SVP	OFF		
	Electronic expansion valve	EEVA	0pls		
Ending conditions		End if startup time arrives 150S.	End if startup time arrives 6 min or the compressor discharge volume ≥ Target value for 4min.	After 30S.	

Table 3-7.2: Indoor unit component control during oil return operation in cooling only/main cooling mode

Cooling indoor unit		2000P EEV	500P EEV
FAN	Thermo ON unit	Keep the previous fan speed	
	Thermo OFF unit		
	Stop or Fan		
Electronic expansion valve (EEV)	Thermo ON unit	Superheat control	
	Thermo OFF unit	1200pls	300pls
	Stop or Fan	1200pls	300pls
Heating indoor unit (ODU operates cooling main operation)		2000P EEV	2000P EEV
FAN (Set the controller to display E0, default)	Thermo ON unit	OFF	
	Thermo OFF unit	OFF	
	Stop	OFF	
FAN (Set the controller not to display E0)	Thermo ON unit	Low fan speed	
	Thermo OFF unit	Low fan speed	
	Stop	OFF	
Electronic expansion valve (EEV) (Set the controller to display E0, default)	Thermo ON unit	Within 2min: 1920pls	Within 2min: 480pls
	Thermo OFF unit	2-4min: 1200pls	2-4min: 300pls
	Stop or error stop	After 4min: 480pls	After 4min: 120pls
Electronic expansion valve (EEV) (Set the controller not to display E0)	Thermo ON unit	0pls	0pls
	Thermo OFF unit		
	Stop or error stop		

Heating Oil Return Control

It's basically identical with defrosting operation, refer to 7.2 Defrosting Operation

7.2 Defrosting Operation

In order to recover heating capacity, the defrosting operation is conducted when the outdoor unit heat exchanger is performing as an evaporator. The defrosting operation is controlled according to outdoor ambient temperature, outdoor heat exchanger temperature, indoor heat exchanger temperature and outdoor units running time. When the outdoor unit is running in defrosting, the digital display on outdoor main PCB will display “df”.

Reverse Cycle Defrosting Operation

Timing of reverse cycle defrosting operation:

- $T_e < -2^{\circ}\text{C}$ and $T_4 < 20^{\circ}\text{C}$, meeting either of the points below:
 - 1) When there is an obviously drop in the temperature of outdoor unit heat exchanger outlet
 - 2) When cumulative operating time after the latest defrosting control arrives an hour
- Compulsive defrosting or oil return set manually after PI control 1min. (Set n17 by “SW5” in main board or spot check board)

Table 3-7.3: Outdoor unit and MS component control during defrosting operation

Component		Wiring diagram label	Defrosting operation control				
			Control before Defrosting	Defrosting control	Control after Defrosting		
ODU	Inverter compressor A	INV1	Reduce frequency step	One ODU unit system: 28Hz, upper limit 88Hz Two ODU units system: 56Hz, upper limit 176Hz Three ODU units system: 84Hz, upper limit 264Hz	Current frequency enters PI control	PI control	
	Inverter fan 1	FANA	PI control	Initial OFF But 10 Step or higher if the high pressure is larger than 2.2MPa.	Initial step then PI control		
	Inverter fan 2	FANB					
	Four way valve	ST1	ON			Initial step according to ambient temperature and indoor load	
	Electronic expansion valve	EEVA	Compressor operation, 2880pls Compressor not operation, initial 135pls, then adjusted according to the module temperature				
		EEVC	0pls	Compressor operation, 17pls→ +8pls per 20S based on high pressure or discharge temperature. Compressor not operation, 0pls.			
	Solenoid valve	SV5	ON				
SV8A		Compressor operation, ON Compressor not operation, OFF					
SV7		Turn ON/OFF based on the low pressure and the high pressure etc.					
MS01	Electric ball valve	EVBA	Normal Operation Control	2950pls	Normal Operation Control		
		EVBB	Normal Operation Control	0pls	Normal Operation Control		
		EVBC	Normal Operation Control	2950pls	Normal Operation Control		
	Electronic expansion valve	EEVA	Normal Operation Control	0pls	Normal Operation Control		
MS04-12	Solenoid valve	SV(n)A	Normal Operation Control	ON	Normal Operation Control		
		SV(n)B	Normal Operation Control	OFF	Normal Operation Control		
		SVP	Normal Operation Control	OFF	Normal Operation Control		
		Electronic expansion valve	EEVA	Normal Operation Control	0pls	Normal Operation Control	
Ending conditions			End if $P_c - P_e < 0.4\text{MPa}$, Maximum 120S	Defrost completion condition judgment, maximum time is 9min	90S or $P_c - P_e < 0.4\text{MPa}$ for 20S	After 30S	

Defrosting control time is no less than 135S and fulfill one of the conditions below:

- $P_c - \text{max} \geq 3.0\text{MPa}$.
- Total defrosting control time has reached 9 minutes.
- $T_3_min > \text{Target value}$ for a certain time.

Table 3-7.4: Indoor unit component control during defrosting operation

Cooling indoor unit		2000P EEV	500P EEV
FAN	Thermo ON unit	Keep the previous fan speed	
	Thermo OFF unit		
	Stop or Fan		
Electronic expansion valve (EEV)	Thermo ON unit	Superheat control	
	Thermo OFF unit	1200pls	300pls
	Stop or Fan	1200pls	300pls
Heating indoor unit (ODU operates cooling main operation)		2000P EEV	2000P EEV
FAN (Set the controller to display E0, default)	Thermo ON unit	OFF	
	Thermo OFF unit	OFF	
	Stop	OFF	
FAN (Set the controller not to display E0)	Thermo ON unit	Low fan speed	
	Thermo OFF unit	Low fan speed	
	Stop	OFF	
Electronic expansion valve (EEV) (Set the controller to display E0, default)	Thermo ON unit	Within 2min: 1920pls	Within 2min: 480pls
	Thermo OFF unit	2-4min: 1200pls	2-4min: 300pls
	Stop or error stop	After 4min: 480pls	After 4min: 120pls
Electronic expansion valve (EEV) (Set the controller not to display E0)	Thermo ON unit	0pls	
	Thermo OFF unit		
	Stop or error stop		

Rotating Defrosting Operation

Timing of rotating defrosting operation:

Te < -2°C and T4 < 20°C, and either of the points below is met:

- There is an obviously drop in the temperature of outdoor unit heat exchanger outlet
- Cumulative operating time after the latest defrosting control arrives an hour

Switching action of two-module parallel system heat exchanger

Figure 3-7.2: Switching action of two-module parallel system heat exchanger

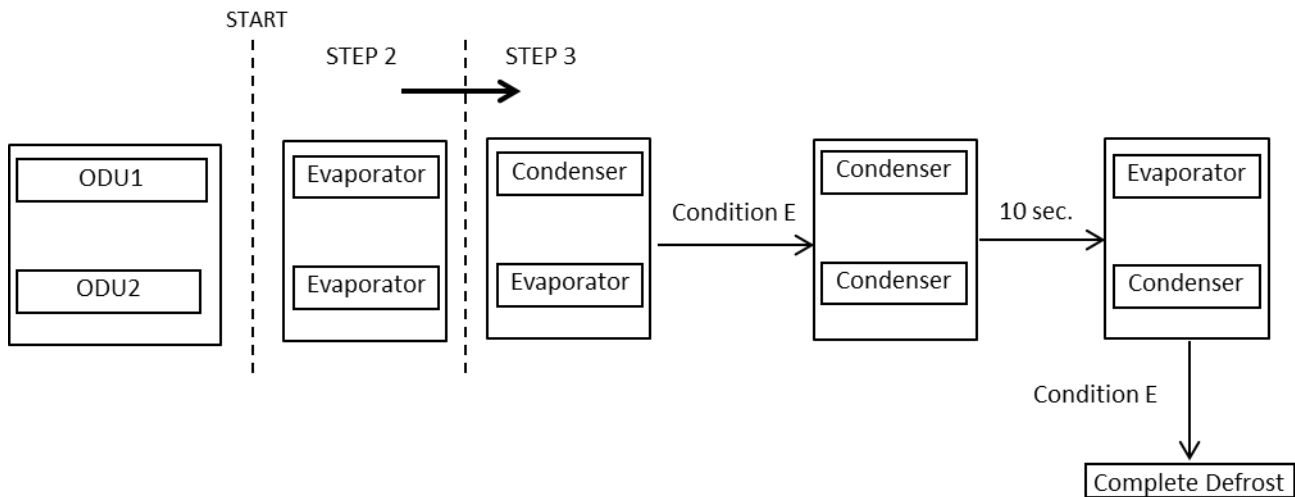

Condition E

- Total defrosting control time has reached 5 minutes.
- T3 > Target value for a certain time.

Notes:

- This function is only available when the indoor units connected in TVR ULTRA HR system are 2nd generation AC VRF indoor units (which will be released soon) or 2nd generation DC VRF indoor units produced after May 31st, 2020 only (The package of upgraded indoor units will add yellow label on both sides to distinguish the indoor units before and after the upgrade).

Switching action of three-module parallel system heat exchanger

Figure 3-7.3: Switching action of three-module parallel system heat exchanger

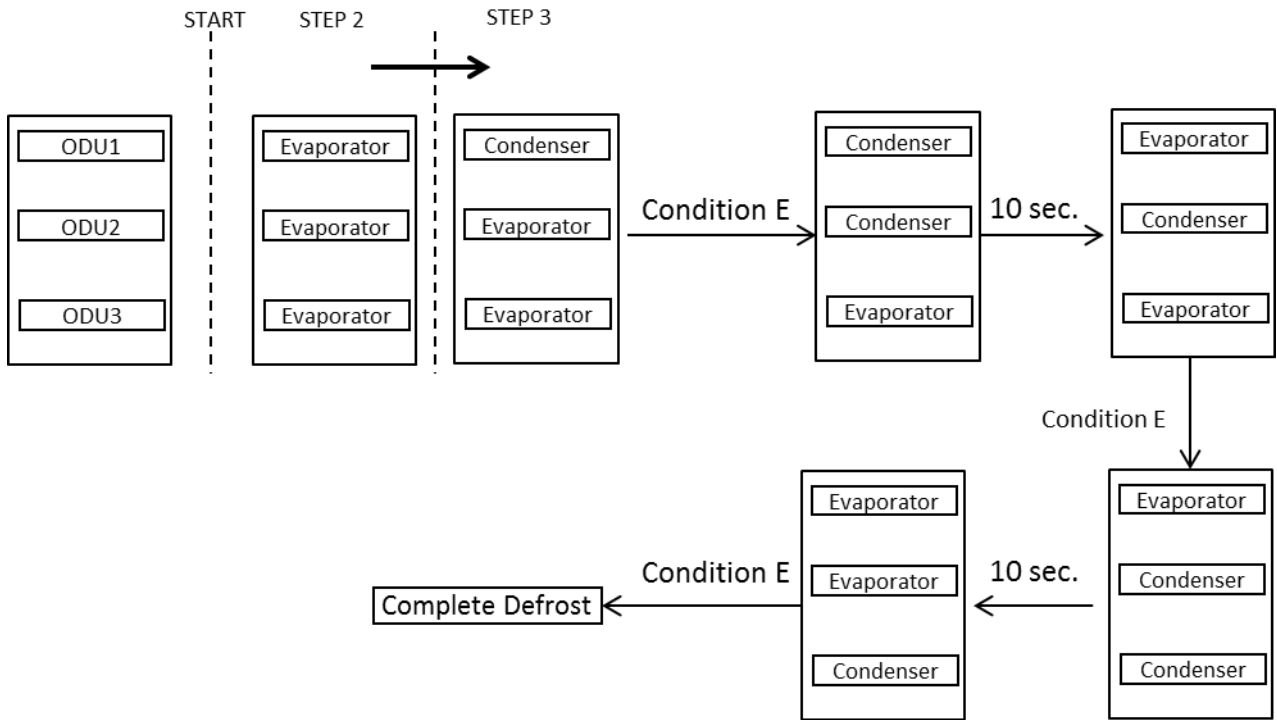

Condition E

- Total defrosting control time has reached 5 minutes.
- T3 > Target value for a certain time.

Notes:

1. This function is only available when the indoor units connected in TVR ULTRA HR system are 2nd generation AC VRF indoor units (which will be released soon) or 2nd generation DC VRF indoor units produced after May 31st, 2020 only (The package of upgraded indoor units will add yellow label on both sides to distinguish the indoor units before and after the upgrade).

8 Other Control

8.1 Overload control

Overload control is used to maintain comfort requirement (i.e. outlet air temperature) and keep proper system pressure.

Figure 3-8.1: Overload control

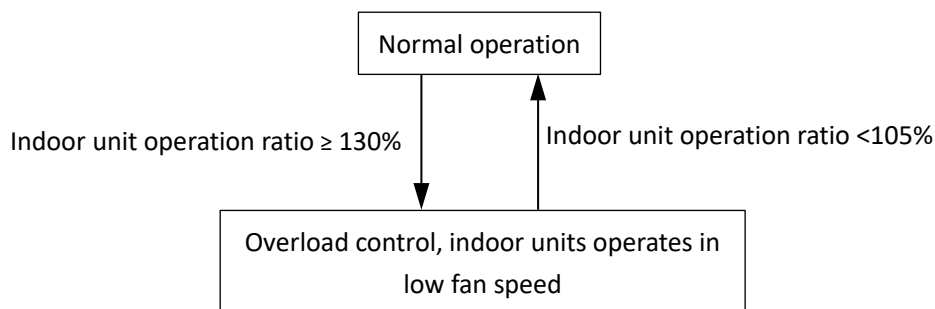

Notes:

1. Indoor unit operation ratio = Indoor unit operates capacity index (in the same mode)/ outdoor unit capacity index

8.2 Pump-down Control

Recover refrigerant to outdoor unit

Recover refrigerant to outdoor unit is used to recover the refrigerant from indoor units and MS box before service work. The LED display r001 in this control.

Table 3-8.1: Recover refrigerant to outdoor unit

Component		Wiring diagram label	Startup control	Normal control	Pump down		
ODU	Inverter compressor A	INV1	Refer to startup control in cooling operation	Tes = -15°C Upper limit: 60 Hz	30Hz		
	Inverter fan 1	FANA		PI control	PI control		
	Inverter fan 2	FANB					
	Four way valve	ST1		OFF	OFF	OFF	
	Electronic expansion valve	EEVA			2880pls	2880pls	
		EEVC			0pls	0pls	
	Solenoid valve	SV5			ON	ON	
SV8A			ON	ON			
SV7			OFF	OFF			
MS01	Electric ball valve	EVBA	Cooling only normal control				
		EVBB					
		EVBC					
Electronic expansion valve	EEVA						
MS04-12	Solenoid valve	SV(n)A					
		SV(n)B					
		SVP					
Electronic expansion valve	EEVA						
IDU	Fan	Fan					
	Electronic expansion valve	EEV					
Ending conditions						30min or Pe < 0.2MPa	Meet any points below: <ul style="list-style-type: none"> • Pump down time elapses 5min. • Pe < 0.12MPa • T7C1_Max ≥ 105°C • Pc ≥ 3.6MPa

Notes:

1. Pc: Discharge pressure Pe: Suction pressure
2. Tes : Target evaporating temperature T7C1: Compressor discharge temperature

Recover refrigerant to indoor units and MS boxes

In order to recover the refrigerant from the outdoor unit to indoor units, MS boxes and connection pipes, this pump-down operation is conducted as below and the LED display r002 in this control.

Table 3-8.2: Recover refrigerant to indoor units and MS units

Component		Wiring diagram label	Startup control	Normal control	Pump down	
ODU	Inverter compressor A	INV1	ON	Tcs = 43°C Upper limit: 60 Hz	30Hz	
	Inverter fan 1	FANA		PI control	PI control	
	Inverter fan 2	FANB				
	Four way valve	ST1		ON	ON	ON
	Electronic expansion valve	EEVA		Refer to startup control in Heating operation	Heating only normal control	Heating only normal control
		EEVC			Opls	Opls
	Solenoid valve	SV5			ON	ON
SV8A		ON	ON			
SV7		OFF	OFF			
MS01	Electric ball valve	EVBA	Heating only normal control			
		EVBB				
		EVBC				
MS04-12	Solenoid valve	SV(n)A				
SV(n)B						
SVP						
IDU	Electronic expansion valve	EEVA				
		EEV				
Ending conditions				30min or $P_e < 0.2\text{MPa}$		Meet any points below: <ul style="list-style-type: none"> Pump down time elapses 5min. $P_e < 0.12\text{MPa}$ $T7C_{\text{Max}} \geq 105^\circ\text{C}$ $P_c \geq 3.6\text{MPa}$

Notes:

1. P_c : Discharge pressure P_e : Suction pressure
2. Tcs : Target condensing temperature $T7C1$: Compressor discharge temperature

Vacuum control

This control is used to open solenoid valves and electronic expansion valves in the whole system. The LED display r003 to activate this control.

- During the vacuum work, the high/low pressure sensor error and low pressure protection should be ineffective (Use short connectors if not).
- The 4-way valve is OFF, and compressors or fans are prohibited to run.

8.3 Auto Snow-blowing Control

Auto snow-blowing control is used to prevent the fans of stopped outdoor units from destroying by heavy snow.

Timing of auto snow-blowing operation:

$T4 \leq 3^{\circ}\text{C}$ and outdoor units stops time elapse for TA.

Table 3-8.3: Snow-blowing control

Model	Fan Step	TA: Level a (Menu mode nb5)	TA: Level b (Menu mode nb6)	Disabled (Menu mode nb7, default)
8-12HP	15	30min	15min	/
14-20HP				

When $T4 > 3^{\circ}\text{C}$ or the outdoor unit starts operation, the time accumulated for auto snow-blowing is reset to 0.

8.4 Auto Mode and Dual Set Points

Auto mode and dual set points can be set by wired controller with bi-directional communication function. In auto mode, the indoor unit will operate in heating mode or cooling mode according to the indoor ambient temperature and target set temperature. When auto mode is set, cooling mode temperature compensation and heating mode temperature compensation is no longer has any effect.

Figure 3-8.2: Auto mode and dual set points

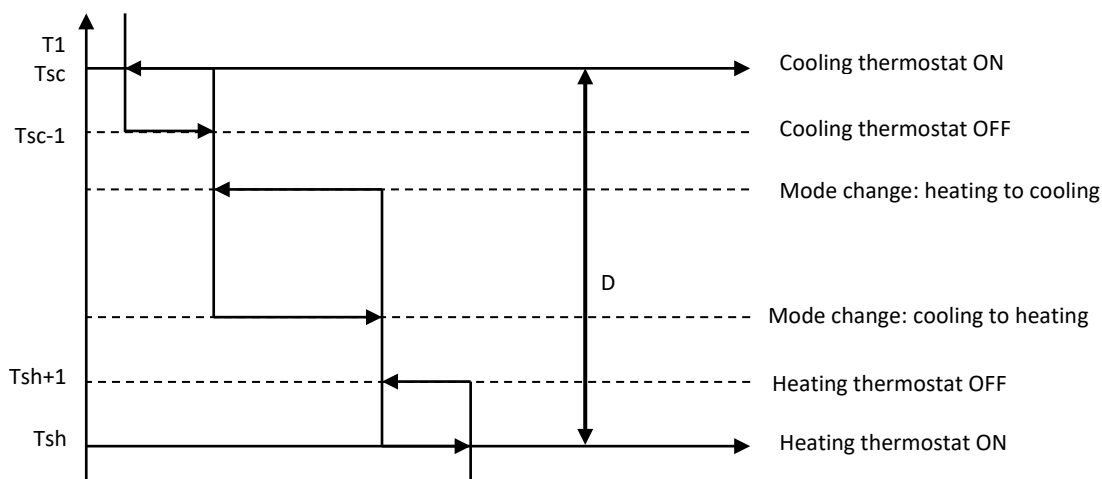

Tsc: Cooling target set temperature, 26°C default

Tsh: Heating target set temperature, 24°C default

$D = Tsc - Tsh$

There are three situations according to different D value. Take heating for example:

a) $D = 0^{\circ}\text{C}$

When the indoor ambient temperature ($T1$) is below Tsh , the indoor unit run in heating mode.

When the indoor ambient temperature ($T1$) is arrives $Tsh + 1^{\circ}\text{C}$, the indoor unit is heating thermostat OFF.

When the indoor ambient temperature ($T1$) is arrives $Tsh + 2^{\circ}\text{C}$, the indoor unit is cooling thermostat ON.

Case 1:

$Tsc = Tsh = 26^{\circ}\text{C}$

If the indoor unit operates cooling mode and when indoor ambient drops to 24°C , the indoor unit will change to heating mode; if the indoor unit operates heating mode and when indoor ambient rises to 28°C , the indoor unit will change to cooling mode. It is illustrated in Figure3-8.3.

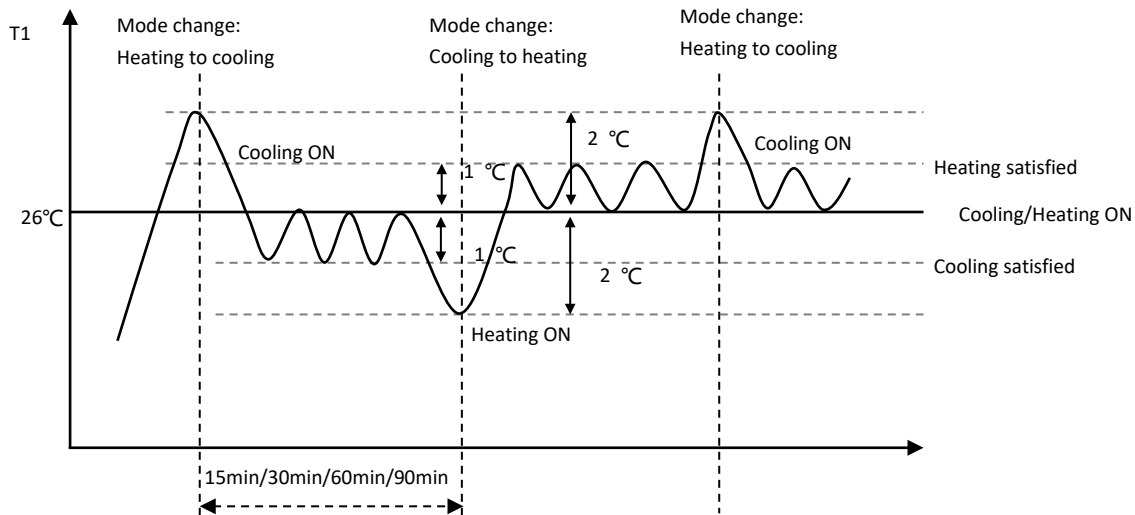
Figure 3-8.3: Case 1: $T_{sh}=T_{sc}$

b) $0 < T_{sc} - T_{sh} < 3^{\circ}\text{C}$

When the indoor ambient temperature (T_1) is below T_{sh} , the indoor unit runs in heating mode.

When the indoor ambient temperature (T_1) reaches $T_{sh} + 1^{\circ}\text{C}$, the indoor unit's heating thermostat turns OFF.

When the indoor ambient temperature (T_1) reaches $T_{sc} + 1.5^{\circ}\text{C}$, the indoor unit's cooling thermostat turns ON.

Case 2:

$T_{sc} = 26^{\circ}\text{C}$, $T_{sh} = 24^{\circ}\text{C}$

If the indoor unit operates in cooling mode and when the indoor ambient drops to 24.5°C , the indoor unit will change to heating mode; if the indoor unit operates in heating mode and when the indoor ambient rises to 27.5°C , the indoor unit will change to cooling mode.

c) $T_{sc} - T_{sh} \geq 3^{\circ}\text{C}$

When the indoor ambient temperature (T_1) is below T_{sh} , the indoor unit runs in heating mode.

When the indoor ambient temperature (T_1) reaches $T_{sh} + 1^{\circ}\text{C}$, the indoor unit's heating thermostat turns OFF.

When the indoor ambient temperature (T_1) reaches T_{sc} , the indoor unit's cooling thermostat turns ON.

Case 3:

$T_{sc} = 26^{\circ}\text{C}$, $T_{sh} = 22^{\circ}\text{C}$

If the indoor unit operates in cooling mode and when the indoor ambient drops to 22°C , the indoor unit will change to heating mode; if the indoor unit operates in heating mode and when the indoor ambient rises to 26°C , the indoor unit will change to cooling mode.

The default minimum time requirement for mode change is 15min. 30min, 60min and 90min can be set by a wired controller with bi-directional communication function.

8.5 Low Noise Mode

Low noise mode is used to decrease the noise produced by outdoor units. There are 3 kinds of low noise mode: night silent mode, silent mode and super silent mode. When low noise mode activating, both the fan step and compressor are limited. In order to maintain the reliability of TVR ULTRA HR system, the lowest fan step for inverter module temperature protection is prior to low noise control.

Table 3-8.4: Low noise mode

ODU	Night silent mode		Silent mode		Super silent mode	
	Max. Fan step	Max. frequency step	Max. Fan step	Max. frequency step	Max. Fan step	Max. frequency step
8HP	22	Cooling mode 59 Heating mode 68	22	Cooling mode 59 Heating mode 68	19	Cooling mode 52 Heating mode 52
10HP	23	Cooling mode 67 Heating mode 78	23	Cooling mode 67 Heating mode 78	20	Cooling mode 56 Heating mode 56
12HP	24	Cooling mode 72 Heating mode 80	24	Cooling mode 72 Heating mode 80	21	Cooling mode 64 Heating mode 72
14HP	22	Cooling mode 90 Heating mode 106	22	Cooling mode 90 Heating mode 106	19	Cooling mode 77 Heating mode 86
16HP	23	Cooling mode 90 Heating mode 118	23	Cooling mode 90 Heating mode 118	20	Cooling mode 79 Heating mode 106
18HP	24	Cooling mode 102 Heating mode 120	24	Cooling mode 102 Heating mode 120	21	Cooling mode 90 Heating mode 109
20HP	22	Cooling mode 59 Heating mode 68	22	Cooling mode 59 Heating mode 68	19	Cooling mode 52 Heating mode 52

8.6 Power Limitation Mode

The energy saving mode is used to limit the system power. It can be used to limit the line selection current or to reduce the peak current.

Table 3-8.5: Power limitation mode

Power limitation mode setting	Power limitation mode level	Correction factor
n41	Level 1 (Default)	100%
n42	Level 2	90%
n43	Level 3	80%
n44	Level 4	70%
n45	Level 5	60%
n46	Level 6	50%
n47	Level 7	40%

Part 4

Field Settings

1 Outdoor Unit Field Settings	52
2 Mode Selection Box Field Settings	55

1 Outdoor Unit Field Settings

1.1 PCB Switches and Switch Settings

Figure 4-1.1: Outdoor unit main PCB switches

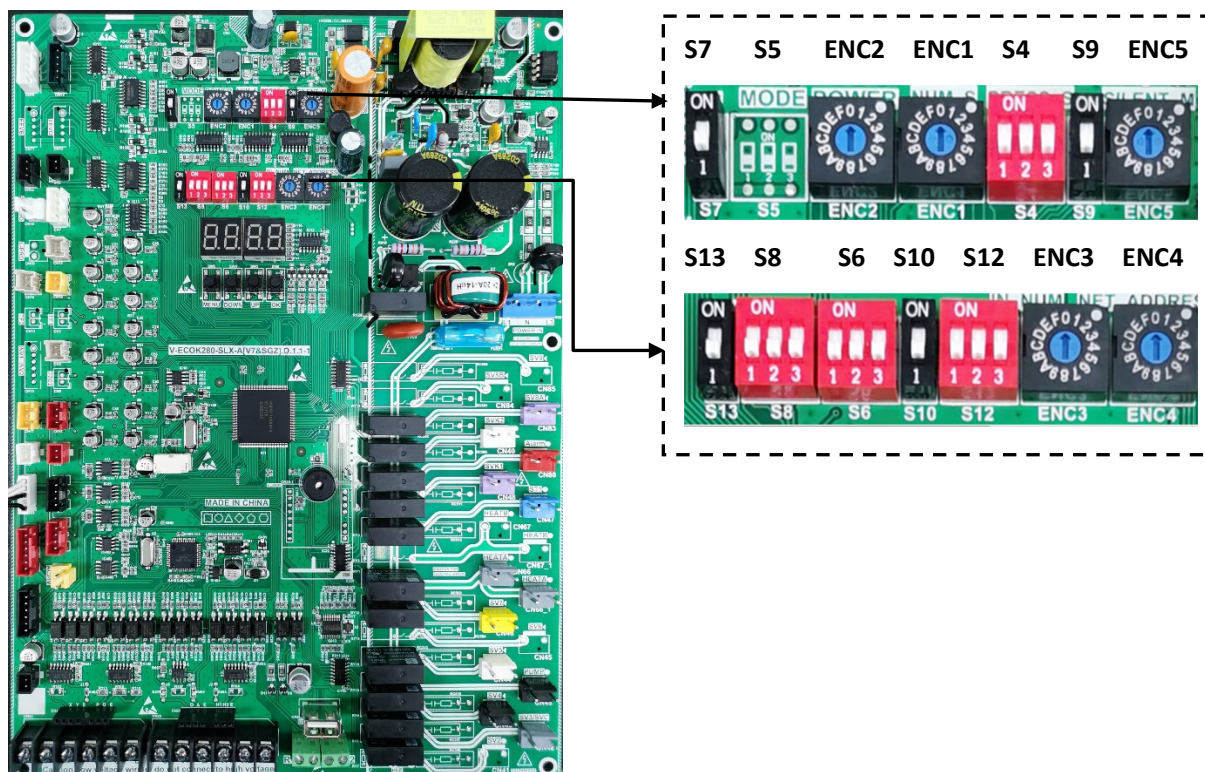

Table 4-1.1: Outdoor unit main PCB switch settings

Switch	Setting	Switch positions ¹	Description
 S4	Static pressure	 1 2 3	Standard static pressure (default, 0Pa)
		 1 2 3	Low static pressure mode (20Pa)
		 1 2 3	Medium static pressure mode (40Pa)
		 1 2 3	High static pressure mode (60Pa)
		 1 2 3	Super high static pressure mode (80Pa)
 S6-1	Reserved	 1 2 3	Reserved
 S6-2	Continuous heating ²	 1 2 3	Only reverse cycle defrosting is allowed (default)
		 1 2 3	Continuous heating and reverse cycle defrosting are allowed
 S6-3	Reserved	 1 2 3	Reserved
 S7	Reserved	 1	Reserved

Table continued on next page ...

Table 4-1.1: Outdoor unit main PCB switch settings (continued)

Switch	Setting	Switch positions ¹	Description
S8-1	Reserved		Reserved
S8-2	Start-up time		Start-up time is 12 minutes (default)
			Start-up time is 7 minutes
S8-3	Reserved		Reserved
S9	Auto dust-clean		No auto dust-clean (default)
			Auto dust-clean
S10	Force cooling		No force commissioning (default)
			Force commissioning
S13	Reserved		Reserved
ENC1	Outdoor unit address		Outdoor unit address setting. Only 0, 1, 2 should be selected (default is 0), 0 is for master unit; 1, 2 are for slave units.
ENC2	Outdoor unit capacity ³		Outdoor unit capacity setting. Only 0 to 6 should be selected, 0 to 6 are for 8HP to 20HP.
ENC4	Network address		Outdoor unit network address setting. Only 0 to 7 should be selected. (default is 0)
ENC3 S12	Number of indoor units		The number of indoor units is in the range 0-15 0-9 on ENC3 indicate 0-9 indoor units; A-F on ENC3 indicate 10-15 indoor units
			The number of indoor units is in the range 16-31 0-9 on ENC3 indicate 16-25 indoor units; A-F on ENC3 indicate 26-31 indoor units
			The number of indoor units is in the range 32-47 0-9 on ENC3 indicate 32-41 indoor units; A-F on ENC3 indicate 42-47 indoor units
			The number of indoor units is in the range 48-63 0-9 on ENC3 indicate 48-57 indoor units; A-F on ENC3 indicate 58-63 indoor units
			The number of indoor units is 64 0 on ENC3 indicate 64 indoor units
ENC5	Silent mode ⁴	0	Night silent time is 6h/10h
		1	Night silent time is 6h/12h
		2	Night silent time is 8h/10h
		3	Night silent time is 8h/12h
		4	No silent mode (default)
		8	Silent mode
		A	Super silent mode
		F	Set silent mode via centralized controller

Notes:

- Black denotes the switch position.
- This function is only available when the indoor units connected in TVR Ultra HR system are 2nd generation AC TVR indoor units (which will be released soon) or 2nd generation DC TVR indoor units produced after May 31st, 2020 only (The package of upgraded indoor units will add yellow label on both sides to distinguish the indoor units before and after the upgrade).
- Switch ENC2 is factory-set and its setting should not be changed.
- Refer to Part 4, 1.2.2 "Silent mode setting".

1.2 Modes Set on Main PCB

1.2.1 Night silent mode setting

Night silent mode is activated X hours after the peak daytime temperature, and is deactivated after Y hours, where X and Y are as specified in Table 4-1.2.

Table 4-1.2: Night silent time setting

Switch	Switch positions	Description	X	Y
 ENC5	0	Night silent time is 6h/10h (default)	6	10
	1	Night silent time is 6h/12h	6	12
	2	Night silent time is 8h/10h	8	10
	3	Night silent time is 8h/12h	8	12

Figure 4-1.2: Night silent mode example (default setting, 6h/10h)



1.2.2 Silent mode setting

Different silent mode can be set by switch ENC5. In night silent mode, silent mode and super silent mode, the Max. outdoor fan speed and the compressor frequency are limited.

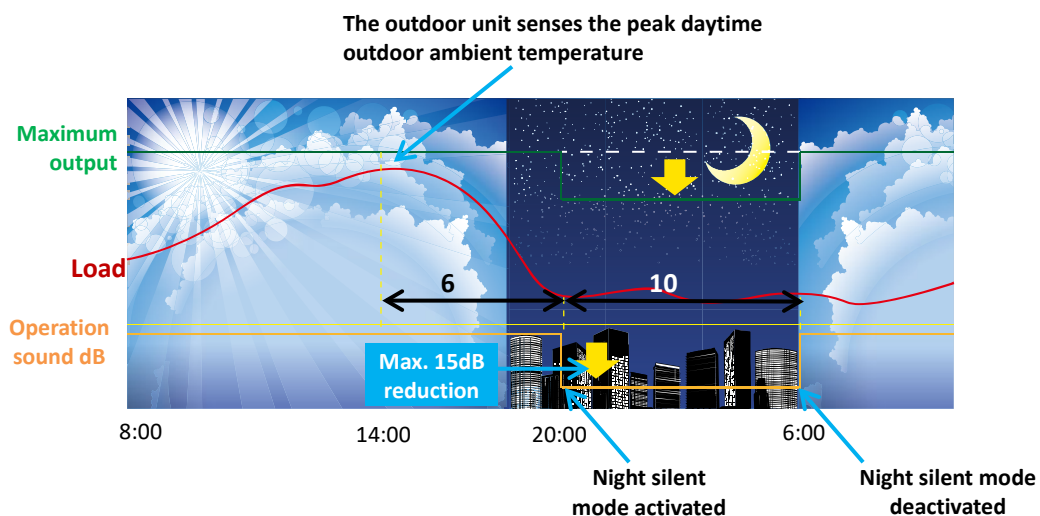
Table 4-1.3: Silent mode setting

Switch	Switch positions	Description
 ENC5	8	Silent mode (limit max. fan speed and compressor frequency)
	A	Super silent mode (limit max. fan speed and compressor frequency)
	F	Set silent mode via centralized controller

Notes:

1. Max. fan speed and compressor frequency refers to Table 3-8.3 in Part 3, 8.4 "Silent Mode".

2 Mode Selection Box Field Settings

2.1 MS01 Switches Settings

Figure 4-2.1: MS01 PCB switches

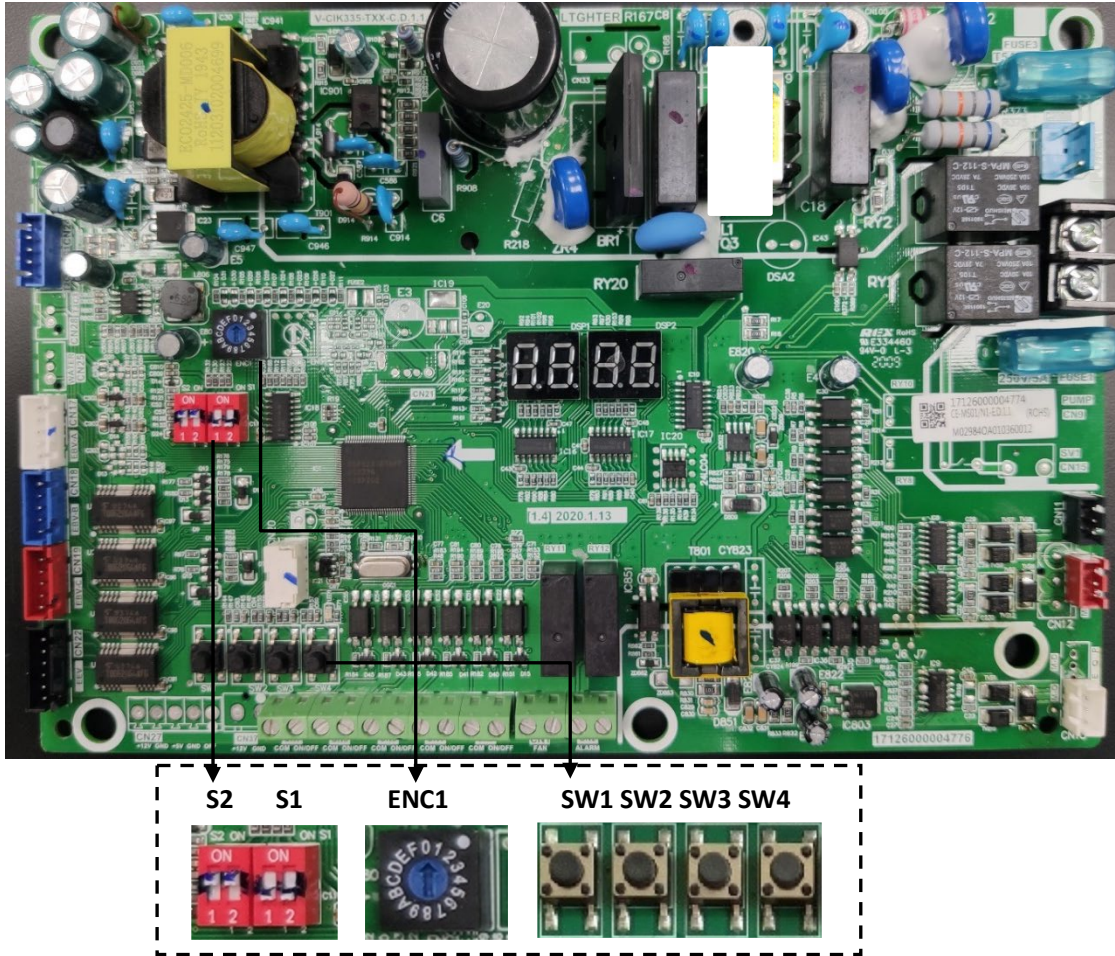















Table 4-2.1: MS01 PCB switch settings

Switch	Setting	Switch positions ¹	Description
S1-1 	Refrigerant leakage function setting		Refrigerant leakage function invalid (default)
			MS01 connected to refrigerant leakage sensor
S1-2 	Dry contact setting		Dry contact is always closed, and opened when being triggered by refrigerant leakage (default)
			Dry contact is always opened, and closed when being triggered by refrigerant leakage
S2-1 	Low temperature cooling function		Low temperature cooling function valid (default)
			Low temperature cooling function invalid
S2-2 	Reserved		Reserved
ENC1 	Refrigerant leakage sensors number		Number of refrigerant leakage sensors

2.2 MS04-12 Switches Settings

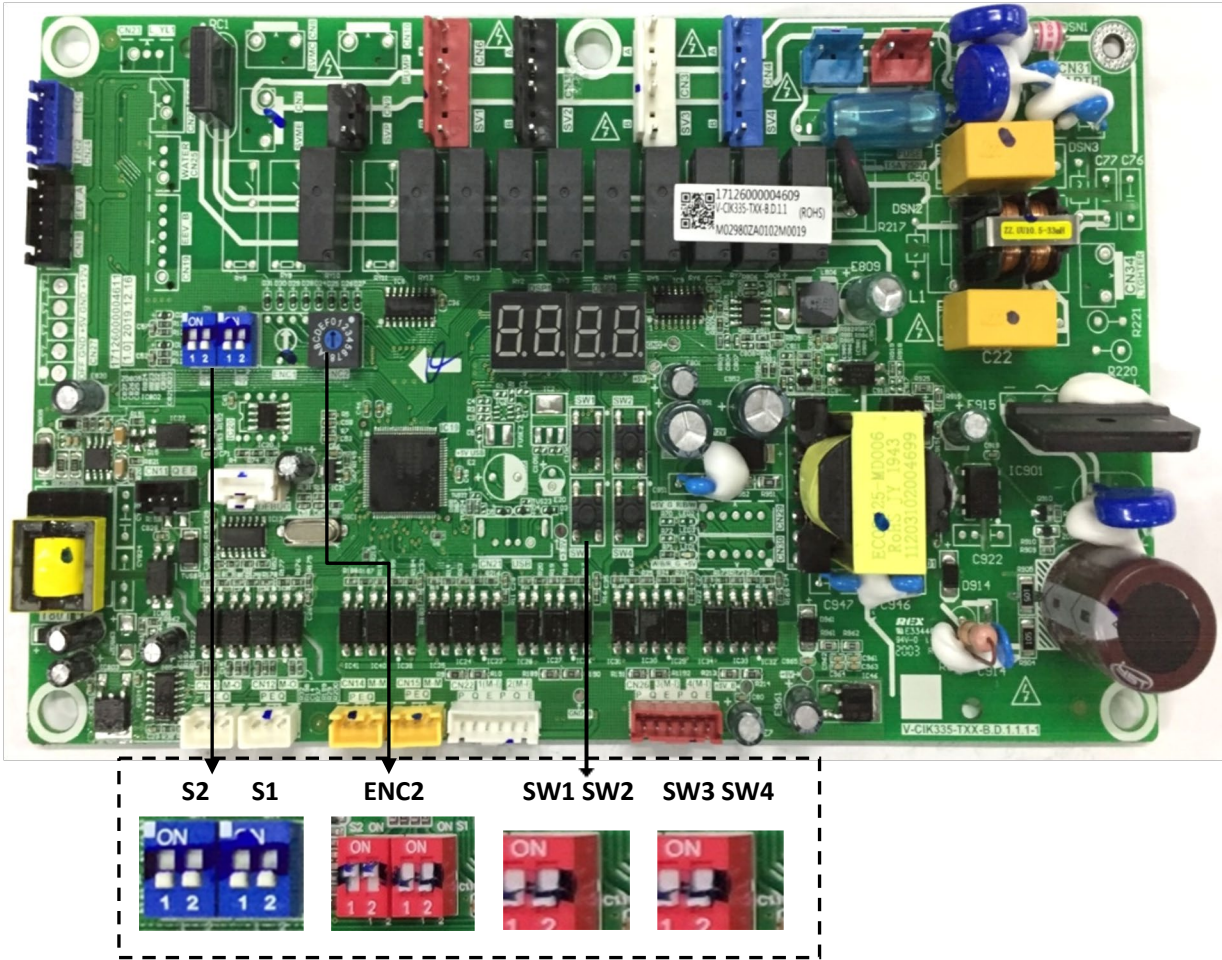

Table 4-2.1: MS04-12 PCB switch settings

Switch	Setting	Switch positions ¹	Description
	synchronous control setting		No synchronous control for 2 ports (default)
			synchronous control for 2 ports (First PCB is port 1 and 2, Second PCB is port 5 and 6, third PCB is port 9 and 10)
	synchronous control setting		No synchronous control for 2 ports (default)
			synchronous control for 2 ports (First PCB is port 3 and 4, Second PCB is port 7 and 8, third PCB is port 11 and 12)
	MS PCB number	0	The first PCB of MS box (Factory setting, can't be changed.)
		1	The second PCB of MS box (Factory setting, can't be changed.)
		2	The third PCB of MS box (Factory setting, can't be changed.)

Notes:

- The switch S1 and S2 must be either 00 or 11.

2.3 Manually Address Setting

The MS unit can perform automatic addressing based on ODU instructions. Automatic address setting is default. Refer to Part 5, 2.2.3 “Menu mode”.

Press SW3 for 3s on the MS box first PCB (ENC2 switches positions “0”). The digital display displays “-1MS” and “MS” is flashing, the number “-1” indicating the MS address. When the MS address flashes, press SW1 and SW2 to set the MS address within the range of 0 -63. After that, press and hold SW3 for 3s to confirm the settings.

Part 5

Electrical Components and Wiring Diagrams

1 Outdoor Unit Electric Control Box Layout	58
2 Outdoor Unit Main PCB	60
3 Data Transfer Module	68
4 Compressor Inverter Module	70
5 Fan Module	74
6 Mode Selection Box Main PCB	75
7 Wiring Diagrams	78

1 Outdoor Unit Electric Control Box Layout

8-12HP

Figure 5-1.1: 8-12HP top layer of electric control box

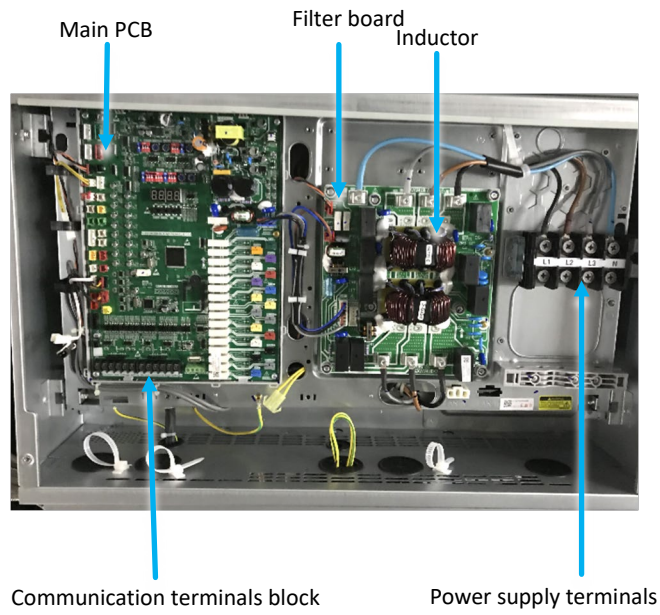

Figure 5-1.2: 8-12HP bottom layer of electric control box

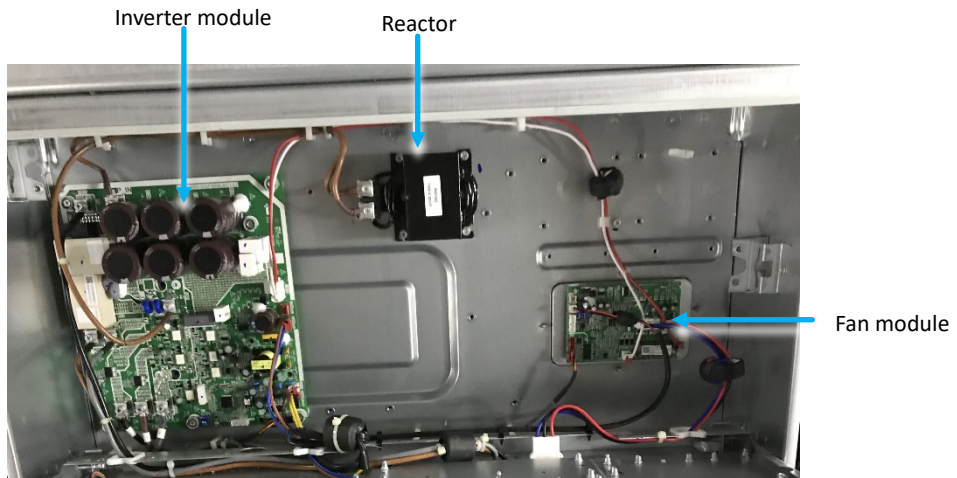

Figure 5-1.3: 14-20HP top layer of electric control box

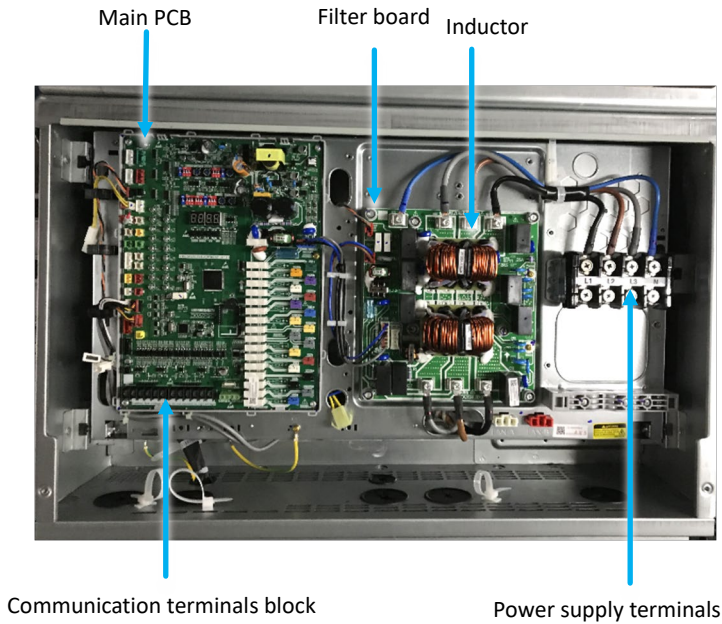
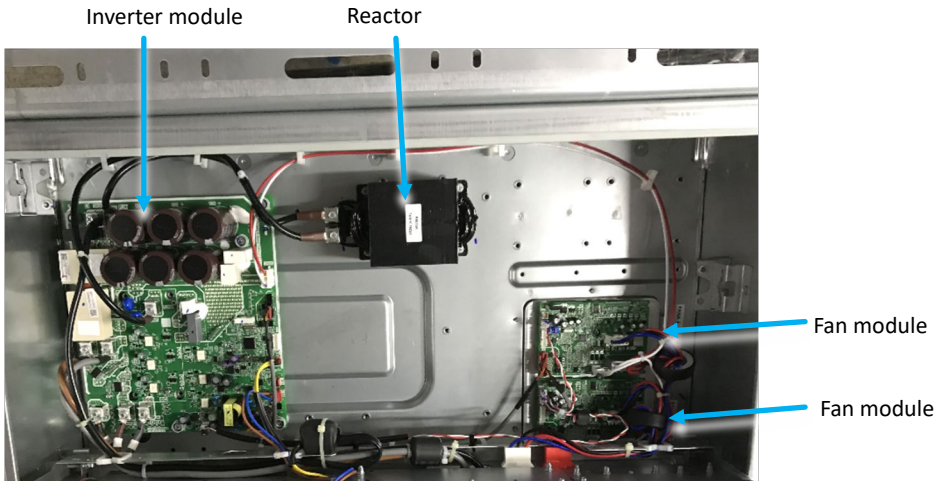

Figure 5-1.4: 14-20HP bottom layer of electric control box



2 Outdoor Unit Main PCB

2.1 Ports

Figure 5-2.1: Outdoor unit main PCB ports¹

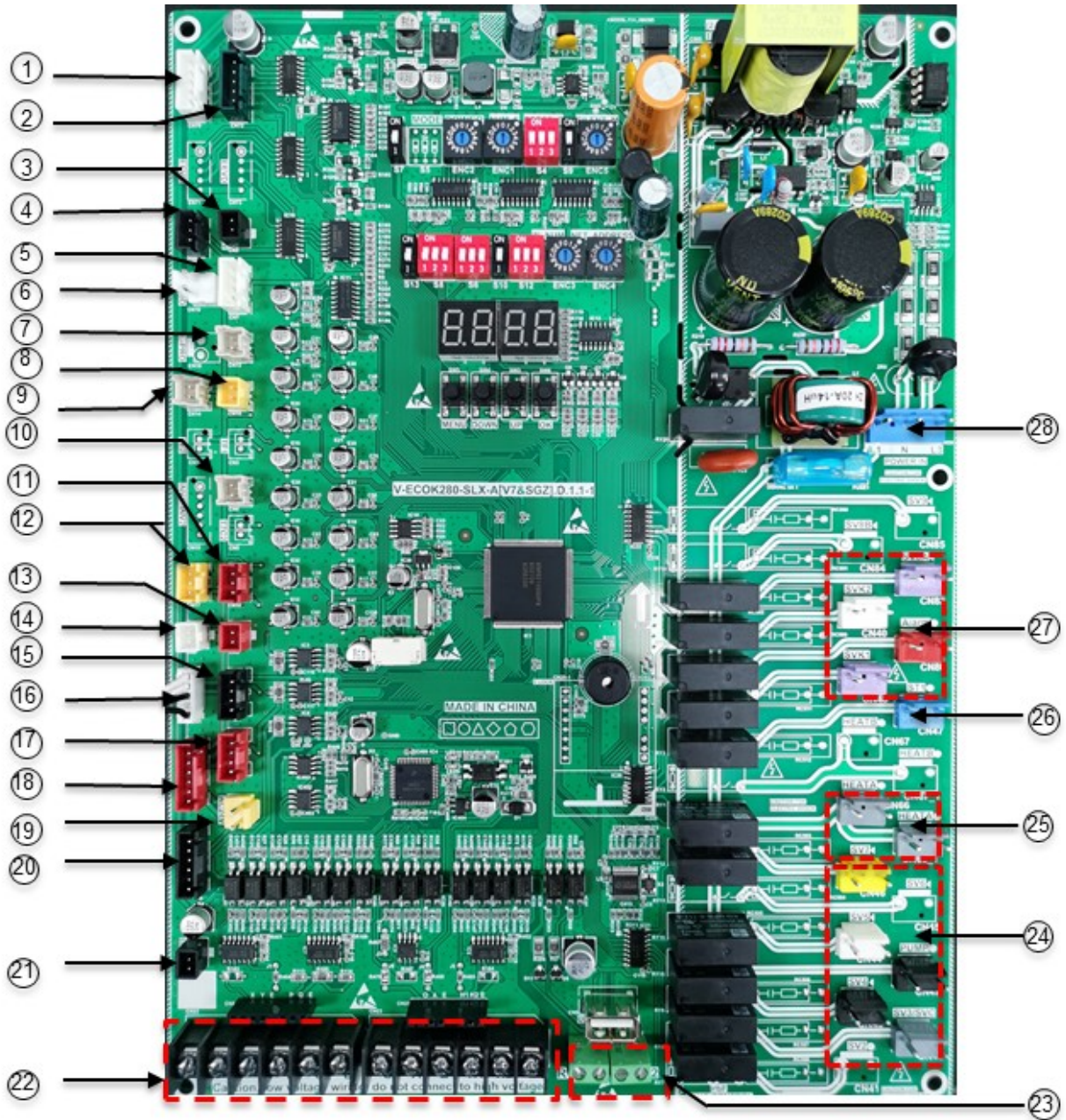

Notes:

1. Label descriptions are given in Table 5-2.1.

Table 5-2.1: Main PCB port

Label in Figure 5-2.1	Port code	Content	Port voltage
1	CN70	EXVA drive port	0V or 12V DC
2	CN72	EXVC drive port	0V or 12V DC
3	CN2	Reserved	12V DC
4	CN82	Control port of relay for AC filter board	0V or 12V DC
5	CN7	Heat exchanger gas temperature sensor(T8) connection, Heat exchanger liquid temperature sensor(TL) connection	0-5V DC (varying)
6	CN18	High pressure switch and discharge temperature switch(es) connections	0V or 5V DC
7	CN12	Liquid pipe temperature sensor(T5) connection	0-5V DC (varying)
8	CN10	Suction temperature sensor(T7) connection	0-5V DC (varying)
9	CN14	Heat sink temperature sensor(T9) connection	0-5V DC (varying)
10	CN4	Compressor Discharge temperature sensor(T7C1) connection	0-5V DC (varying)
11	CN16	Low pressure sensor connection	0-5V DC (varying)
12	CN17	High pressure sensor connection	0-5V DC (varying)
13	CN6	Subcooling gas temperature sensor(T6B) connection	0-5V DC (varying)
14	CN8	Injection liquid temperature sensor(T6A) connection	0-5V DC (varying)
15	CN26	Communication port to compressor drive board	2.5-2.7V DC
16	CN1	Outdoor ambient temperature sensor and outdoor heat exchanger temperature sensor connections	0-5V DC (varying)
17	CN27	Communication port to fan drive board	2.5-2.7V DC
18	CN31	Reserved	0-5V DC
19	CN21	Reserved	24V AC
20	CN28	Communication port to Network converter assembly	0-12V DC
21	CN11	Reserved	5V DC
22	CN22/CN23	Communication port	2.5-2.7V DC
23	CN91/CN92	Emergency stop port	0V or Open
24	CN42-CN44 CN46/CN49	Solenoid valve drive ports	220V AC
25	CN66/CN66-1	Power supply to compressor crankcase heater	220V AC
26	CN47	Four-way valve drive ports	220V AC
27	CN40/CN47/CN48 /CN80/CN83	Solenoid valve drive ports	220V AC
28	CN30	Power input of main board	220V AC between L1/L3 and N 380V AC between L1 and L3

2.2 Components

2.2.1 Layout

Figure 5-2.2: Outdoor unit main PCB components

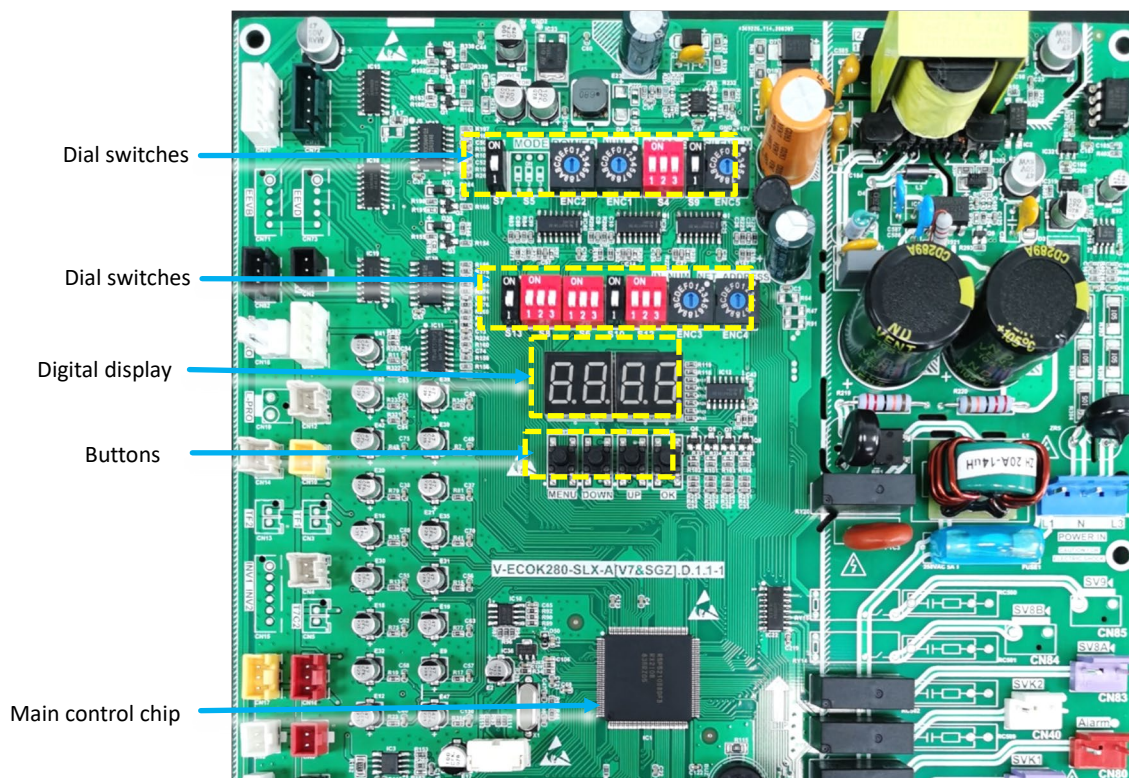

2.2.2 Function of buttons SW3 to SW6

Table 5-2.2: Function of buttons SW3 to SW6

Button	Function
SW3 (UP)	In menu mode: previous and next buttons for menu modes. Not in menu mode: previous and next buttons for system check information.
SW4 (DOWN)	
SW5 (MENU)	Enter / exit menu mode.
SW6 (OK)	Confirm to enter specified menu mode.



2.2.3 Menu mode

Only master unit has the full menu functions, slave units only have error codes check and cleaning functions.

1. Long press SW5 "MENU" button for 5 seconds to enter menu mode, and the digital display displays "n1";
2. Press SW3 / SW4 "UP / DOWN" button to select the first level menu "n1", "n2", "n3", "n4" or "nb";
3. Press SW6 "OK" button to enter specified first level menu, for example, enter "n4" mode;
4. Press SW3 / SW4 "UP / DOWN" button to select the second level menu from "n41" to "n47";
5. Press SW6 "OK" button to enter specified second level menu, for example, enter "n43" mode;

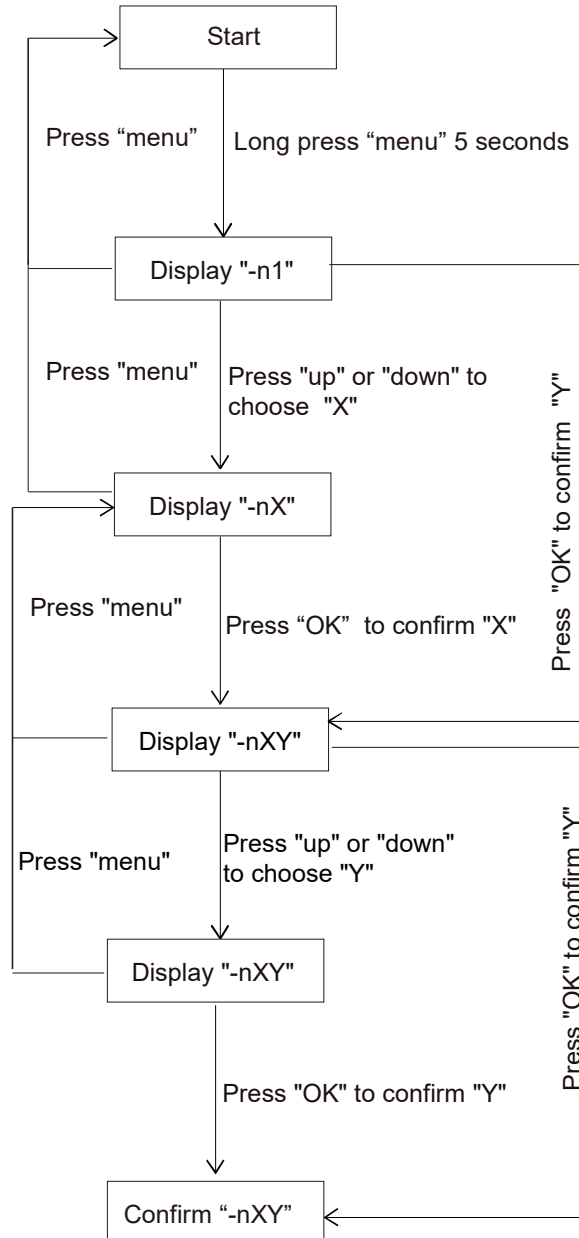
Menu mode selection flowchart:

Menu mode function:

Table 5-2.3: Menu mode function

Digital display content	Menu mode	Remarks
n11	Test operation	Only available for the master unit
n14	Cooling test	Only available for the master unit (all indoor units running in cooling mode)
n15	Heating test	Only available for the master unit (all the indoor units will run in heating mode. Once there is one or more old indoor unit in the system)
n16	Maintenance mode	Only available for the master unit, the system does not check the indoor units' number.
n17	Manual defrost	Only available for the master unit
n18	Automatic refrigerant diagnosis	Only available for the master unit
n21	Refrigerant recovery 1 (PUMP DOWN)	Only available for the master unit
n22	Refrigerant recovery 2 (PUMP OUT)	Only available for the master unit
n25	Auto refrigerant charging	Only available for the master unit
n27	Vacuum mode	Only available for the master unit
n31	History error codes	Display recent ten history error codes
n32	Cleaning history error codes	
n33	Fan software version	
n34	Factory reset (Except when snow blowing and reverse rotation for dust cleaning)	Only available for the master unit
n35	Release emergency stop	Only available for the master unit
n41	Power limitation mode 1	Only available for the master unit, 100% capacity output
n42	Power limitation mode 2	Only available for the master unit, 90% capacity output
n43	Power limitation mode 3	Only available for the master unit, 80% capacity output
n44	Power limitation mode 4	Only available for the master unit, 70% capacity output
n45	Power limitation mode 5	Only available for the master unit, 60% capacity output
n46	Power limitation mode 6	Only available for the master unit, 50% capacity output
n47	Power limitation mode 7	Only available for the master unit, 40% capacity output
n91	Auto regulation of medium capacity (Tes0=6,default)	Only available for master unit (Te target temperature during cooling operation, Automatic control)
n92	Auto regulation of high capacity (Tes0=3)	Only available for master unit (Te target temperature during cooling operation, Automatic control)
n93	Auto regulation of low capacity (Tes0=9)	Only available for master unit (Te target temperature during cooling operation, Automatic control)
n94	Low locking capacity (Tes0=9)	Only available for master unit (Te target temperature during cooling operation, Automatic control)
n95	Medium-to-low locking capacity (Tes0=6)	Only available for master unit (Te target temperature during cooling operation, Locking)
n96	Medium locking capacity (Tes0=3)	Only available for master unit (Te target temperature during cooling operation, Locking)
n97	Medium-to-high locking capacity (Tes0=0)	Only available for master unit (Te target temperature during cooling operation, Locking)
n98	High locking capacity (Tes0=-3)	Only available for master unit (Te target temperature during cooling operation, Locking)
nA1	Auto regulation of medium capacity (Tcs0=48,default)	Only available for master unit (Tc target temperature during heating operation, Automatic control)
nA2	Auto regulation of high capacity (Tcs0=50)	Only available for master unit (Tc target temperature during heating operation, Automatic control)
nA3	Auto regulation of low capacity (Tcs0=45)	Only available for master unit (Tc target temperature during heating operation, Automatic control)

Table continued on next page ...

Table 5-2.3: Menu mode function (continued)

nA4	Low locking capacity (Tcs0=42)	Only available for master unit (Tc target temperature during heating operation, Automatic control)
nA5	Medium-to-low locking capacity (Tcs0=44)	Only available for master unit (Tc target temperature during heating operation, Locking)
nA6	Medium locking capacity (Tcs0=46)	Only available for master unit (Tc target temperature during heating operation, Locking)
nA7	Medium-to-high locking capacity (Tcs0=48)	Only available for master unit (Tc target temperature during heating operation, Locking)
nA8	High locking capacity (Tcs0=51)	Only available for master unit (Tc target temperature during heating operation, Locking)
nb1	Fahrenheit degree setting (°F)	Only available for the master unit
nb2	Celsius degree setting (°C)	Only available for the master unit
nb5	Auto snow-blowing mode 1	According to outdoor ambient temperature (T4), the outdoor fan(s) periodically stop for 15 minutes and run for 2 minute
nb6	Auto snow-blowing mode 2	According to outdoor ambient temperature (T4), the outdoor fan(s) periodically stop for 30 minutes and run for 2 minute
nb7	Exit auto snow-blowing mode	
nb8	VIP address setting	The digital display will display "IdXX", "XX" stands for VIP address, use UP / DOWN button to change the VIP address and press OK button to confirm the specified VIP address.
nC1	Reverse rotation for dust-clean.	When this function is activated, "ddOn" is displayed. When this function is disabled, "ddOF" is displayed.
nC2	Remote shut down setting	nC2=0: Remote shut down setting #1: System stops when the circuit (R-OFF1) is 'short'(default) nC2=1: Remote shut down setting #2: System stops when the circuit (R-OFF1) is 'open'
nC3	Start address for automatic addressing	Only available for the master unit
nC4	Auto addressing indoor units	Only available for the master unit
nC5	Display the online IDU address	Only available for the master unit
nC7	Clear IDU address and MS address	Only available for the master unit
nE1	Refrigerant leakage protection function 1	Only available for the master unit
nE2	Refrigerant leakage protection function 2	Only available for the master unit
nE3	Refrigerant leakage protection function 3	Only available for the master unit

Te: Low pressure equivalent saturation temperature (°C) Tes: Target Te value.

Tc: High pressure equivalent saturation temperature (°C) Tcs: Target Tc value.

How to exit specified menu mode:

Table 5-2.4: Exit specified menu mode method:

Menu mode	Manual exit method	Automatic exit method	System restart
Debug mode 1 (2)	Long press SW6 "OK" button when the digital display is not in menu selection state	After running 120 minutes	Invalid
Maintenance mode	/	After running 180 minutes	Invalid
Vacuum mode	Long press SW6 "OK" button when the digital display is not in menu selection state	After running 8 hours	Invalid
Power limitation mode	Select power limitation mode 1 "n41"	/	Valid
Auto snow-blowing mode 1 (2)	Select "nb7"	/	Valid
VIP address setting	/	/	Valid
°F / °C setting	/	/	Valid

2.2.4 UP / DOWN system check button

Before pressing UP or DOWN button, allow the system to operate steadily for more than an hour. On pressing UP or DOWN button, the parameters listed in Table 5-2.5 will be displayed in sequence.

Table 5-2.5: System check

DSP content	Parameters displayed on DSP2	Remarks
----	Standby (ODU address + IDU Qty.)/frequency/particular state	
0.--	Unit address	Master unit: 0; slave units: 1, 2
1.--	Single module capacity	8-20HP
2.--	Number of outdoor units	Displayed on master unit PCB only
3.--	Number of indoor units as set on PCB	Displayed on master unit PCB only
4.--	Total capacity of outdoor unit	Only available for master unit, displayed on slave units has no sense
5.--	Single module compressor frequency	Displayed on master unit PCB only
6.--	System compressor frequency	Actual value = value displayed × 10
7.--	System operating mode	0: off; 2: cooling; 3: heating; 4: main heating; 5: main cooling.
8.--	Fan A speed index	Refer to Note 1
9.--	Fan B speed index	Refer to Note 1
10.--	Indoor heat exchanger pipe (T2) temperature (°C)	Actual value = value displayed
11.--	Indoor heat exchanger pipe (T2B) temperature (°C)	Actual value = value displayed
12.--	Main heat exchanger pipe (T3) temperature (°C)	Actual value = value displayed
13.--	Outdoor ambient (T4) temperature (°C)	Actual value = value displayed
14.--	Outdoor liquid pipe (T5) temperature (°C)	Actual value = value displayed
15.--	Plate heat exchanger cooling refrigerant inlet (T6A) temperature (°C)	Actual value = value displayed
16.--	Plate heat exchanger cooling refrigerant outlet (T6B) temperature (°C)	Actual value = value displayed
17.--	Inverter compressor discharge (T7C1) temperature (°C)	Actual value = value displayed
18.--	Outdoor heat exchanger gas pipe (T5) temperature (°C)	Actual value = value displayed
19.--	Compressor inverter module internal (Ntc) temperature (°C)	Actual value = value displayed
20.--	Inverter module heatsink (T9)temperature (°C)	Actual value = value displayed
21.--	Outdoor heat exchanger liquid pipe (TL) temperature (°C)	Actual value = value displayed
22.--	Compressor suction (T7) temperature (°C)	Actual value = value displayed
23.--	Discharge superheat degree (°C)	Actual value = value displayed
24.--	Primary current (A)	Actual value = value displayed
25.--	EXVA position	Actual value = value displayed × 24
26.--	EXVC position	Actual value = value displayed × 4
27.--	Compressor discharge pressure (MPa)	Actual value = value displayed × 0.1
28.--	Compressor suction pressure (MPa)	Actual value = value displayed × 0.01
29.--	Number of indoor units currently in communication with master unit	Displayed on master unit PCB only
30.--	Number of indoor units currently operating	Displayed on master unit PCB only
31.--	Heat exchanger status	0-OFF; 1-Condenser; 2-Condenser (Not used); 3-Evaporator; 4-Evaporator (Not used)
32.--	System startup status	2~4-Startup control; 6-PI control;
33.--	Silent mode	Refer to Note 2
34.--	Static pressure mode	0: 0 Pa; 1: 20Pa; 2: 40Pa; 3: 60Pa; 4: 80Pa.
35.--	TES(°C)	Actual value = value displayed
36.--	TCS(°C)	Actual value = value displayed - 25
37.--	DC voltage A	Actual value = value displayed × 10
38.--	AC voltage B	Actual value = value displayed × 2
39.--	Number of indoor units for cooling operation	Actual value = value displayed
40.--	Number of indoor units for heating operation	Actual value = value displayed
41.--	Number of high temperature hydronic modules running	Actual value = value displayed
42.--	Total capacity of indoor units for cooling operation	
43.--	Total capacity of indoor units for heating operation	
44.--	Total capacity of high temperature hydro modules running	
45.--	Fan's failure history	
46.--	Software version	
47.--	Power limitation mode settings	
48.--	Reserved	
49.--	Reserved	
50.--	Reserved	
51.--	Most recent error or protection code	"--" is displayed if no error or protection events have occurred since start-up
-- --	--	End

Notes:

- The fan speed index is related to the fan speed in rpm and can take any integer value in the range 1 (slowest) to 30 (fastest).
- Silent mode:
 - 0: night silent time 6h/10h; 1: night silent time 6h/12h; 2: night silent time 8h/10h; 3: night silent time 8h/12h; 4: no silent mode; 5: silent mode; 6: super silent mode.
- Te: Low pressure equivalent saturation temperature (°C) Tes: Target Te value. Tc: High pressure equivalent saturation temperature (°C) Tcs: Target Tc value.

2.2.5 Digital display output

Table 5-2.6: Digital display output in different operating states

Outdoor unit state		Parameters displayed on DSP1	Parameters displayed on DSP2
Standby		Unit's address	The number of indoor units in communication with the outdoor units
Normal operation	For single compressor units	--	Running speed of the compressor in rotations per second
Error or protection		-- or placeholder	Error or protection code
In menu mode		Refer to Table 5-2.3	Refer to Table 5-2.3
System check		Refer to Table 5-2.5	Refer to Table 5-2.5



DSP1

DSP2

3 Data Transfer Module

3.1 Layout

Data Transfer Module is an additional auxiliary small PCB installed on the side columns of the outdoor unit, this design greatly helps the installer or service man to set Auto-commissioning or CHECK the operation status without removing the front panel.

Figure 5-3.1: Data Transfer Module layout

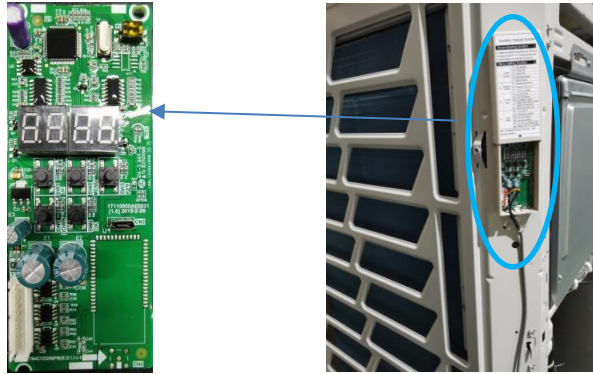

3.2 PCB components

Figure 5-3.2: Data Transfer Module PCB components

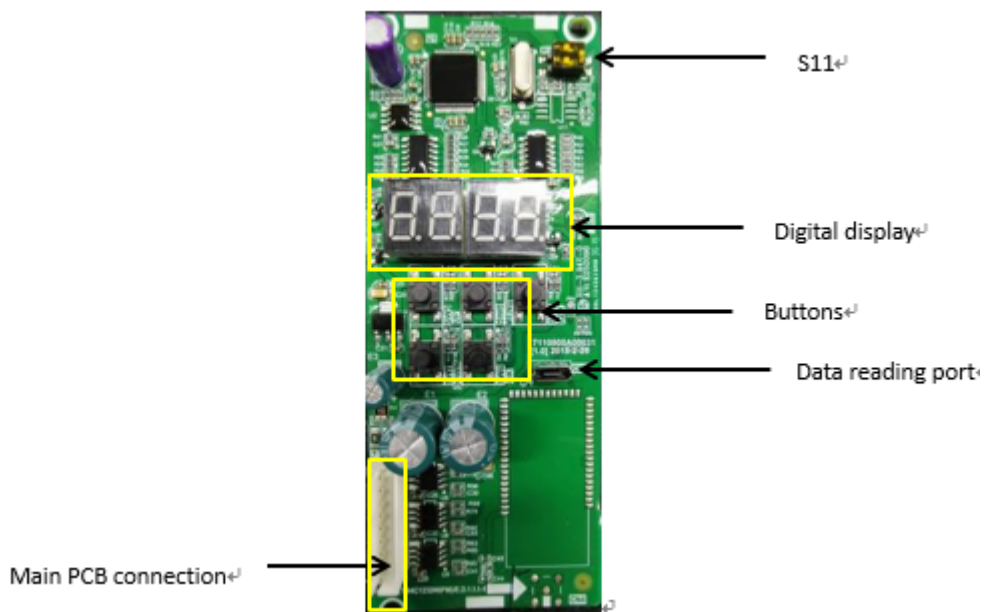

3.3 Main functions

- | | | | | | | |
|--------------|----------|---------------------------|------------------|--------------------|--------------|-------------------|
| | | | | | | |
| System check | Sync LED | Auto snow-blowing setting | Data acquisition | Fault data storage | Data reading | Menu mode setting |

3.3.1 System check

Press UP or DOWN button to enter system check mode, system check contents are same as the outdoor main PCB. Please refer to table 5-2.5.

3.3.2 Sync information from main PCB digital display

The digital display on data transfer module displays the same information as the digital display on main PCB.

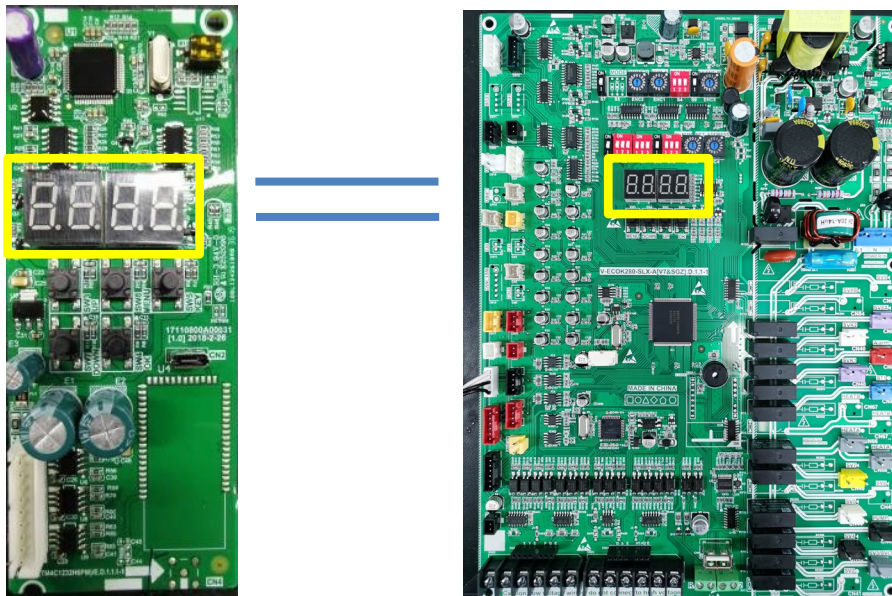

3.3.3 Auto snow-blowing setting

SW5 / S11: enter/exit auto snow-blowing mode (only available for the outdoor unit which has been customized auto-blowing function)

S11	Mode	Remark
	Auto snow-blowing mode 1 (customized)	According to outdoor ambient temperature (T4), the outdoor fan(s) periodically stop for 15 minutes and run for 2 minute
	Auto snow-blowing mode 2 (customized)	According to outdoor ambient temperature (T4), the outdoor fan(s) periodically stop for 30 minutes and run for 2 minute

- When the outdoor unit is in standby mode, press SW5 (Key) button to enter auto snow-blowing mode 1 or 2 (depend on S11 setting), pressure SW5 (Key) button again to exit the auto snow-blowing mode. If the outdoor unit receive operation signal during auto snow-blowing mode, the outdoor unit exits the auto snow-blowing mode automatically.
- When the outdoor unit is operating, the auto snow-blowing function cannot be activated.

3.3.4 Data acquisition

Check all operating parameters at most 7.5min per time. The data transfer module does not store the normal operating parameters.

3.3.5 Fault data storage

The data transfer module can store 32 groups fault data. Every group fault data contains the error code and 5 groups operating data before the error code displayed.

3.3.6 Data reading

The stored fault data in the data transfer module can be read on new diagnosis software through data reading port on the data transfer module.

3.3.7 Menu mode setting

Through MENU, UP, DOWN and OK buttons to enter menu mode. The method to enter menu mode is same as the way through main PCB. The menu modes contents are same as the outdoor main PCB. Please refer to table 5-2.3.

4 Compressor Inverter Module

4.1 Ports

8-12HP

Figure 5-4.1: 8-12HP compressor inverter module ports¹

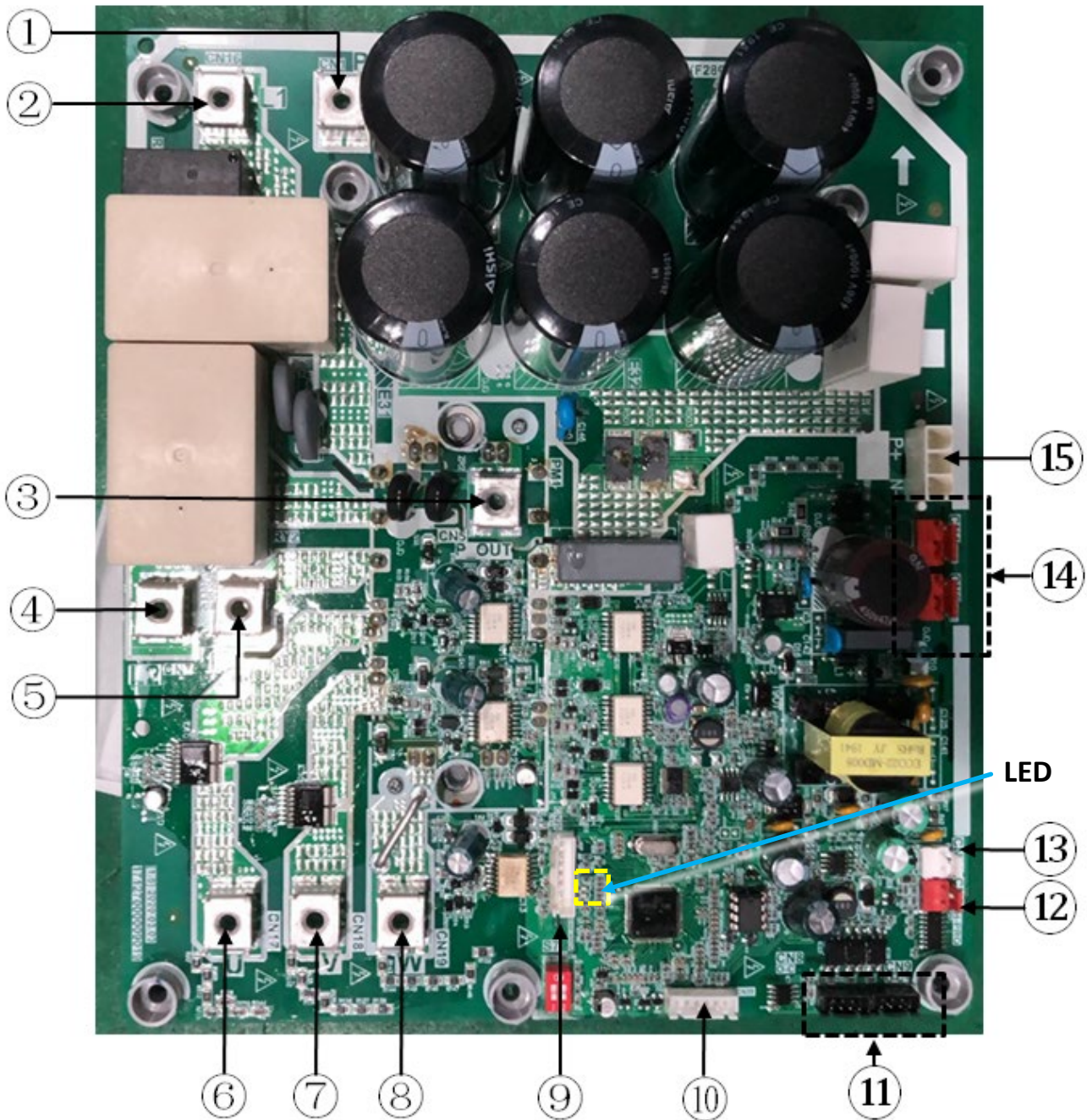

Notes:

1. Label descriptions are given in Table 5-4.1.

Table 5-4.1: 8-12HP compressor inverter module ports

Label in Figure 5-4.1	Code	Content	Port voltage
1	CN1	P-in connect to reactor	560V DC between P and N;
2	CN16	Three phase power input of L1	380V AC between L1/L2 and L3;
3	CN5	P-out connect to reactor	560V DC between P and N;
4	CN7	Three phase power input of L2	380V AC between L1/L2 and L3;
5	CN15	Three phase power input of L3	380V AC between L1/L2 and L3;
6	CN17	Three phase output of the inverter ,connected to the compressor	0-380V AC (varying)
7	CN18	Three phase output of the inverter ,connected to the compressor	0-380V AC (varying)
8	CN19	Three phase output of the inverter ,connected to the compressor	0-380V AC (varying)
9	CN25	Program port for main chip	/
10	CN39	Program port for parameters	/
11	CN8/CN9	Communication port to Main PCB	2.5-2.7V DC
12	CN21	High pressure switch connection	12V DC
13	CN20	Power supply terminal for DC fan inverter module	20V DC
14	CN4/CN6	AC power supply for inverter module	220V AC
15	CN38	Power supply terminal for DC fan inverter module (P,N)	560V DC

Figure 5-4.2: 14-20HP compressor inverter module ports¹

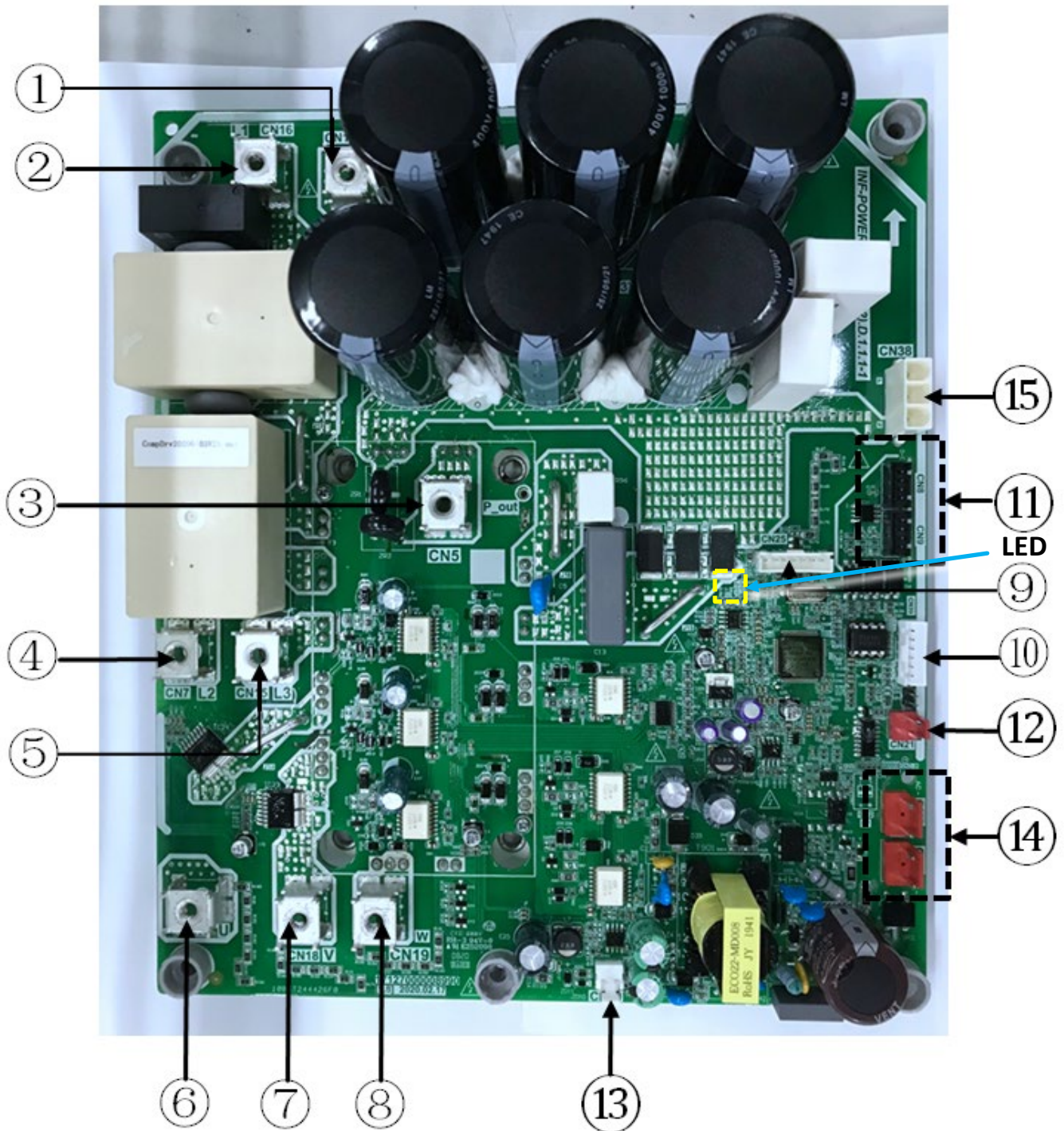

Notes:

1. Label descriptions are given in Table 5-4.2.

Table 5-4.2: 14-20HP compressor inverter module ports

Label in Figure 5-3.1	Code	Content	Port voltage
1	CN1	P-in connect to reactor	560V DC between P and N;
2	CN16	Three phase power input of L1	380V AC between L1/L2 and L3;
3	CN5	P-out connect to reactor	560V DC between P and N;
4	CN7	Three phase power input of L2	380V AC between L1/L2 and L3;
5	CN15	Three phase power input of L3	380V AC between L1/L2 and L3;
6	CN17	Three phase output of the inverter ,connected to the compressor	0-380V AC (varying)
7	CN18	Three phase output of the inverter ,connected to the compressor	0-380V AC (varying)
8	CN19	Three phase output of the inverter ,connected to the compressor	0-380V AC (varying)
9	CN25	Program port for main chip	/
10	CN39	Program port for parameters	/
11	CN8/CN9	Communication port to Main PCB	2.5-2.7V DC
12	CN21	High pressure switch connection	12V DC
13	CN20	Power supply terminal for DC fan inverter module	20V DC
14	CN4/CN6	AC power supply for inverter module	220V AC
15	CN38	Power supply terminal for DC fan inverter module (P,N)	560V DC

4.2 LED Indicators

Table 5-4.1: LED indicators LED1 and LED2

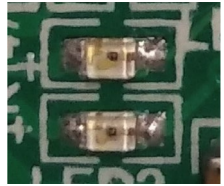
Indicator	LED indicator function and status	
LED 1	Inverter module operating indicator. Continuously on if the compressor is running normally and flashing if an inverter module error has occurred ¹ .	
LED 2	Inverter module error indicator. Continuously on if an inverter module error has occurred ¹ .	

Note:

1. If an inverter module error occurs, refer to Part 6, "H4 Troubleshooting". The error code is displayed on the digital display.

5 Fan Module

Figure 5-5.1: Fan module ports¹

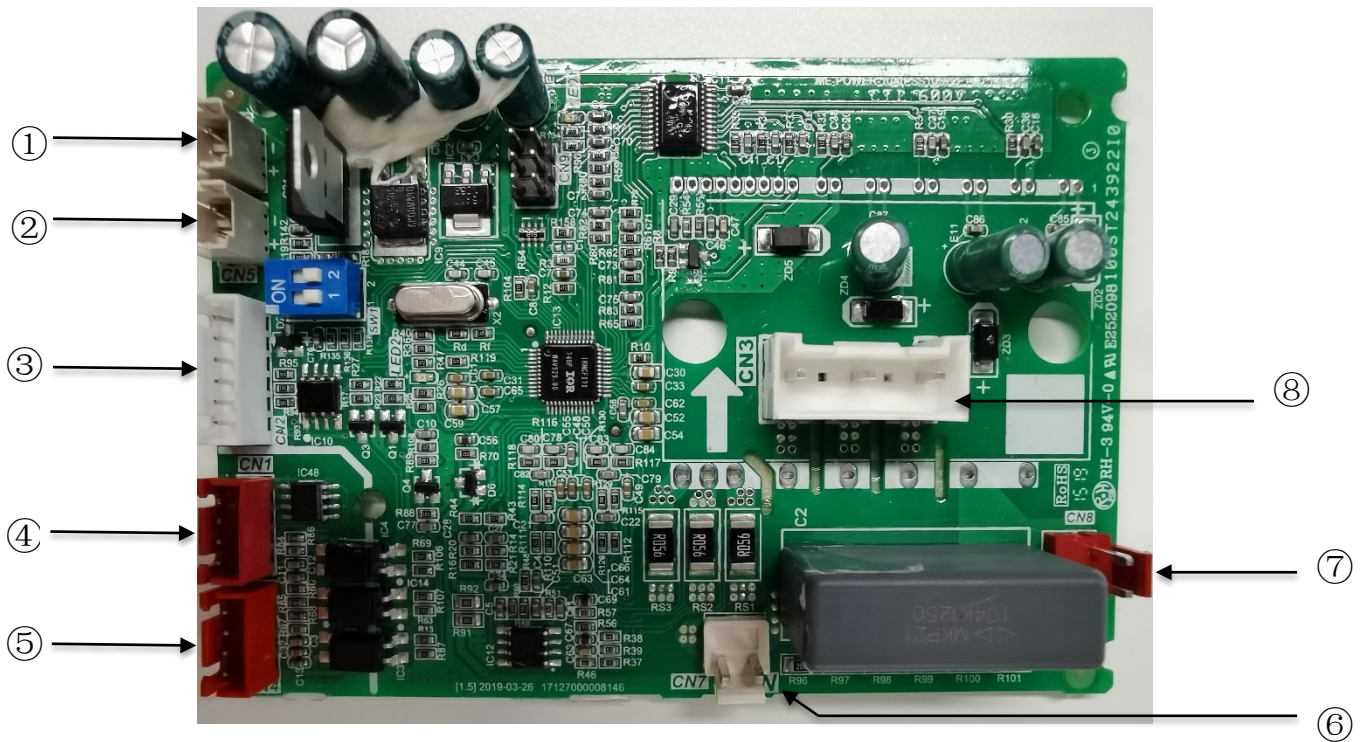

Notes:

1. Label descriptions are given in Table 5-5.1.

Table 5-5.1: Fan module ports

Label in Figure 5-4.1	Code	Content	Port voltage
1	CN6	Power input of DC fan drive board	18V-22V DC
2	CN5	Power input of DC fan drive board	18V-22V DC
3	CN2	Debug port	/
4	CN1	Communication port to main board	2.5-2.7V DC
5	CN4	Communication port to main board	2.5-2.7V DC
6	CN7	Power supply terminal for IPM	438-650V DC between P and N;
7	CN8	Power supply terminal for IPM	438-650V DC between P and N;
8	CN3	DC power supply for fan	0-380V AC (varying)

6 Mode Selection Box Main PCB

6.1 Ports

MS01

Figure 5-6.1: MS01 main PCB ports¹

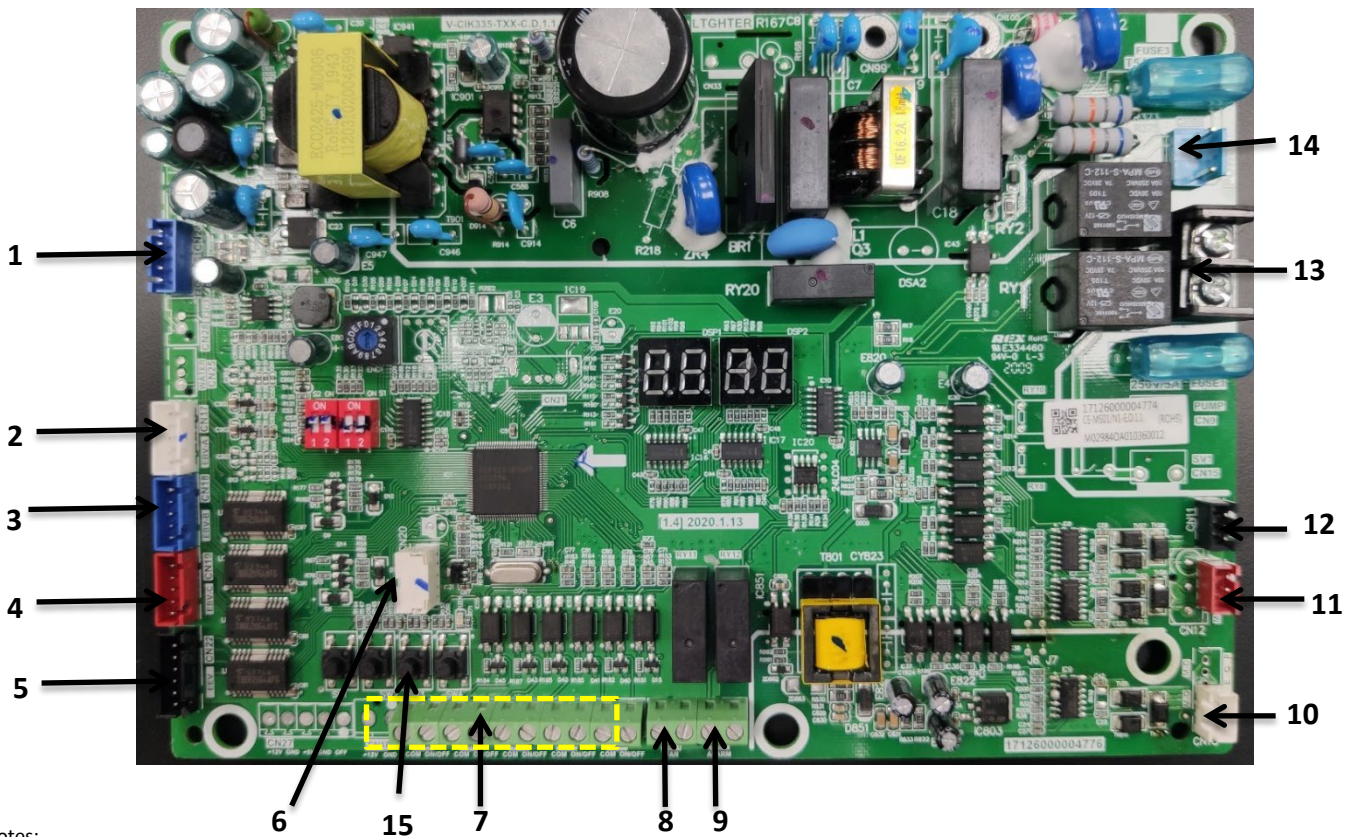

Notes:

1. Label descriptions are given in Table 5-6.1

Table 5-6.1: MS01 main PCB ports

Label in Figure 5-5.1	Code	Content	Port voltage
1	CN24	Temperature sensor(T1C1,T2C2) connection	5VDC
2	CN17	Electric ball valve A connection	12VDC
3	CN18	Electric ball valve B connection	12VDC
4	CN19	Electric ball valve C connection	12VDC
5	CN22	Electric expansion valve A connection	12VDC
6	CN20	Program port	5VDC
7	CN3,CN4,CN5,CN6,CN7	Refrigerant sensors connection	12VDC
8	CN1	Ventilation fan connection	0-1A/0-24VDC/AC
9	CN2	Alarm connection	0-1A/0-24VDC/AC
10	CN10	Communication port to outdoor unit	5VDC
11	CN14	Communication port to indoor unit	5VDC
12	CN11	Communication port to monitor	5VDC
13	CN89	UPS connection	220-240VAC
14	CN88	Power supply connection	220-240VAC
15	SW1,SW2,SW3,SW4	Switches	5VDC

MS04-12

Figure 5-6.1: MS04-12 main PCB ports¹

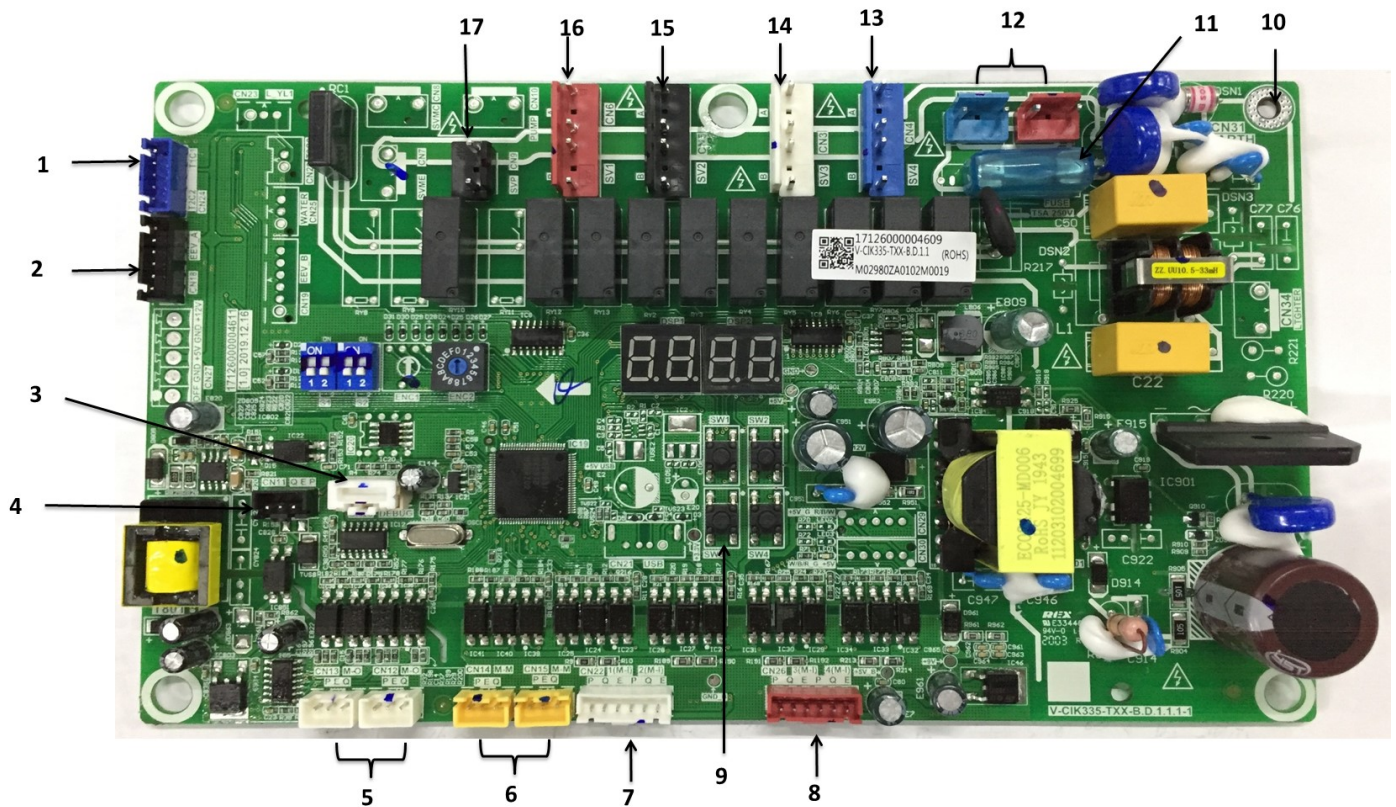

Notes:

1. Label descriptions are given in Table 5-6.2

Table 5-6.2: MS04-12 main PCB ports

Label in Figure 5-5.2	Code	Content	Port voltage
1	CN24	Temperature sensor(T1C1,T2C2) connection	5VDC
2	CN18	Electric expansion valve A connection	12VDC
3	CN20	Program port	5VDC
4	CN11	Communication port to monitor (reserved)	5VDC
5	CN13,CN12	Communication port to outdoor unit or other MS	5VDC
6	CN14,CN15	Communication port to main PCB	5VDC
7	CN22	Communication port to indoor unit	5VDC
8	CN26	Communication port to indoor unit	5VDC
9	SW1,SW2,SW3,SW4	Switches	5VDC
10	CN31	Ground port	/
11	FUSE	T5A/250VAC	220-240VAC
12	CN16、CN17	Power supply port	220-240VAC
13	CN4	Connection to SV4A and SV4B valves	220-240VAC
14	CN3	Connection to SV3A and SV3B valves	220-240VAC
15	CN5	Connection to SV2A and SV2B valves	220-240VAC
16	CN6	Connection to SV1A and SV1B valves	220-240VAC
17	CN9	Connection to SVP valve	220-240VAC

6.2 Spot Check

Press SW1 and SW2 on MS main PCB forward and backward to spot check the MS box data. After 1s shows the no., the display will automatically show the data. For example, to check the outdoor operation mode, press SW1/SW2 to show - -02, then stop and wait for 1s, and the display will show the number of the current outdoor operation mode.

Table 5-6.3: MS01 spot check

DSP content	Parameters displayed on DSP2	Remarks
----	Online IDU quantity & Refrigerant leakage sensor quantity	
--01	Operation IDU quantity	Actual value
--02	System operation mode	0-OFF; 2-Cooling Only; 3-Heating Only; 5-Main Cooling Mode; 6-Main Heating Mode
--03	High pressure (MPa)	Actual value = value displayed × 0.1
--04	Low pressure (MPa)	Actual value = value displayed × 0.01
--05	Subcooler outlet temperature	Actual value = value displayed
--06	Subcooler inlet temperature	Actual value = value displayed
--07	EEV position	Actual value = value displayed × 10
--08	Software version	
--09	MS Address	Actual value = value displayed
--10	EBVA position	Actual value = value displayed × 10
--11	EBVB position	Actual value = value displayed × 10
--12	EBVC position	Actual value = value displayed × 10
--13	Port No. for refrigerant leakage alarm	Actual value = value displayed
--14	Number of ports for refrigerant leakage alarm	Actual value = value displayed
--15	Min (T2, T2B) of cooling operation IDU under the MS	Actual value = value displayed

Table 5-6.4: MS04-12 spot check

DSP content	Parameters displayed on DSP2	Remarks
----	Online IDU quantity	
--01	Operation IDU quantity	Actual value
--02	System operation mode	0-OFF; 2-Cooling Only; 3-Heating Only; 5-Main Cooling Mode; 6-Main Heating Mode
--03	High pressure (MPa)	Actual value = value displayed × 0.1
--04	Low pressure (MPa)	Actual value = value displayed × 0.01
--05	Subcooler outlet temperature	Actual value = value displayed
--06	Subcooler inlet temperature	Actual value = value displayed
--07	EEV position	Actual value = value displayed × 10
--08	Software version	
--09	MS Address	Actual value = value displayed
--10	--	Actual value = value displayed

TVR Ultra HR 50/60Hz



7 Wiring Diagrams

Figure 5-7.1: TVR Ultra HR outdoor unit wiring diagram

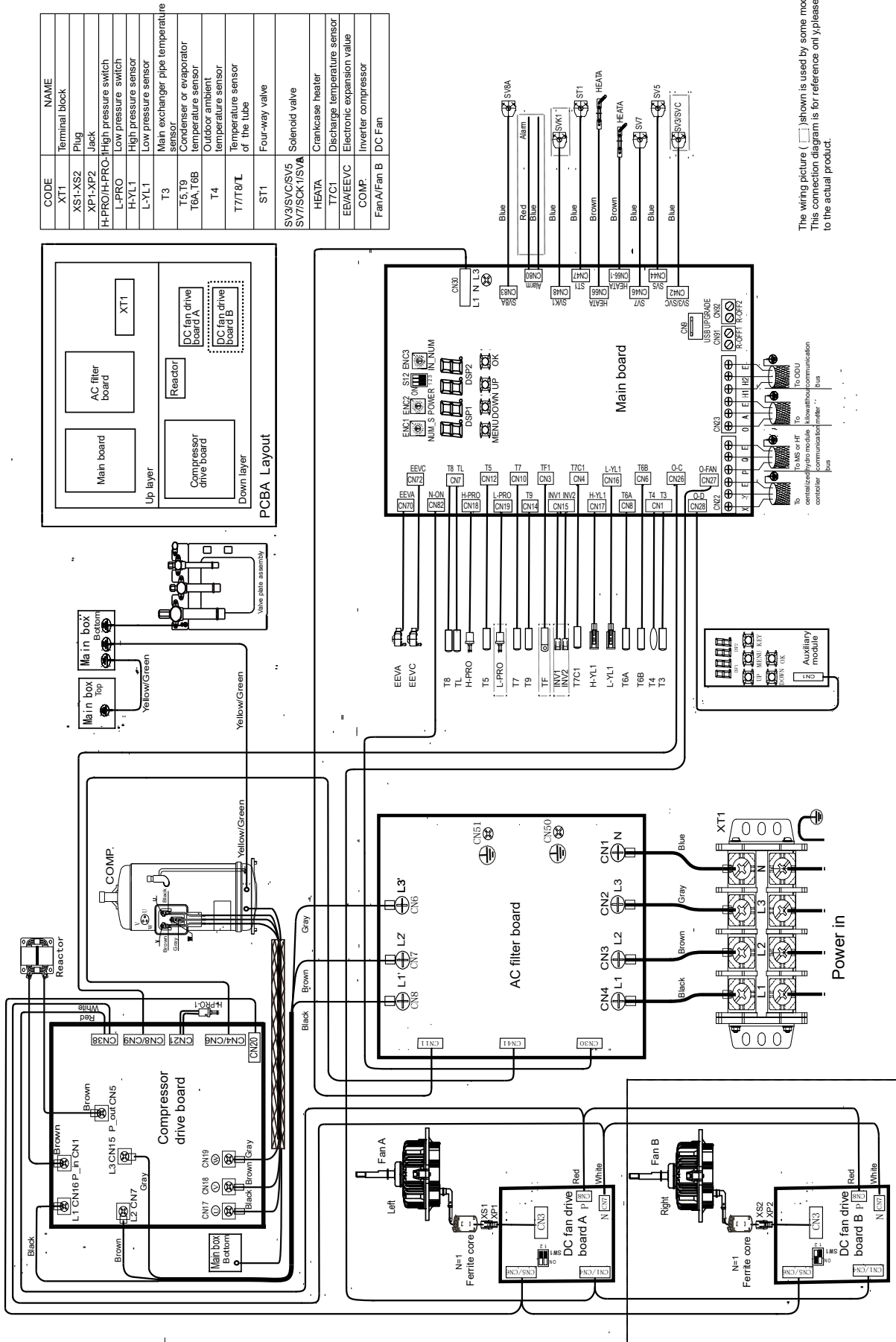
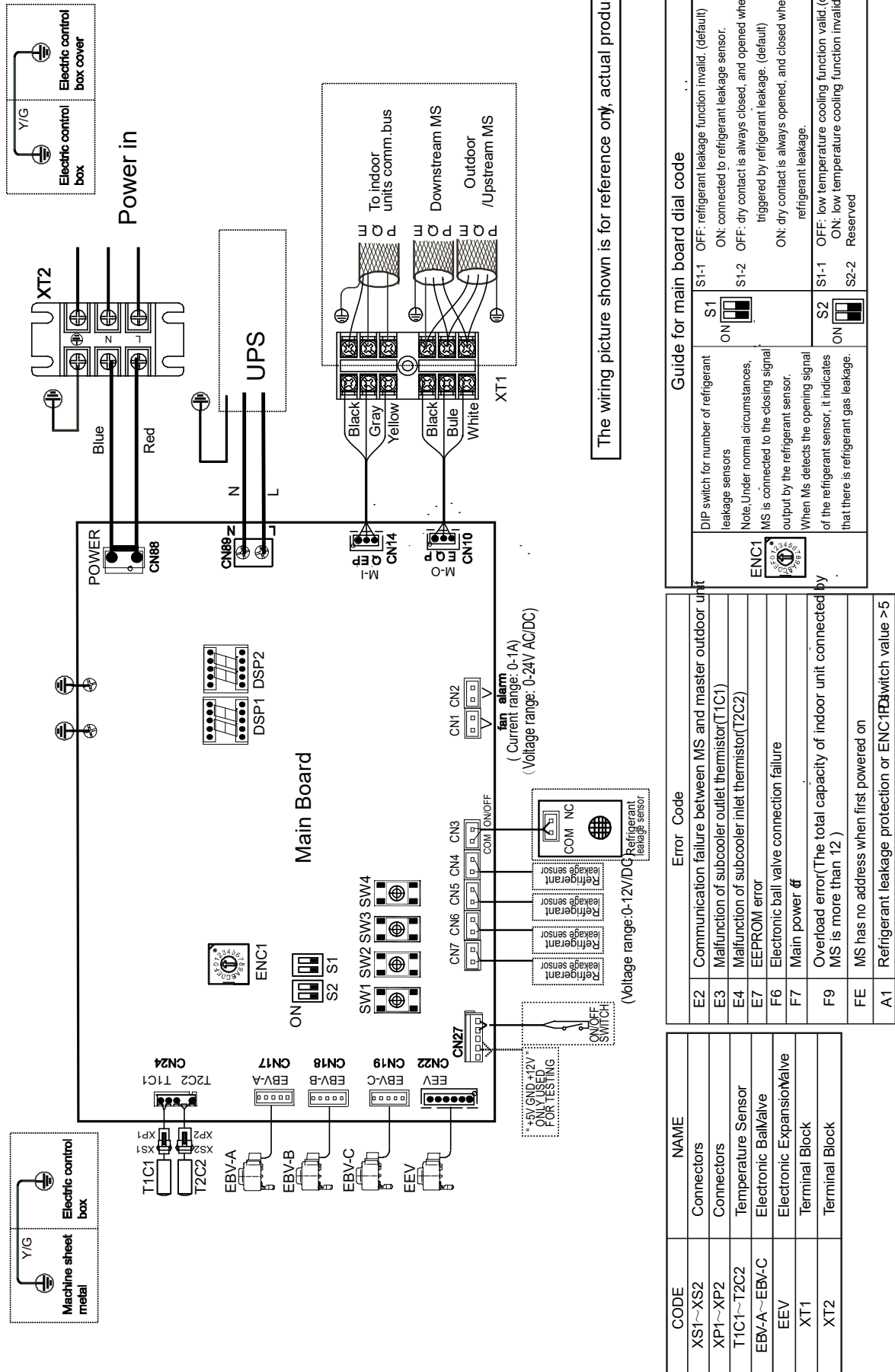

Figure 5-7.2: MS01 wiring diagram



The wiring picture shown is for reference only, actual product may vary.

CODE	NAME	Error Code
XS1~XS2	Connectors	E2 Communication failure between MS and master outdoor unit
XP1~XP2	Connectors	E3 Malfunction of subcooler outlet thermistor(T1C1)
T1C1~T2C2	Temperature Sensor	E4 Malfunction of subcooler inlet thermistor(T2C2)
EBV-A~EBV-C	Electronic BallValve	E7 EEPROM error
EEV	Electronic ExpansionValve	F6 Electronic ball valve connection failure
XT1	Terminal Block	F7 Main power
XT2	Terminal Block	F9 Overload error(The total capacity of indoor unit connected by MS is more than 12)
		FE MS has no address when first powered on
		A1 Refrigerant leakage protection or ENC1IPB switch value >5

Guide for main board dial code	
DIP switch for number of refrigerant leakage sensors	S1-1 OFF: refrigerant leakage function invalid. (default) ON: connected to refrigerant leakage sensor.
Note: Under normal circumstances, MS is connected to the closing signal output by the refrigerant sensor.	S1-2 OFF: dry contact is always closed, and opened when being triggered by refrigerant leakage. (default)
	ON: dry contact is always opened, and closed when being triggered by refrigerant leakage.
When MS detects the opening signal of the refrigerant sensor, it indicates that there is refrigerant gas leakage.	S2-1 OFF: low temperature cooling function valid. (default) ON: low temperature cooling function invalid.
	S2-2 Reserved

TVR Ultra HR 50/60Hz



Figure 5-7.3: MS04/MS06 wiring diagram

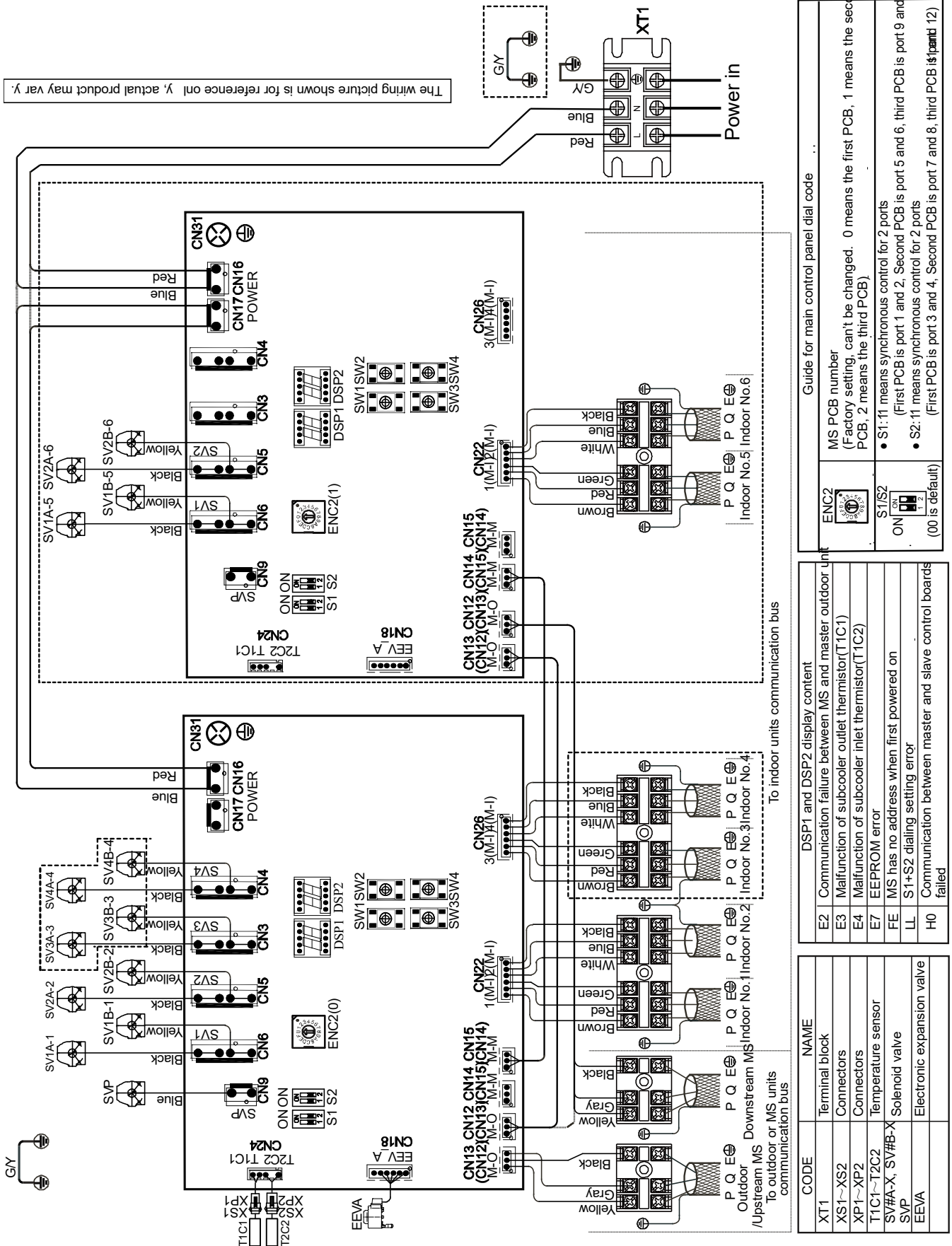

Guide for main control panel dial code	
ENC2	MS PCB number (Factory setting, can't be changed. 0 means the first PCB, 1 means the second PCB, 2 means the third PCB)
S1/S2	<ul style="list-style-type: none"> S1: '1' means synchronous control for 2 ports (First PCB is port 1 and 2, Second PCB is port 5 and 6, third PCB is port 9 and 12) S2: '1' means synchronous control for 2 ports (First PCB is port 3 and 4, Second PCB is port 7 and 8, third PCB is port 11 and 12)
ON	(00 is default)

DSP1 and DSP2 display content	
E2	Communication failure between MS and master outdoor unit
E3	Malfunction of subcooler outlet thermistor(T1C1)
E4	Malfunction of subcooler inlet thermistor(T1C2)
E7	EEPROM error
FE	MS has no address when first powered on
LL	S1+S2 dialing setting error
H0	Communication between master and slave control boards failed

CODE	NAME
XT1	Terminal block
XS1~XS2	Connectors
XP1~XP2	Connectors
T1C1~T2C2	Temperature sensor
SV#A-X, SV#B-X	Solenoid valve
SVP	Solenoid expansion valve
EEVA	Electronic expansion valve

Part 6

Diagnosis and Troubleshooting

1 Error Code Table.....	84
2 Troubleshooting for Outdoor Unit.....	87
3 Troubleshooting for Mode Selection Box.....	151
4 Appendix to Part 6	163

1 Error Code Table

Table 6-1.1: Outdoor Error code table

Error code ¹	Content	Remarks	Manual re-start required ²
E0	Communication error between outdoor units	Only displayed on the slave unit with the error	No
E2	Communication error between MS and master unit	Only displayed on the master unit with the error	No
E4	T3/T4 temperature sensor error		No
E5	Abnormal power supply voltage		No
E7	Discharge temperature sensor error (T7C1)		No
E8	Outdoor unit address error		Yes
E9	EEPROM mismatch of compressor		Yes
F1	DC bus voltage error		No
F3	T6B temperature sensor error		No
F5	T6A temperature sensor error		No
zF6	Electronic expansion valve connection error	Refer to Note 3	Yes
F9	T5 temperature sensor error		No
FA	T8 temperature sensor error		No
Fb	T9 temperature sensor error		No
Fc	TL temperature sensor error		No
Fd	T7 temperature sensor error		No
H0	Communication error between main board and compressor drive board		No
H2	Qty. of outdoor unit decreases error	Only displayed on the master unit with the error	No
H3	Qty. of outdoor unit increases error	Only displayed on the master unit with the error	No
H4	Compressor inverter module protection		Yes
H5	Low pressure protection lock out (P2 3X in 60 minutes)		Yes
H6	Compressor discharge temperature protection (P4 3X in 100 minutes)		Yes
H7	Qty. of indoor units mismatching		No
H8	High pressure sensor error		No
H9	DC fan module protection (P9 10X in 120 minutes)		Yes
Hb	Low pressure sensor error		No
yHd	Slave unit malfunction(y=1,2 ,1Hd stands for slave unit 1 error)	Only displayed on the master unit with the error	No
C7	Compressor inverter module temperature protection (PL 3X in 100 minutes)		Yes
P1	High pressure protection		No
P2	Low pressure protection		No
P31	Primary current protection		No
P32	Secondary current protection		No
P4	Discharge temperature protection or discharge temperature switch protection		No
xP9	DC fan module protection		No
PL	Compressor inverter module temperature protection		No
PP	Compressor discharge insufficient superheat protection		No

Table continued on next page ...

Table 6-1.1: Error code table (continued)

Error code ¹	Content	Remarks	Manual re-start required ²
A0	Emergency shutdown		No
A1w	Refrigerant leakage protection		Yes
CA1	There are other indoor unit connected except the 2 nd generation DC IDU	Only displayed on the master unit with the error	Yes
CA2	The system is connected to AHU kit only.	Only displayed on the master unit with the error	Yes
CA3	The system is connected only to the high temperature hydro module (HT hydro module)	Only displayed on the master unit with the error	Yes
CA4	The system is simultaneously connected to AHU kit + HT hydro module	Only displayed on the master unit with the error	Yes
CA5	The system is simultaneously connected to TVR Indoor + AHU kit + HT hydro module.	Only displayed on the master unit with the error	Yes
Cb1	TVR Indoor is beyond the permitted connection range	Only displayed on the master unit with the error	Yes
Cb2	AHU KIT is beyond the permitted connection range	Only displayed on the master unit with the error	Yes
Cb3	The HT hydro module is beyond the permitted connection range	Only displayed on the master unit with the error	Yes
Cb4	The number of IDUs connected to the system is beyond the permitted connection range	Only displayed on the master unit with the error	Yes
L0	Inverter compressor module error	Displayed on the unit with the error	No
L1	DC bus low voltage protection	Displayed on the unit with the error	No
L2	DC bus high voltage protection	Displayed on the unit with the error	No
L3	Reserved	Displayed on the unit with the error	No
L4	MCE error	Displayed on the unit with the error	No
L5	Zero speed protection	Displayed on the unit with the error	No
L6	Motor parameter error	Displayed on the unit with the error	No
L7	Phase sequence error	Displayed on the unit with the error	No
L8	Compressor frequency hopping error	Displayed on the unit with the error	No
LA	PED software verification failed	Displayed on the unit with the error	No
U0	In the event of S10=ON, a forced test operation is set. However, a test operation is not performed for 30 minutes after power-on.	Only displayed on the master unit with the error	No
U21/U22/U23	Ambient temperature is not suitable for test operation	Only displayed on the master unit with the error	No
U31/U32/U33	Stop valve is not open	Only displayed on the master unit with the error	No
U4	Indoor unit refrigerant pipe and signal cable connection are inconsistent.	Only displayed on the master unit with the error	No

Notes:

- 'x' is a placeholder for the Fan address, with 1 representing Fan A and 2 representing Fan B. 'y' is a placeholder for the address (1or2) of the slave unit with the error. 'z' is a number for the electronic expansion valve, with 1 representing electronic expansion valve A and 2 representing electronic expansion valve C. 'w' is a placeholder for the protection mode of refrigerant leakage, with 1 representing the system should force to shutdown after the protection, 2 representing the system should force to shutdown after the protection in 12 hours and 3 representing the system should force to shutdown after the protection in 24 hours.
- For some error codes, a manual restart is required before the system can resume operation.
- Once the EEV has been connected properly, the error code will flash to indicate that the connection has been re-established. A manual restart is then required before the system can resume operation.

Table 6-1.2: MS04-12 Error code table

Error code	Content	Remarks	Manual re-start required ¹
E2	Communication failure between MS and master outdoor unit	The indoor unit display board or wired controller connected under this MS displays "F8" fault code	No
E3	Malfunction of subcooler outlet thermistor(T1C1)	The indoor unit display board or wired controller connected under this MS displays "F8" fault code	No
E4	Malfunction of subcooler inlet thermistor(T2C2)	The indoor unit display board or wired controller connected under this MS displays "F8" fault code	No
E7	EEPROM error	The indoor unit display board or wired controller connected under this MS displays "F8" fault code	Yes
FE	MS has no address when first powered on	The indoor unit display board or wired controller connected under this MS displays "F8" fault code	No
LL	S1+S2 dialing setting error	The indoor unit display board or wired controller connected under this MS displays "F8" fault code	Yes
H0	Communication between master and slave control boards failed	The indoor unit display board or wired controller connected under this MS displays "F8" fault code	No

Notes:

1. For some error codes, a manual restart is required before the system can resume operation.

Table 6-1.3: MS01 Error code table

Error code	Content	Remarks	Manual re-start required ¹
E2	Communication failure between MS and master outdoor unit	The indoor unit display board or wired controller connected under this MS displays "F8" fault code	No
E3	Malfunction of subcooler outlet thermistor(T1C1)	The indoor unit display board or wired controller connected under this MS displays "F8" fault code	No
E4	Malfunction of subcooler inlet thermistor(T2C2)	The indoor unit display board or wired controller connected under this MS displays "F8" fault code	No
E7	EEPROM error	The indoor unit display board or wired controller connected under this MS displays "F8" fault code	Yes
FE	MS has no address when first powered on	The indoor unit display board or wired controller connected under this MS displays "F8" fault code	No
F6	Electronic ball valve connection failure	The indoor unit display board or wired controller connected under this MS displays "F8" fault code	Yes
F7	Main power off	The indoor unit display board or wired controller connected under this MS displays "F8" fault code	No
F9	Overload error	The indoor unit display board or wired controller connected under this MS displays "F8" fault code	Yes
A1	Refrigerant leakage protection	All outdoor units, indoor units and controllers display "A1"	Yes

Notes:

1. For some error codes, a manual restart is required before the system can resume operation.

2 Troubleshooting for Outdoor Unit

2.1 Warning

Warning



- All electrical work must be carried out by competent and suitably qualified, certified and accredited professionals and in accordance with all applicable legislation (all national, local and other laws, standards, codes, rules, regulations and other legislation that apply in a given situation).
- Power-off the outdoor units before connecting or disconnecting any connections or wiring, otherwise electric shock (which can cause physical injury or death) may occur or damage to components may occur.

2.2 E0: Communication error between outdoor units

2.2.1 Digital display output



2.2.2 Description

- Communication error between outdoor units.
- All units stop running.
- Error code is only displayed on the slave unit with the error.

2.2.3 Trigger / recover condition

- Trigger condition: Slave unit cannot receive signal from master unit for 60s.
- Recover condition: Slave unit can receive signal from master unit.
- Reset method: Resume automatically.

2.2.4 Possible causes

- Incorrect outdoor unit address setting.
- Communication wires between outdoor units not connected properly.
- Loosened wiring within electric control box.
- Damaged outdoor main PCB or electric control box communication terminals block.

2.2.5 Procedure

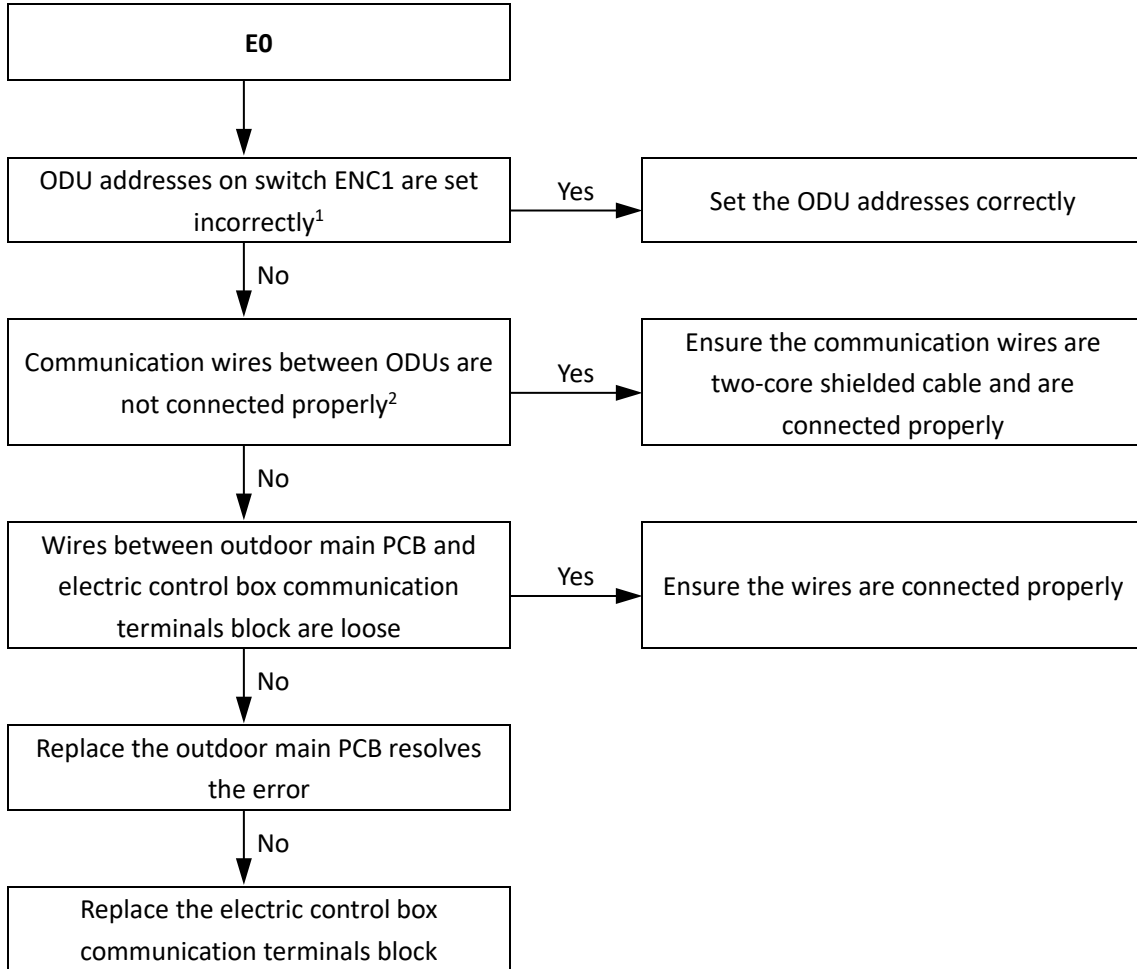

Notes:

1. The master unit address should be set as 0, slave units' addresses should be set from 1 to 2, and the addresses should not be repeated within one system.
2. All the wires for H1, H2, E connections should be three-core shielded cable, the wiring should be connected according to polarity (H1 to H1, H2 to H2), and the wiring should not be open or short circuited.

2.3 E2: Communication error between MS box and master unit

2.3.1 Digital display output

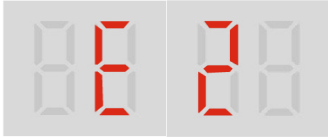

2.3.2 Description

- Communication error between MS box and master outdoor unit.
- All units stop running.
- Error code is only displayed on the master unit.

2.3.3 Trigger / recover condition

- Trigger condition: MS box and outdoor units cannot communication for 2 minutes after the system power on 20 minutes.
- Recover condition: Communication go back to normal.
- Reset method: Resume automatically.

2.3.4 Possible causes

- Communication wires between MS box and outdoor units not connected properly.
- MS box power supply abnormal.
- Loosened wiring within electric control box.
- The sequence of the PQE signal lines is incorrect.
- Interference from high voltage wires or other sources of electromagnetic radiation.
- Communication wire too long.
- Damaged outdoor main PCB or electric control box communication terminals block.

2.3.5 Procedure

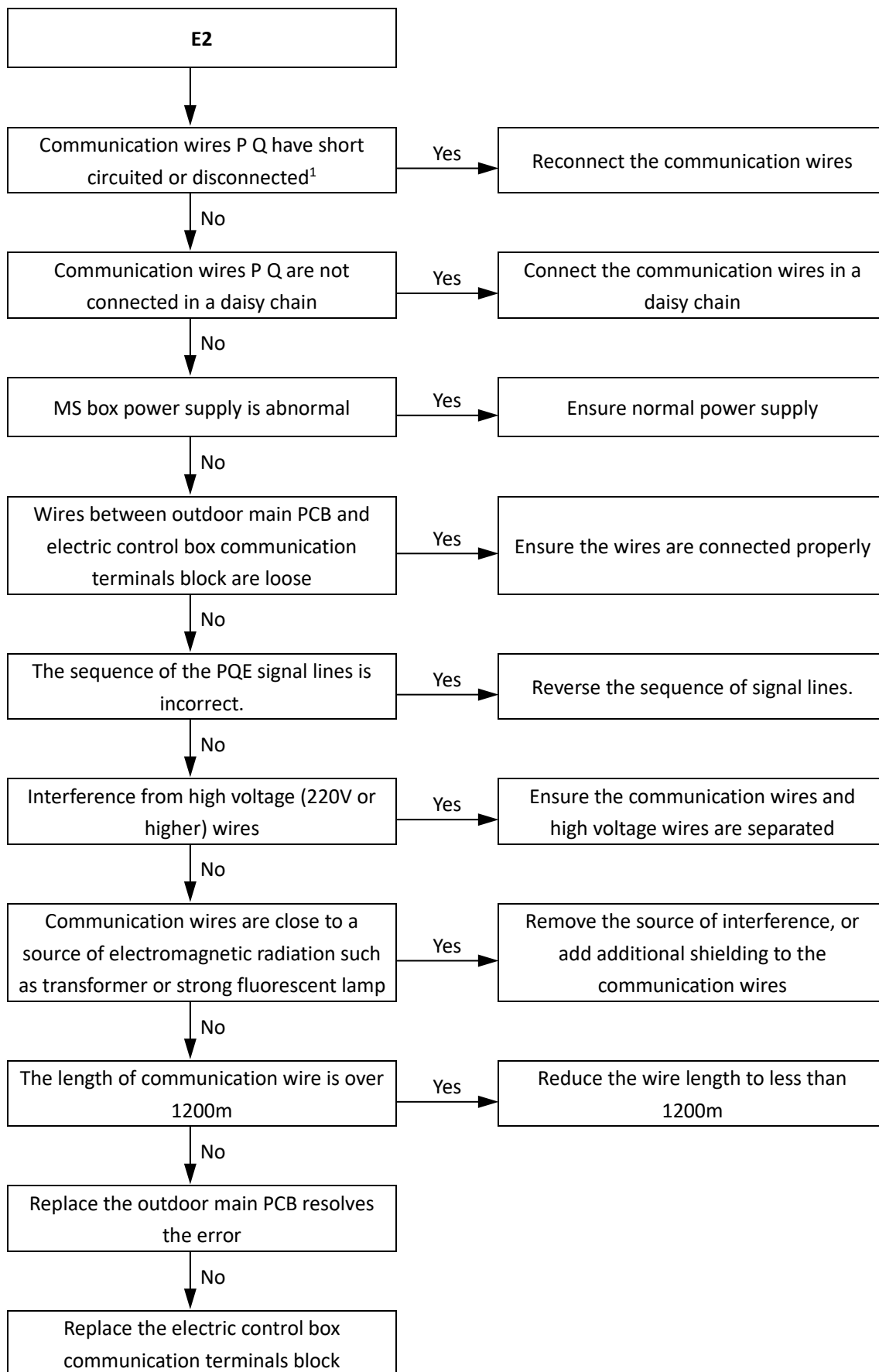

Notes:

1. Measure the resistance among P, Q and E. The normal resistance between P and Q is 120Ω, between P and E is infinite, between Q and E is infinite.

2.4 E4: T3/T4 Temperature sensor error

2.4.1 Digital display output



2.4.2 Description

- Heat exchanger deicer temperature sensor (T3) error or outdoor air temperature sensor (T4) error.
- All units stop running.
- Error code is displayed on the unit with the error.

2.4.3 Trigger / recover condition

- Trigger condition: The main control board cannot receive the feedback signal of temperature sensor T3 or T4.
- Recover condition: The main control board can receive the feedback signal of temperature sensor T3 or T4.
- Reset method: Resume automatically.

2.4.4 Possible causes

- Temperature sensor not connected properly or has malfunction.
- Outdoor main PCB damaged.

2.4.5 Procedure

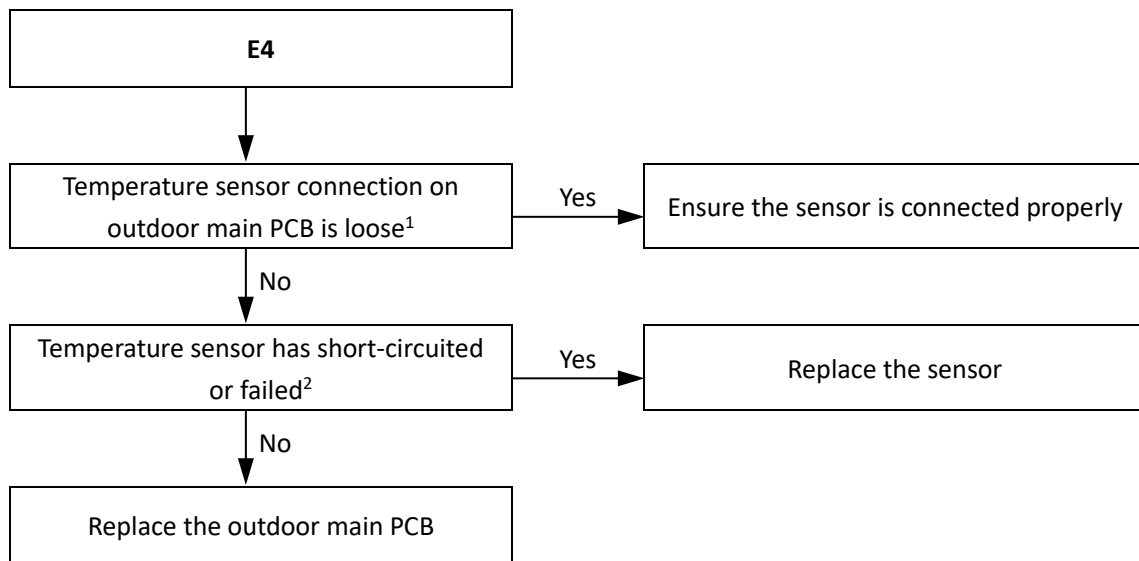

Notes:

1. Outdoor air temperature sensor (T4) and heat exchanger deicer temperature sensor (T3) connection is port CN1 on the outdoor main PCB.
2. Measure sensor resistance. If the resistance is too low, the sensor has short-circuited. If the resistance is not consistent with the sensor's resistance characteristics table, the sensor has failed. Refer to Table 6-4.1 in Part 6, 4.1 "Temperature Sensor Resistance Characteristics".

2.5 E5: Abnormal power supply voltage

2.5.1 Digital display output



2.5.2 Description

- Abnormal power supply voltage.
- All units stop running.
- Error code is displayed on the unit with the error.

2.5.3 Trigger / recover condition

- Trigger condition: Outdoor unit power supply phase voltage $< 170\text{V}$ or $\geq 270\text{V}$.
- Recover condition: Outdoor unit power supply phase voltage is $\geq 180\text{V}$ and $< 260\text{V}$.
- Reset method: Resume automatically.

2.5.4 Possible causes

- Outdoor unit power supply voltage is abnormal or a phase is missing.
- Loosened wiring within electric control box.
- High voltage circuit error.
- Outdoor main PCB damaged.

2.5.5 Procedure

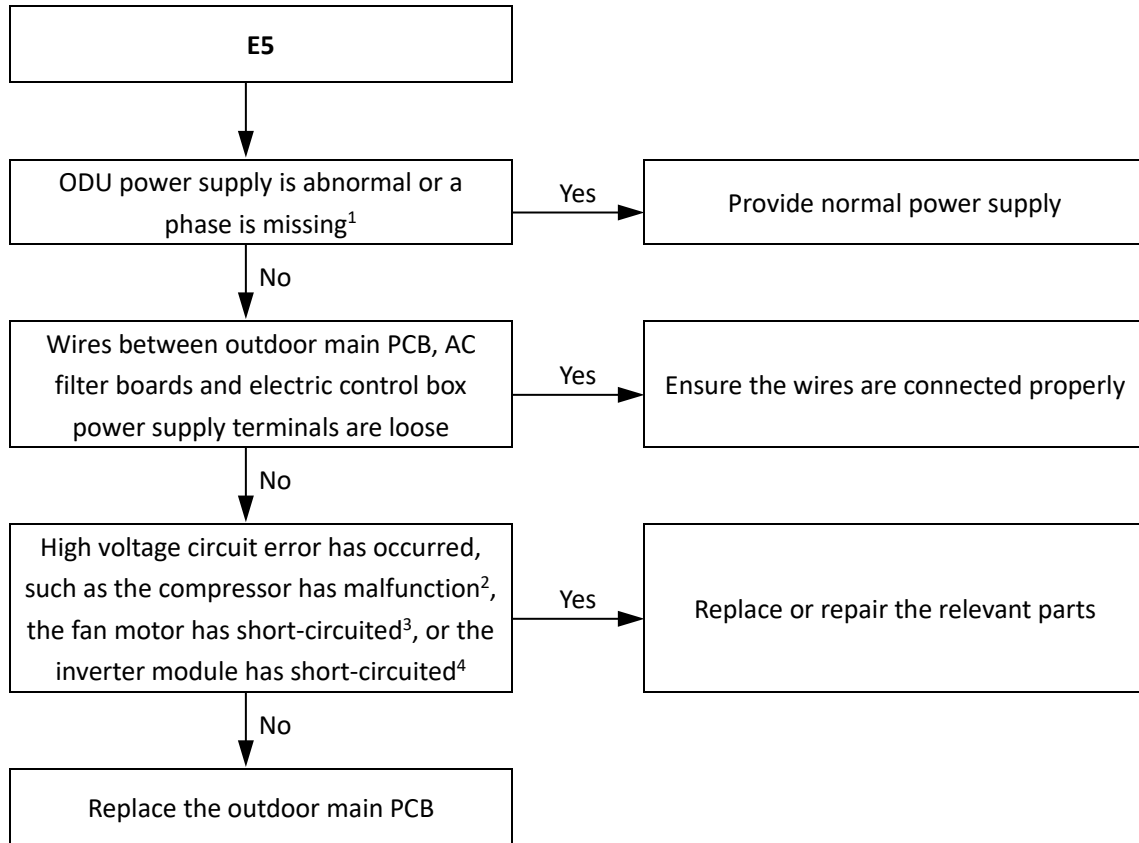

Notes:

1. The normal voltage between A and N, B and N, and C and N is 198-242V.
2. The normal resistances of the inverter compressor are 0.05-0.15Ω among U V W and infinite between each of U V W and ground. If any of the resistances differ from these specifications, the compressor has malfunction.
3. The normal resistances of the fan motor coil among U V W are less than 10Ω. If a measured resistance is 0Ω, the fan motor has short-circuited.
4. Set a multi-meter to buzzer mode and test any two terminals of P N U V W of the inverter module. If the buzzer sounds, the inverter module has short-circuited.

Figure 6-2.1: Inverter module terminals



2.6 E7: Discharge Temperature sensor error (T7C1)

2.6.1 Digital display output



2.6.2 Description

- A compressor top temperature sensor or discharge pipe temperature sensor (T7C1) error.
- All units stop running.
- Error code is displayed on the unit with the error.

2.6.3 Trigger / recover condition

- Trigger condition: Discharge pressure $\geq 3.0\text{MPa}$ and discharge temperature $< 15^\circ\text{C}$ for 2 minutes when the compressor is running.
- Recover condition: Discharge pressure and temperature go back to normal.
- Reset method: Manually restart.

2.6.4 Possible causes

- Temperature sensor not connected properly or has malfunction.
- Outdoor main PCB damaged.

2.6.5 Procedure

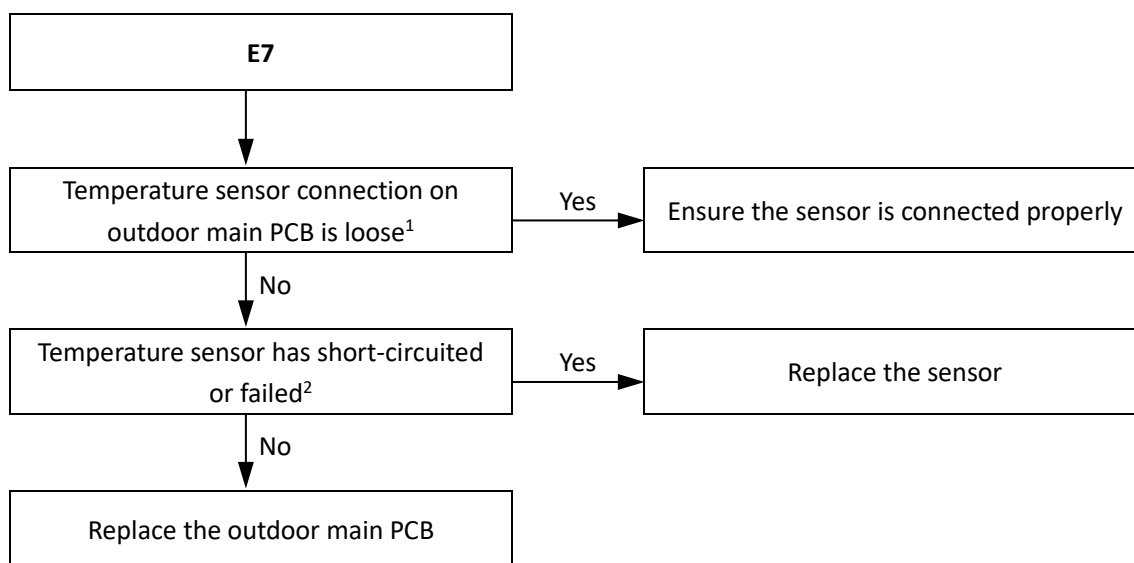

Notes:

1. Compressor discharge pipe temperature sensor connections are ports CN4 on the outdoor main PCB
2. Measure sensor resistance. If the resistance is too low, the sensor has short-circuited. If the resistance is not consistent with the sensor's resistance characteristics table, the sensor has failed. Refer to Table 6-4.2 in Part 6, 4.1 "Temperature Sensor Resistance Characteristics".

2.7 E8: Outdoor unit address error

2.7.1 Digital display output



2.7.2 Description

- Outdoor unit address error.
- All units stop running.
- Error code is displayed on the unit with the error.

2.7.3 Trigger / recover condition

- Trigger condition: Outdoor unit address is set more than 2.
- Recover condition: Outdoor unit addresses are set from 0 to 2.
- Reset method: Manually restart.

2.7.4 Possible causes

- Invalid outdoor unit address.
- Outdoor main PCB damaged.

2.7.5 Procedure

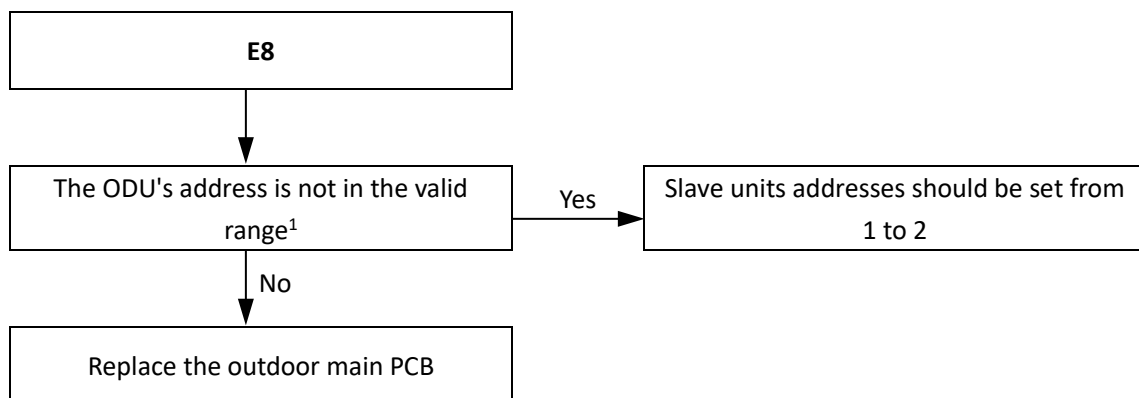

Notes:

1. The master unit address should be set as 0, slave units' addresses should be set from 1 to 2, and the addresses should not be repeated within one system.

2.8 E9: EEPROM mismatch of compressor

2.8.1 Digital display output

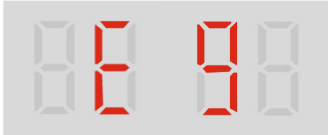

2.8.2 Description

- EEPROM mismatch of compressor.
- All units stop running.
- Error code is displayed on the unit with the error.

2.8.3 Trigger / recover condition

- Trigger condition: Compressor drive parameter is mismatch.
- Recover condition: Compressor drive parameter is match.
- Reset method: Manually restart.

2.8.4 Possible causes

- Outdoor unit was powered on immediately after being powered off.
- Outdoor main PCB damaged.

2.8.5 Procedure

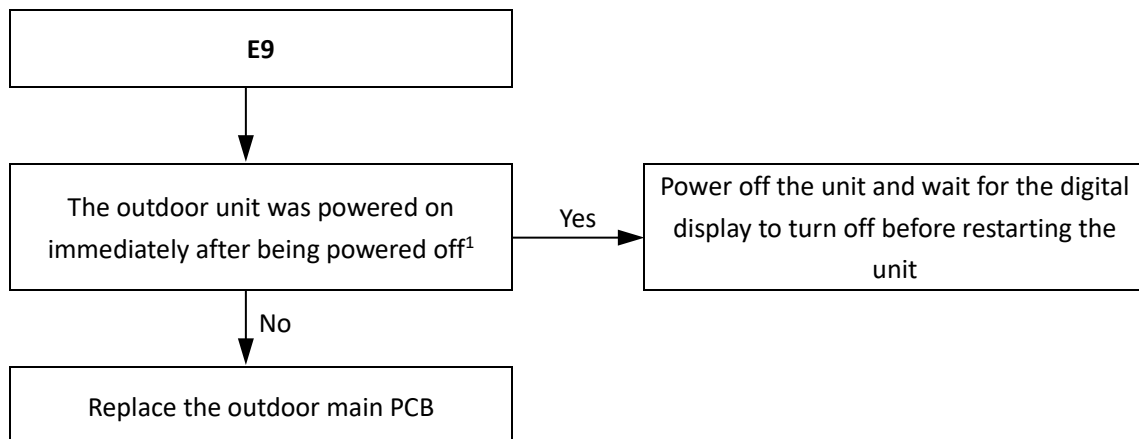

Notes:

1. When performing a manual restart of an outdoor unit, once the unit has been powered off it should not be powered on again until the digital display has turned off.

2.9 F1: DC bus voltage error

2.9.1 Digital display output



2.9.2 Description

- All units stop running.
- Error code is displayed on the unit with the error.

2.9.3 Trigger / recover condition

- Trigger condition: DC bus voltage < 300V or DC bus voltage >800V continuously for 10 seconds.
- Recover condition: DC bus voltage goes back to normal.
- Reset method: Restart automatically.

2.9.4 Possible causes

- Loosened wiring of the compressor inverter module.
- Incorrect wiring of the reactor and DC bus wire.
- Abnormal power supply.
- Inverter module damaged.

2.9.5 Procedure

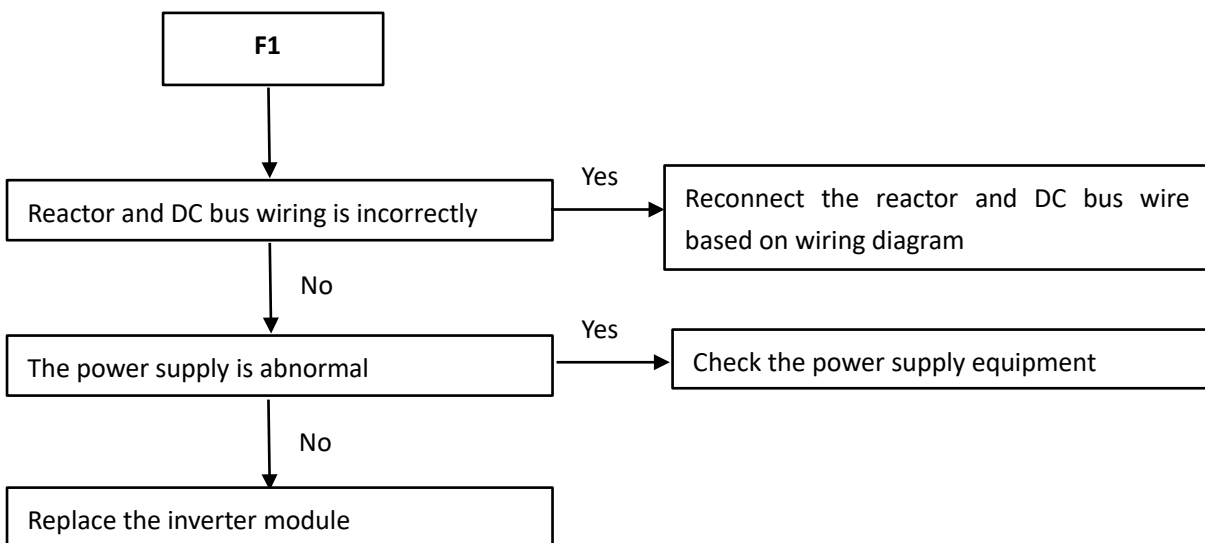

2.10 F3, F5, F9, FA, Fb, Fc, Fd: T6B/T6A/T5/T8/T9/TL/T7 Temperature sensor error

2.10.1 Digital display output

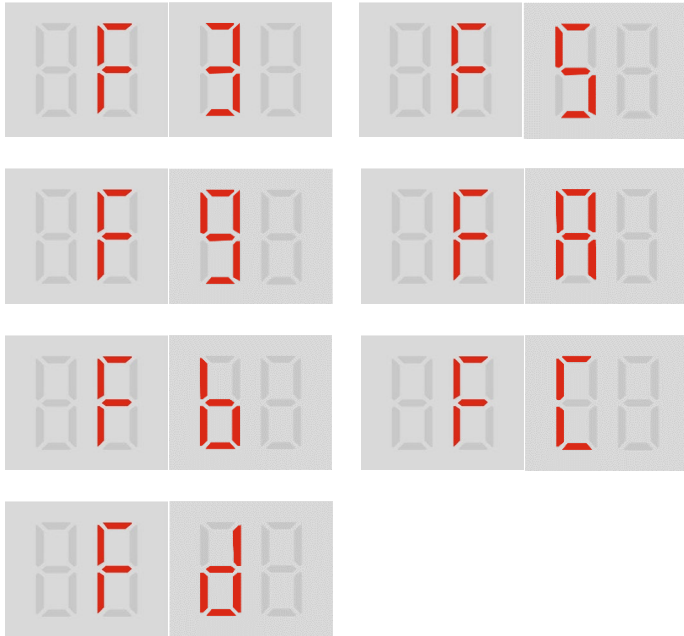

2.10.2 Description

- F3 indicates subcooling gas temperature sensor (T6B) error.
- F5 indicates injection liquid temperature sensor (T6A) error.
- F9 indicates liquid pipe temperature sensor (T5) error.
- FA indicates heat exchanger gas temperature sensor (T8) error.
- Fb indicates heat sink temperature sensor (T9) error.
- Fc indicates heat exchanger liquid temperature sensor (TL) error.
- Fd indicates suction temperature sensor (T7) error.
- All units stop running.
- Error code is displayed on the unit with the error.

2.10.3 Trigger / recover condition

- Trigger condition: Temperature sensor T6A/T6B/T5/T7/T8/T9/TL is open or short-circuited.
- Recover condition: Temperature sensor T6A/T6B/T5/T7/T8/T9/TL connection ports can detect load.
- Reset method: Resume automatically.

2.10.4 Possible causes

- Temperature sensor not connected properly or has malfunction.
- Damaged outdoor main PCB.

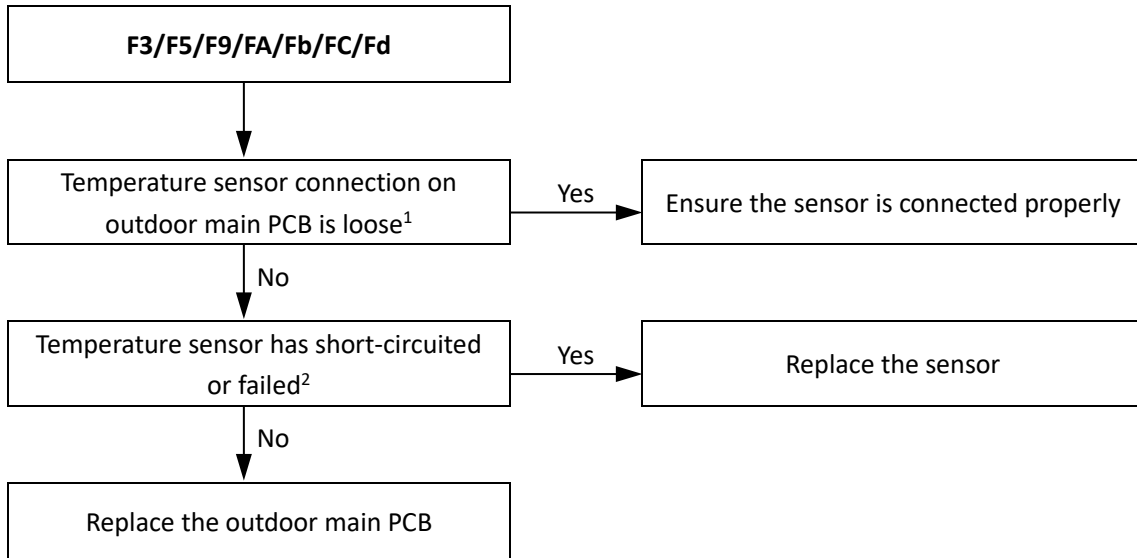
2.10.5 Procedure

Notes:

1. Injection liquid temperature sensor (T6A) and subcooling gas temperature sensor (T6B) connection are port CN8 and CN6 on the outdoor main PCB. Liquid pipe temperature sensor (T5) and Heat sink Temperature sensor (T9) error connection are port CN12 and CN14 on the outdoor main PCB. Heat exchanger gas Temperature sensor (T8) and Heat exchanger liquid Temperature sensor (TL) connection are port CN7 on the outdoor main PCB. Suction Temperature sensor (T7) connection is port CN10 on the outdoor main PCB.
2. Measure sensor resistance. If the resistance is too low, the sensor has short-circuited. If the resistance is not consistent with the sensor's resistance characteristics table, the sensor has failed. Refer to Table 6-4.1 in Part 6, 4.1 "Temperature Sensor Resistance Characteristics".

2.11 zF6: Electronic expansion valve connection error

2.11.1 Digital display output



2.11.2 Description

- 1F6 indicates Electronic expansion valve A connection error.
- 2F6 indicates Electronic expansion valve C connection error.
- All units stop running.
- Error code is displayed on the unit with the error.

2.11.3 Trigger / recover condition

- Trigger condition: The main control board cannot receive the feedback signal of EEV.
- Recover condition: The main control board can receive the feedback signal of EEV.
- Reset method: When the main control board can receive the feedback signal of EEV, F6 flashes, a manual system restart is required before the system can resume operation.

2.11.4 Possible causes

- Electronic expansion valve coil not connected properly or has malfunction.
- Outdoor main PCB damaged.

2.11.5 Procedure

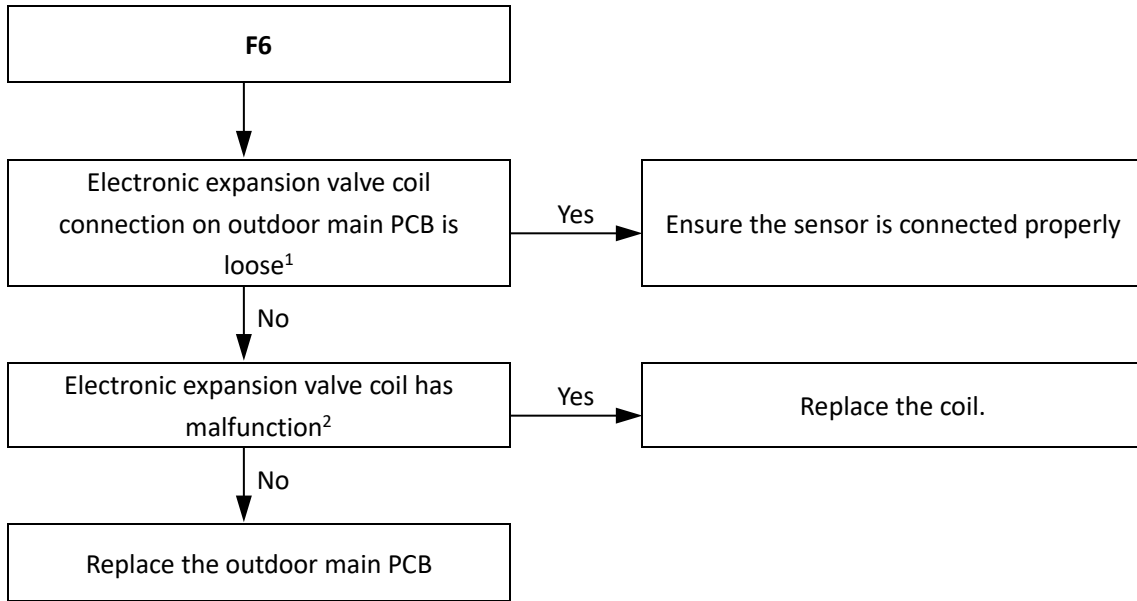

- Notes:
1. Electronic expansion valve coil connections are port CN70 and CN72 on the outdoor main PCB
 2. The normal resistances between EEV coil wiring terminals RED and white / yellow / orange / blue are 40-50Ω. If any of the resistances differ from the value, the EEV coil has malfunction.

Figure 6-2.3: EEV coil wiring terminals

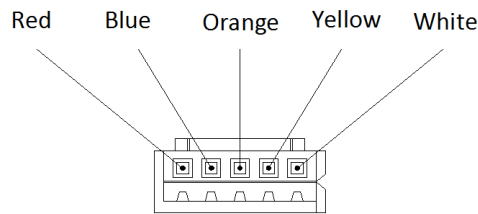

2.12 H0: Communication error between main board and compressor drive board

2.12.1 Digital display output

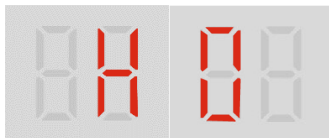

2.12.2 Description

- H0 indicates a communication error between main board and compressor drive board.
- All units stop running.
- Error code is displayed on the unit with the error.

2.12.3 Trigger / recover condition

- Trigger condition: Main control board and inverter driver board cannot communication for 2 minutes.
- Recover condition: Communication go back to normal.
- Reset method: Resume automatically.

2.12.4 Possible causes

- Loosened communication wiring from the outdoor main PCB to the inverter module.
- Filter board damaged.
- Compressor inverter module damaged.
- Outdoor main PCB damaged.

2.12.5 Procedure

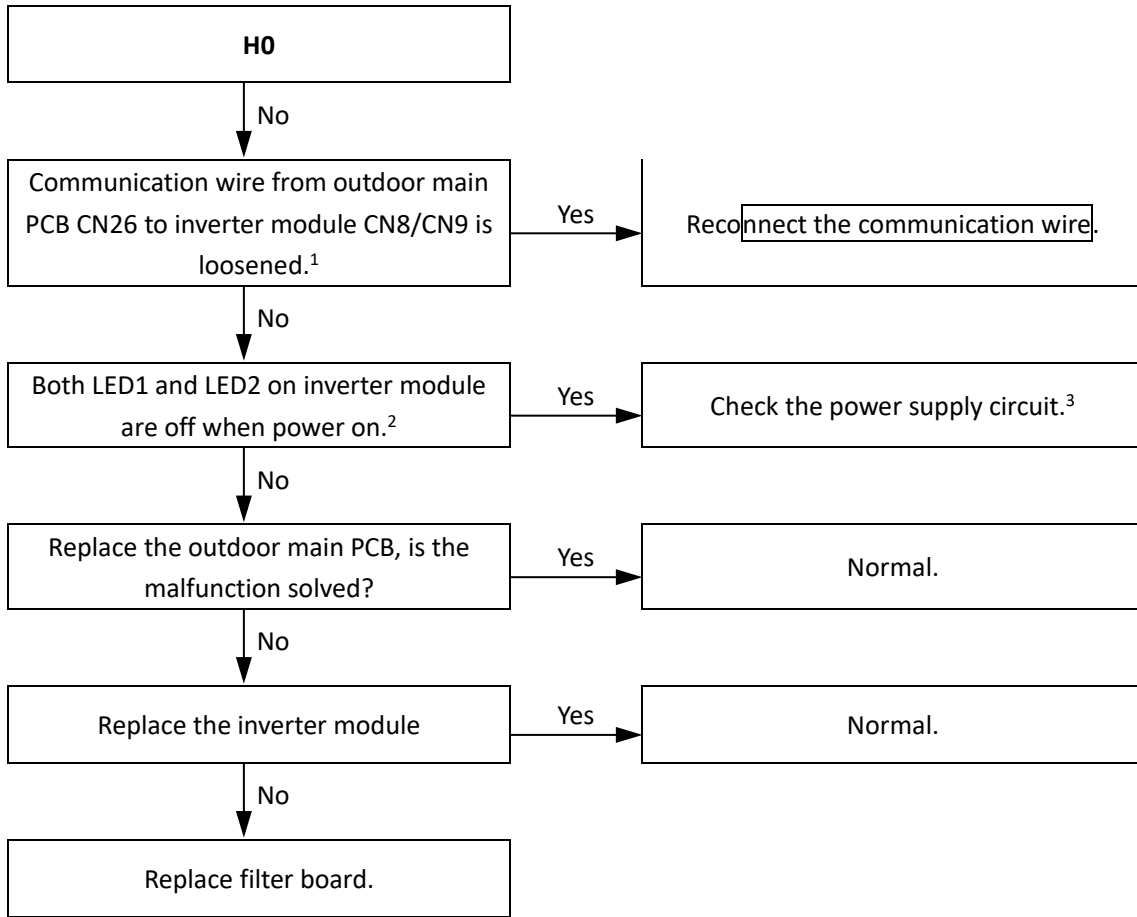

Notes:

1. Communication wire from outdoor main PCB CN26 to inverter module CN8/CN9.

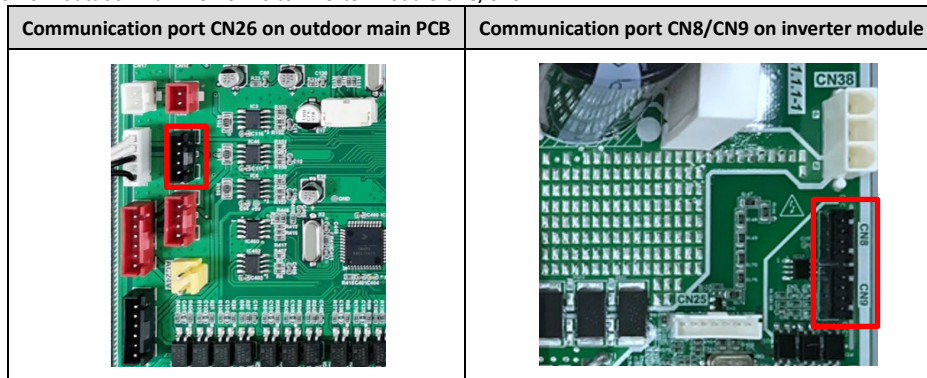

2. LED1/2 on inverter module

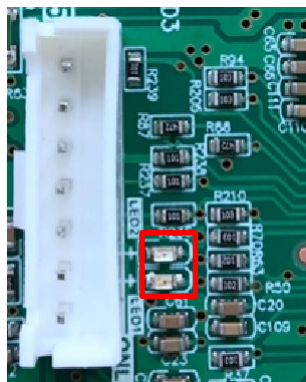

3. Check the power supply for the compressor inverter module, the normal voltage L2 and N (CN4/CN6) 198v-242V.

2.13 H2, H3: Qty. of outdoor unit decreases/ increases error

2.13.1 Digital display output

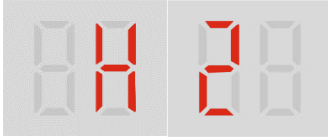

2.13.2 Description

- H2 indicates Qty. of outdoor unit decreases error.
- H3 indicates Qty. of outdoor unit increases error.
- All units stop running.
- Error code is only displayed on the master unit.

2.13.3 Trigger / recover condition

- Trigger condition: Qty. of slave units detected by master unit has decreased or increased.
- Recover condition: Qty. of slave units detected by master unit goes back to normal.
- Reset method: Resume automatically.

2.13.4 Possible causes

- Some outdoor units are powered off.
- Power supply abnormal.
- Incorrect outdoor unit address setting.
- Communication wires between outdoor units not connected properly.
- Loosened wiring within electric control box.
- Damaged outdoor main PCB or electric control box communication terminals block.

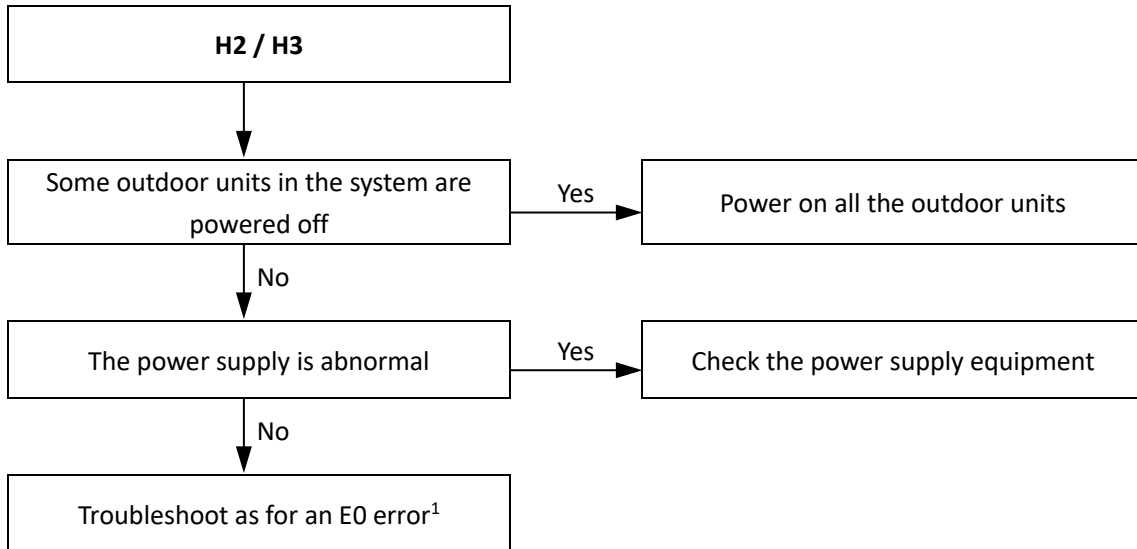
2.13.5 Procedure**Notes:**

1. Refer to "E0 Troubleshooting".

2.14 H4: Compressor inverter module protection

2.14.1 Digital display output

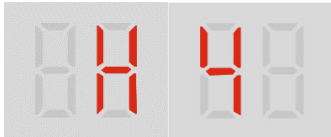

2.14.2 Description

- All units stop running.
- Error code is displayed on the unit with the error.

2.14.3 Trigger / recover condition

- Trigger condition: Compressor appears three inverter module protections.
- Recover condition: Inverter module goes back to normal.
- Reset method: Manually restart.

2.14.4 Possible causes

- Inverter module protection.
- DC bus low or high voltage protection.
- Zero speed protection.
- Phase sequence error.
- Excessive compressor frequency variation.
- PED software verification failed.

2.14.5 Specific error codes for H4 inverter module protection

If an H4 error code is displayed, enter menu mode “n31” (refer to Part 5, 2.2.3 “menu mode”) to check the history error code. Specific error code: L0, L1, L2, L5, L7, LA. can be obtained. If 3 times of L0 to LA protection occurs within 1 hour, H4 protection will appear on the digital tube of main board or spot check board.

Table 6-2.1: Specific error codes for error H4

Specific error code ¹	Content
L0	Inverter compressor module error
L1	DC bus low voltage protection
L2	DC bus high voltage protection
L5	Zero speed protection
L7	Phase sequence error
LA	PED software verification failed

The specific error codes L0, L1, L2, L5, L7 and LA can also be obtained from the inverter module LED indicators. If an inverter module error has occurred, LED2(green) is continuously on and LED1(red) flashes.

Figure 6-2.4: 8-12HP LED indicators LED1 and LED2 on inverter module

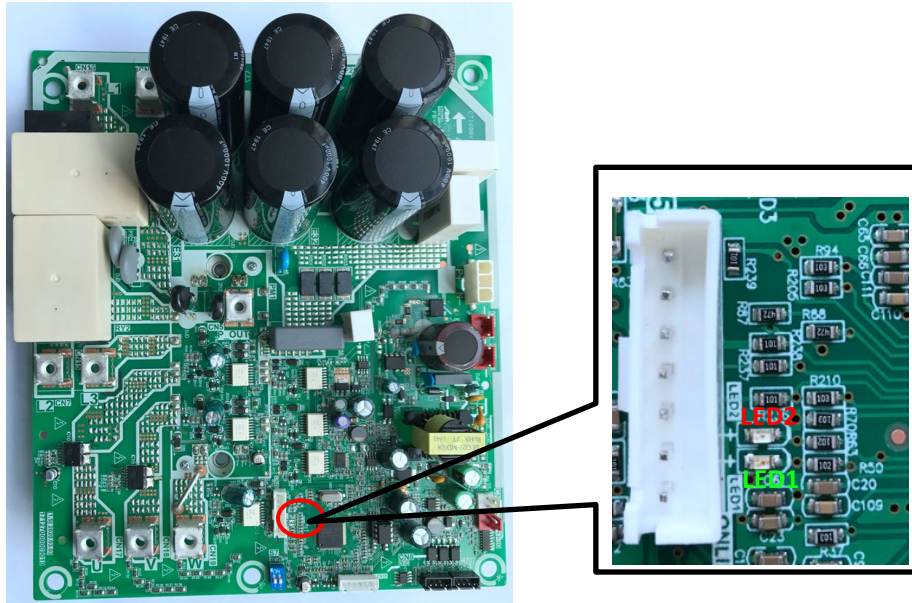

Figure 6-2.5: 14-18HP LED indicators LED1 and LED2 on inverter module

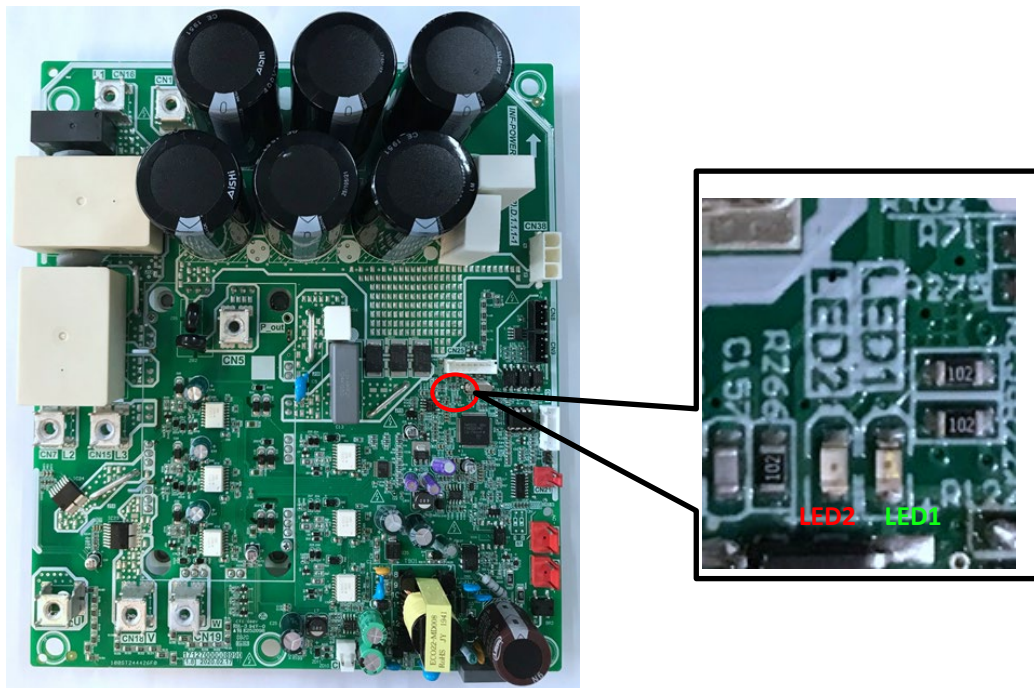
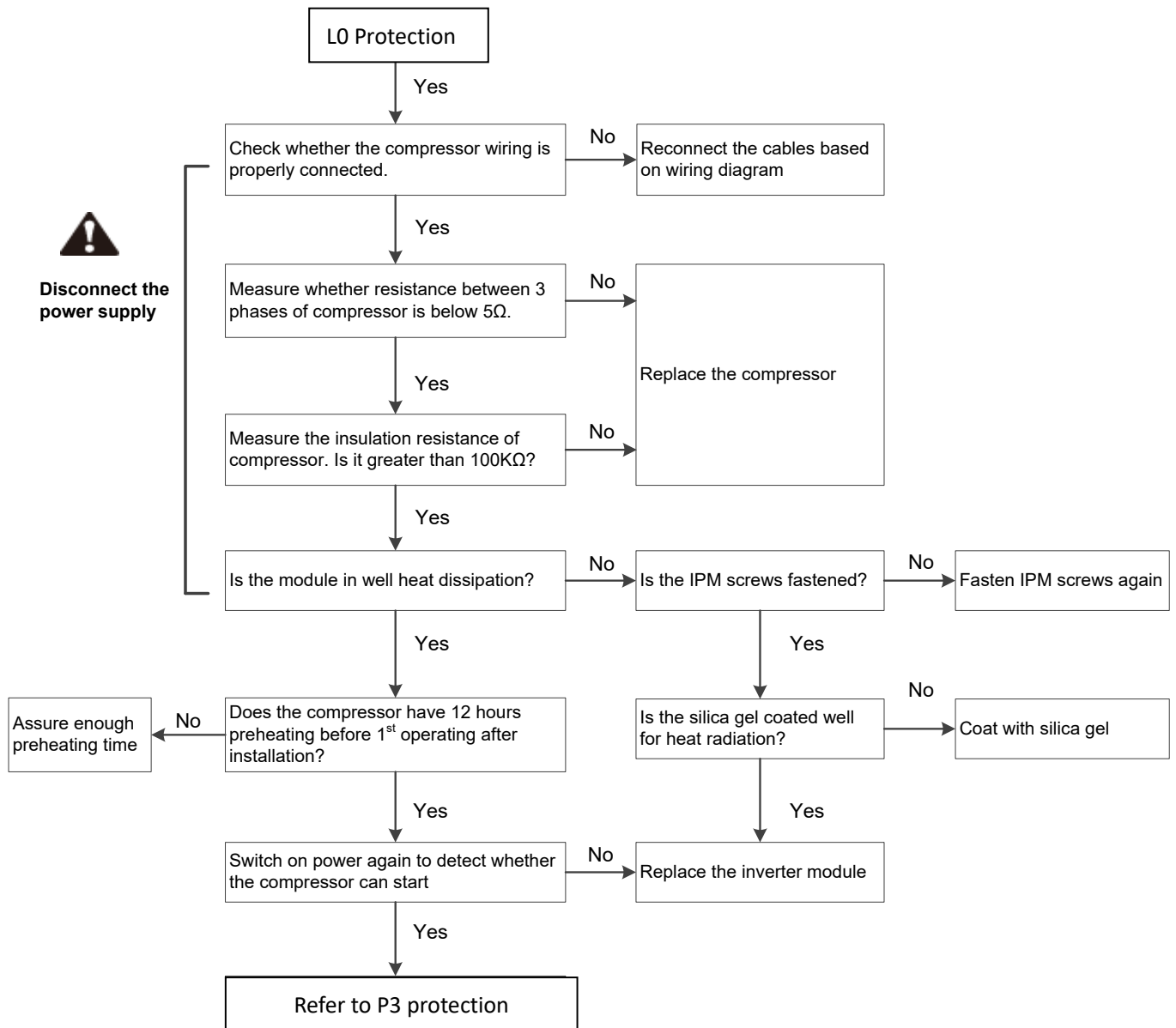

Table 5-3.2: Errors indicated on LED1

LED1 flashing pattern	Corresponding error
Flashes 8 times and stops for 1 second, then repeats	L0 - Inverter compressor module error
Flashes 9 times and stops for 1 second, then repeats	L1 - DC bus low voltage protection
Flashes 10 times and stops for 1 second, then repeats	L2 - DC bus high voltage protection
Flashes 13 times and stops for 1 second, then repeats	L5 - Zero speed protection
Flashes 15 times and stops for 1 second, then repeats	L7 - Phase sequence error
Flashes 11 times and stops for 1 second, then repeats	LA - PED software verification failed

2.14.6 L0: Inverter module protection



2.14.7 L1: DC bus low voltage protection

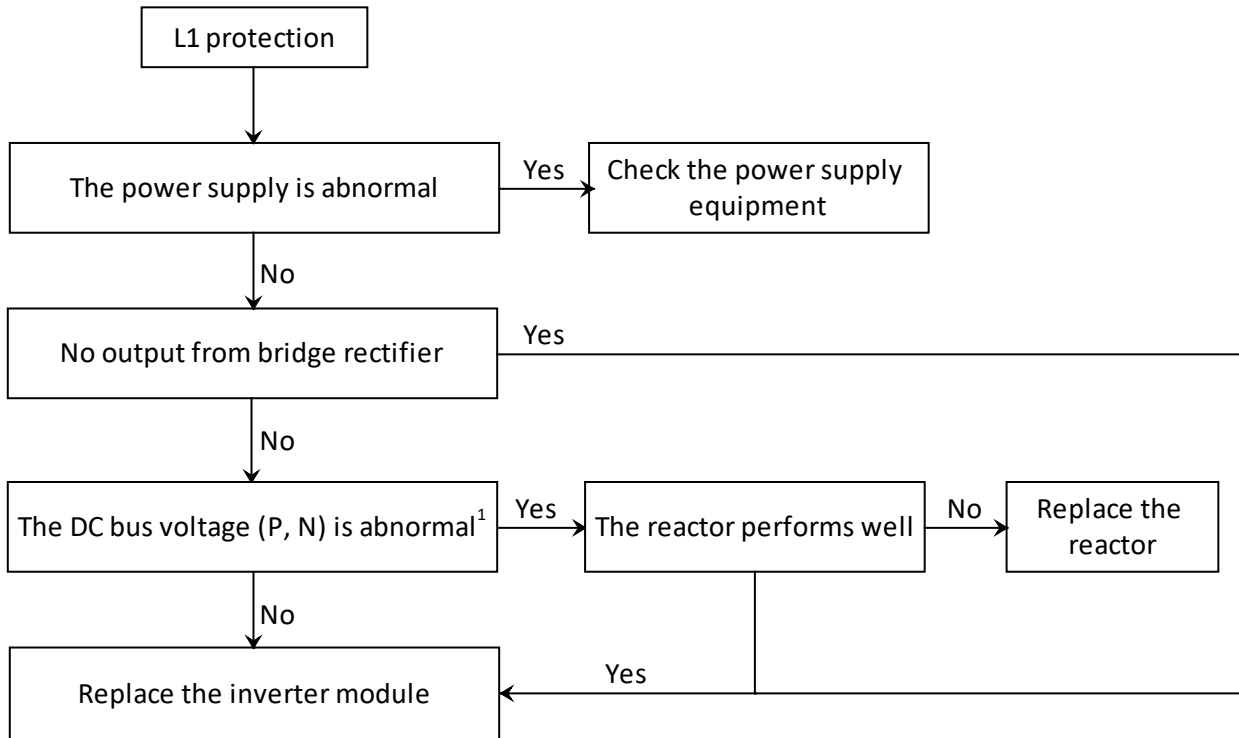

- Note:
- The normal DC voltage between terminals P and N on inverter module should be 450-650V. When the voltage is lower than 320V, L1 protection will be appeared.

Figure 6-2.6: Inverter module terminals

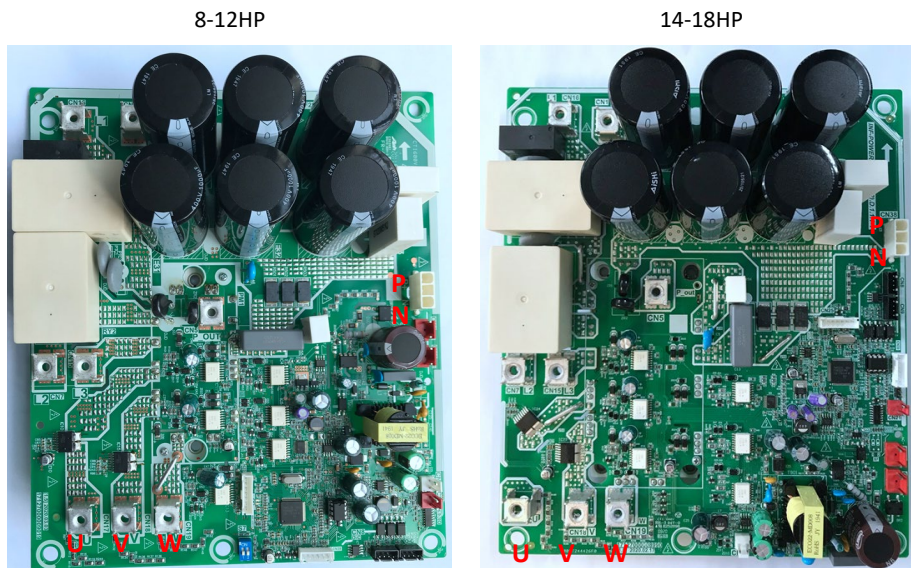

2.14.8 L2: DC bus high voltage protection

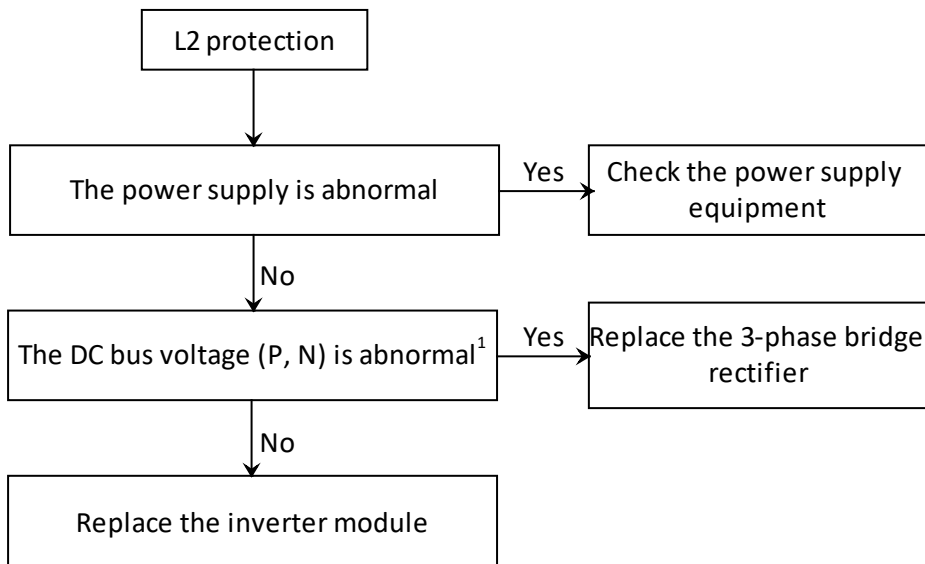

- Note:
1. The normal DC voltage between terminals P and N on inverter module should be 450-650V. When the voltage is higher than 700V, L2 protection will be appeared.

Figure 6-2.7: Inverter module terminals

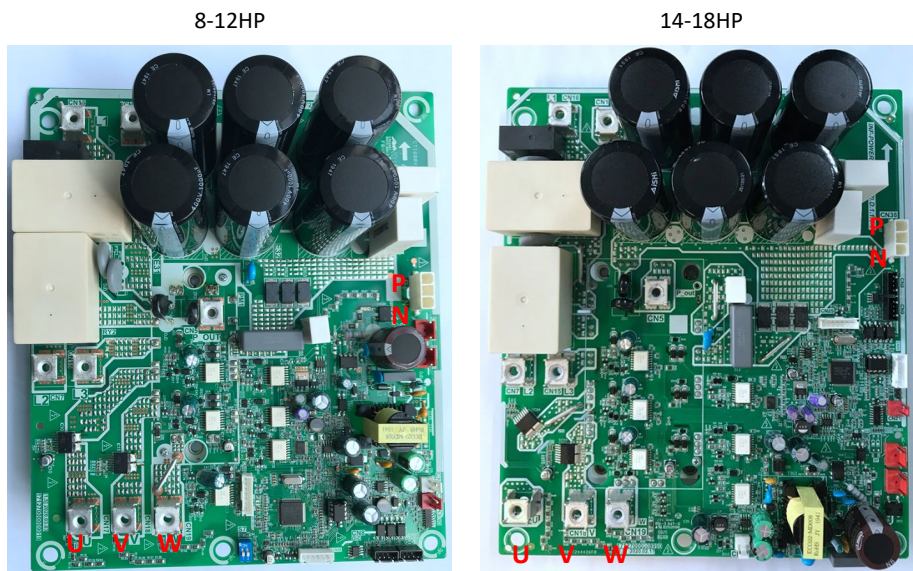

2.14.9 L5: Zero speed protection

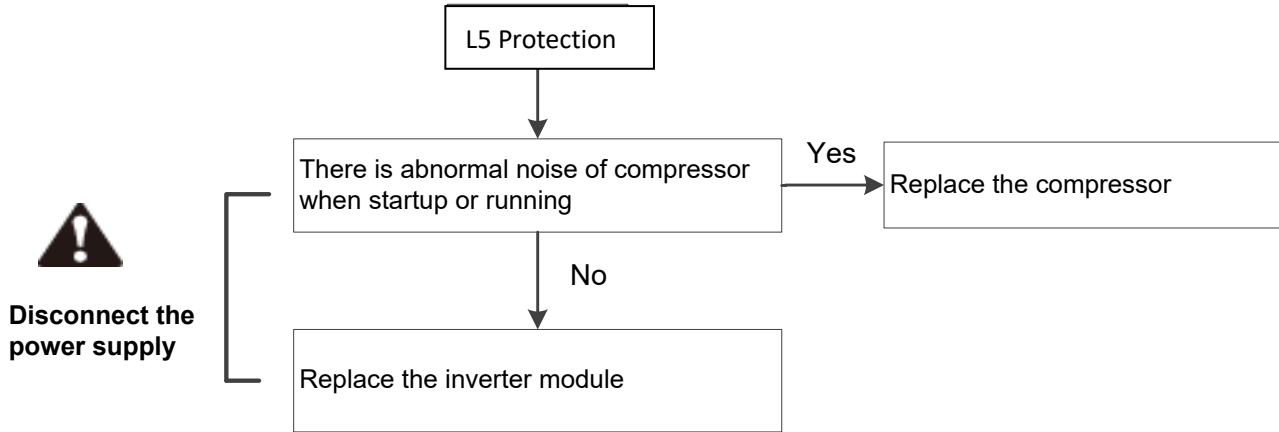

2.14.10 L7: Phase sequence error

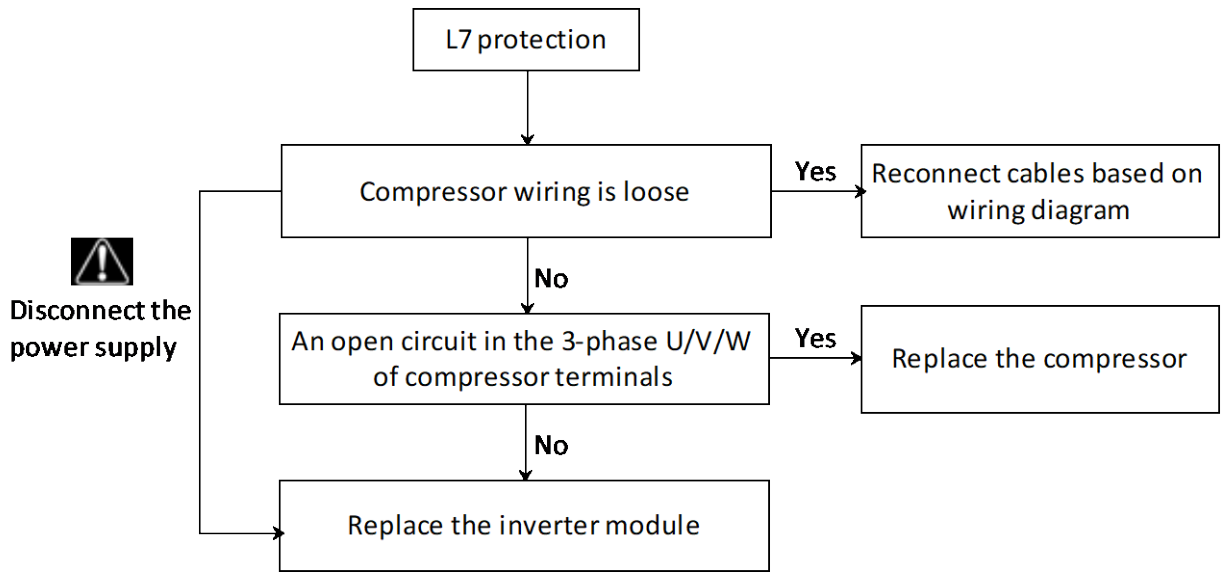

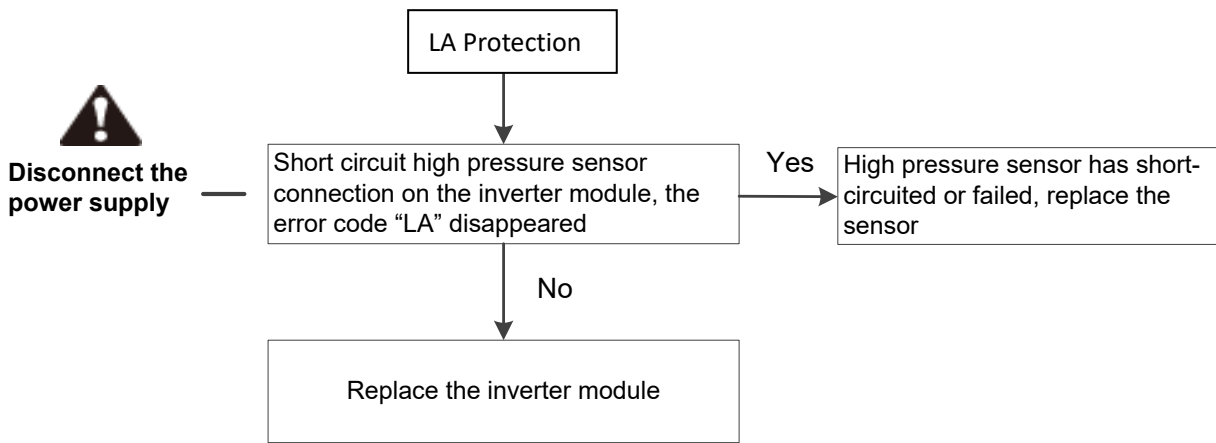
2.14.11 LA: PED software verification failed**Notes**

1. The high pressure sensor connection is port CN21 on the inverter module.

2.14.12 Compressor replacement procedure

Step 1: Remove faulty compressor and remove oil

- Remove the faulty compressor from the outdoor unit.
- Before removing the oil, shake the compressor so as to not allow impurities to remain settled at the bottom.
- Drain the oil out of the compressor and retain it for inspection. Normally the oil can be drained out from the compressor discharge pipe.

Figure 6-2.8: Draining oil from a compressor



Step 2: Inspect oil from faulty compressor

- The oil should be clear and transparent. Slightly yellow oil is not an indication of any problems. However, if the oil is dark, black or contains impurities, the system has problems and the oil needs to be changed. Refer to Figure 5-4.16 for further details regarding inspecting compressor oil. (If the compressor oil has been spoiled, the compressor will not be being lubricated effectively. The scroll plate, crankshaft and bearings will wear. Abrasion will lead to a larger load and higher current. More electric energy will get dissipated as heat and the temperature of the motor will become increasingly high. Finally, compressor damage or burnout will result.)

Step 3: Check oil in other compressors in the system

- If the oil drained from the faulty compressor is clean, go to Step 6.
- If the oil drained from the faulty compressor is only lightly spoiled, go to Step 4.
- If the oil drained from the faulty compressor is heavily spoiled, check the oil in the other compressors in the system. Drain the oil from any compressors where the oil has been spoiled. Go to Step 4.

Step 4: Replace oil separator(s) and accumulator(s)

- If the oil from a compressor is spoiled (lightly or heavily), drain the oil from the oil separator and accumulator in that unit and then replace them.

Step 5: Check filters(s)

- If the oil from a compressor is spoiled (lightly or heavily), check the filter between the gas stop valve and the 4-way valve in that unit. If it is blocked, clean with nitrogen or replace.

Step 6: Replace the faulty compressor and re-fit the other compressors

- Replace the faulty compressor.
- If the oil had been spoiled and was drained from the non-faulty compressors in Step 3, use clean oil to clean them before re-fitting them into the units. To clean, add oil into the compressor through the discharge pipe using a funnel, shake the compressor, and then drain the oil. Repeat several times and then re-fit the compressors into the units. (The discharge pipe is connected to the oil pool of the compressor by the inner oil balance pipe.)

Figure 6-2.9: Compressor piping

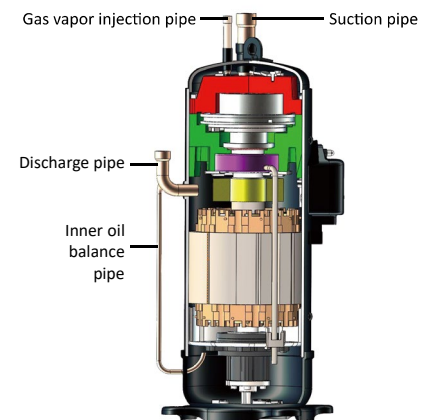

Step 7: Add compressor oil

- Add 1.1L of oil to each of the compressors from which oil was drained in Step 3.
- Only use FTVR ULTRA HR8H oil. Different compressors require different types of oil. Using the wrong type of oil leads to various problems.
- Add additional oil to the accumulators such that the total amount of oil is 5L in 8-12HP units, 6L in 14-18HP units.

Step 8: Vacuum drying and refrigerant charging

- Once all the compressors and other components have been fully connected, vacuum dry the system and recharge refrigerant. Refer to the TVR ULTRA HR Engineering Data Book, Part 3.

Figure 6-2.10: Inspecting compressor oil

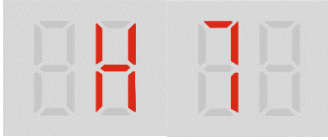

Figure 6-2.11: Effects of spoiled compressor oil



2.15 H7: Qty. of indoor units mismatching

2.15.1 Digital display output



2.15.2 Description

- Number of indoor units detected by master unit not same as number set on outdoor main PCB.
- All units stop running.
- Error code is only displayed on the master unit.

2.15.3 Trigger / recover condition

- Trigger condition: One or more indoor units cannot be detected by master unit for 20 minutes.
- Recover condition: Number of indoor units detected by master unit is same as number set on outdoor main PCB for 1minute.
- Reset method: Resume automatically.

2.15.4 Possible causes

- Number of indoor units set on outdoor main PCB not same as actual number of indoor units.
- Some indoor units are powered off.
- Communication wires between indoor and outdoor units not connected properly.
- Indoor unit PCB damaged.
- Indoor unit without address or indoor unit address duplicated.
- Outdoor main PCB damaged.

2.15.5 Procedure

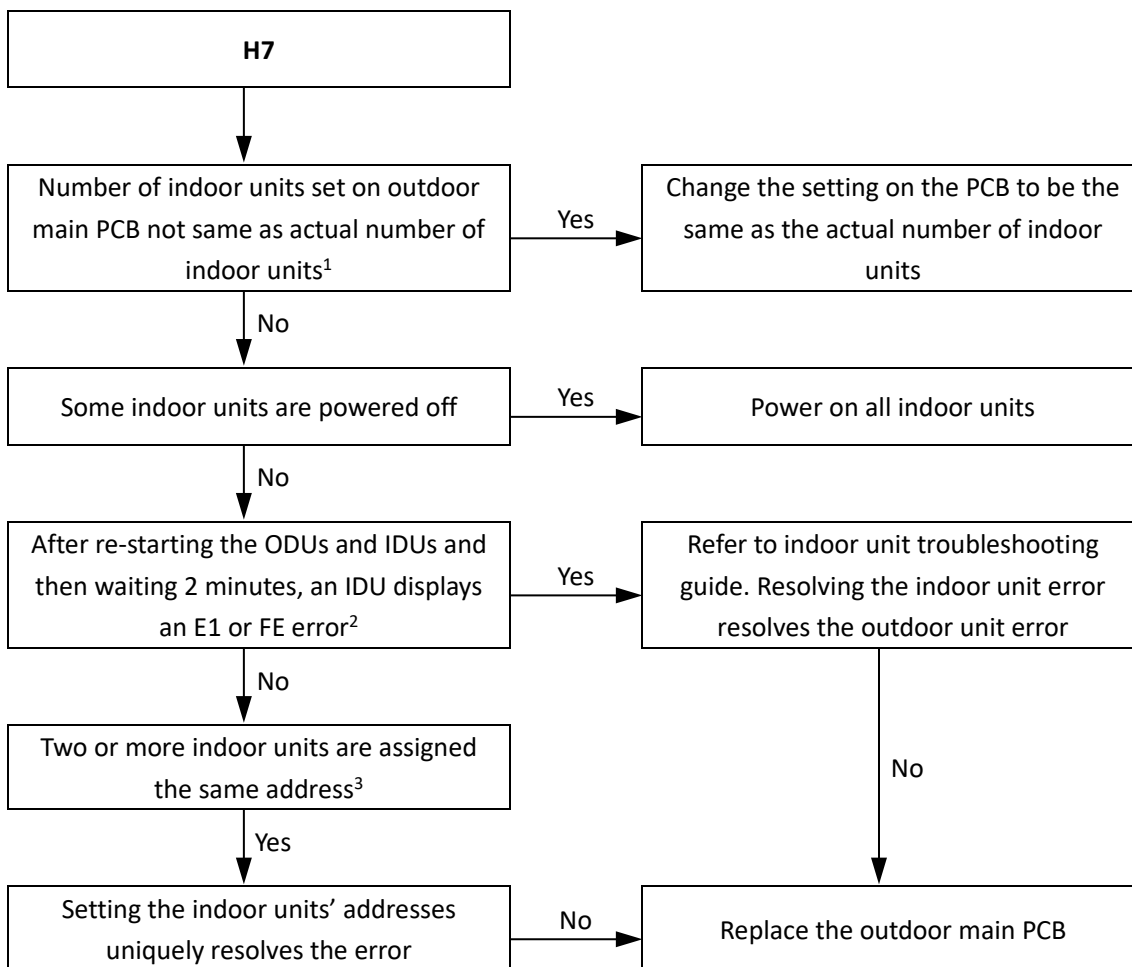

Notes:

1. The number of indoor units can be set on switches ENC3 and S12 on the outdoor main PCB.
2. Indoor unit error code E1 indicates a communication error between indoor and master outdoor unit. Indoor unit error code FE indicates that an indoor unit has not been assigned an address.
3. Indoor unit addresses can be checked and manually assigned using indoor unit remote/wired controllers. Alternatively, indoor unit addresses can be automatically assigned by the master outdoor unit.

2.16 H8: High pressure sensor error

2.16.1 Digital display output

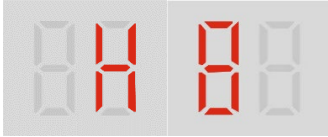

2.16.2 Description

- High pressure sensor error.
- All units stop running.
- Error code is displayed on the unit with the error.

2.16.3 Trigger / recover condition

- Trigger condition: Discharge pressure $\leq 0.3\text{MPa}$ and $T_4 \geq -10^\circ\text{C}$ for a consecutive of 20s or Discharge pressure $\leq 0.3\text{MPa}$ and compressor operates for a consecutive of 20s
- Recover condition: Does not meet the above conditions.
- Reset method: Resume automatically.

2.16.4 Possible causes

- Outdoor unit stop valves are closed.
- Pressure sensor not connected properly or has malfunction.
- Insufficient refrigerant.
- Low pressure side blockage.
- Poor evaporator heat exchange.
- Outdoor main PCB damaged.

2.16.5 Procedure

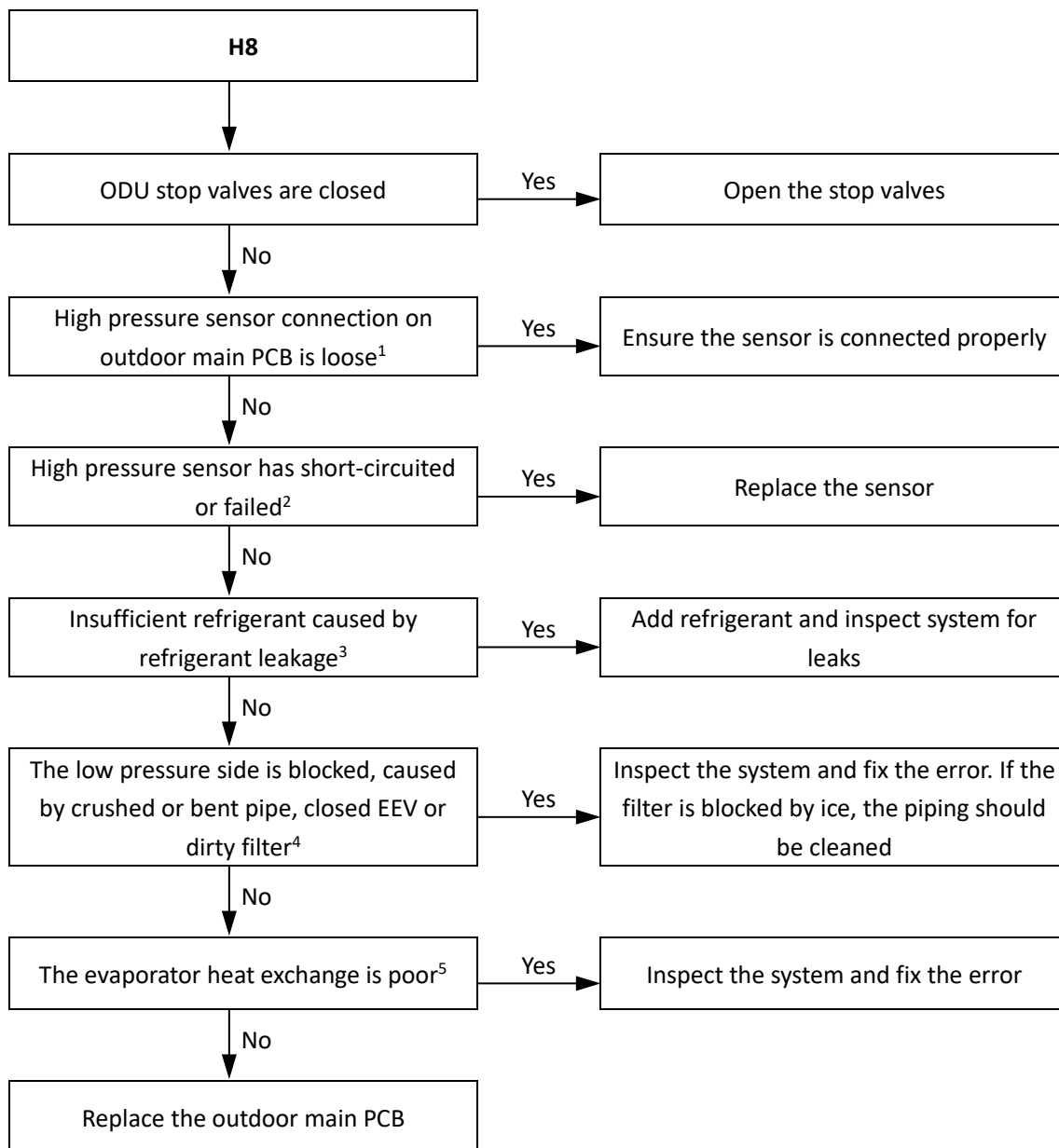

Notes:

1. High pressure sensor connection is port CN17 on the outdoor main PCB.
2. Measure the resistance among the three terminals of the pressure sensor. If the resistance is of the order of mega Ohms or infinite, the pressure sensor has failed.
3. An insufficiency of refrigerant causes compressor discharge temperature to be higher than normal, discharge and suction pressures to be lower than normal and compressor current to be lower than normal, and may cause frosting to occur on the suction pipe. These issues disappear once sufficient refrigerant has been charged into the system.
4. A low pressure side blockage causes compressor discharge temperature to be higher than normal, suction pressure to be lower than normal and compressor current to be lower than normal, and may cause frosting to occur on the suction pipe.
5. In cooling mode check indoor heat exchangers, fans and air outlets for dirt/blockages. In heating mode check outdoor heat exchangers, fans and air outlets for dirt/blockages.

2.17 Hb: Low pressure sensor error

2.17.1 Digital display output

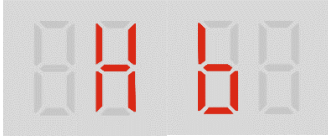

2.17.2 Description

- Low pressure sensor error.
- All units stop running.
- Error code is displayed on the unit with the error.

2.17.3 Trigger / recover condition

- Trigger condition: The main control board cannot receive the feedback signal of low pressure sensor.
- Recover condition: The main control board can receive the feedback signal of low pressure sensor.
- Reset method: Resume automatically.

2.17.4 Possible causes

- Outdoor unit Low gas stop valves are closed.
- Pressure sensor not connected properly or has malfunction.
- Outdoor main PCB damaged.

2.17.5 Procedure

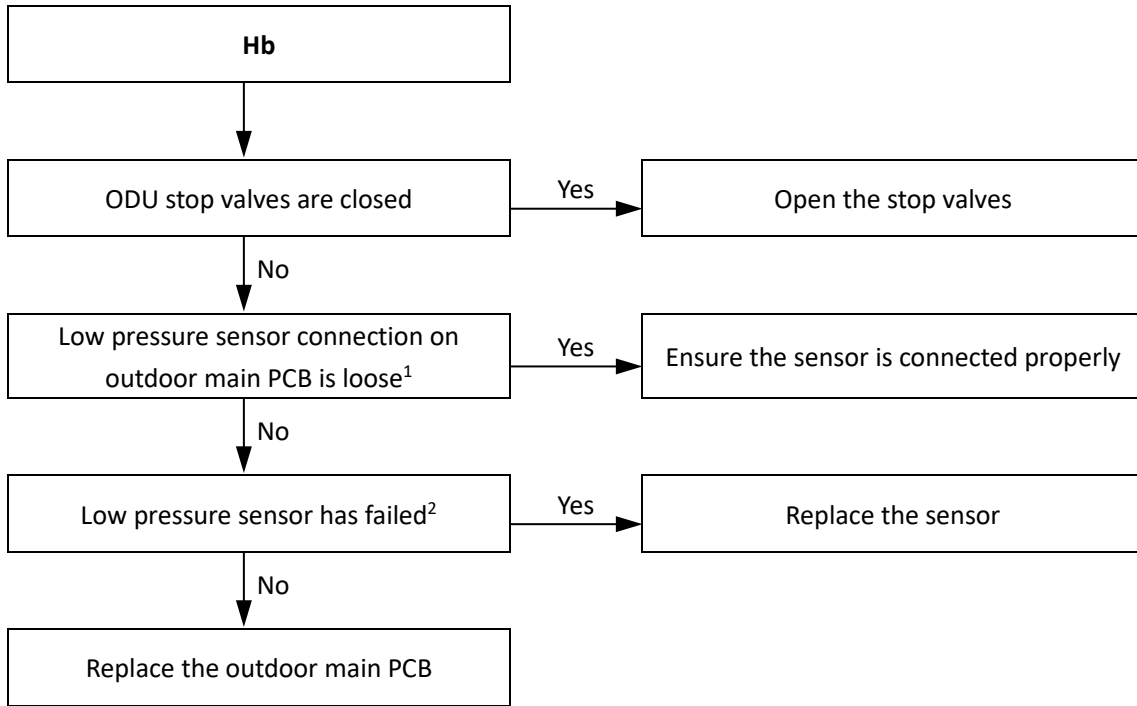

Notes:

1. High pressure sensor connection is port CN17 on the outdoor main PCB.
2. Measure the resistance among the three terminals of the pressure sensor. If the resistance is of the order of mega Ohms or infinite, the pressure sensor has failed.

2.18 yHd: Slave unit malfunction

2.18.1 Digital display output

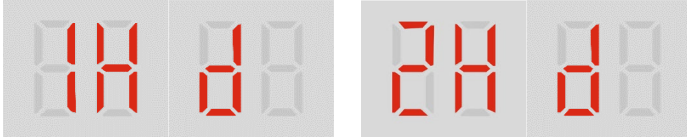

In the error code, 'y' is a placeholder for the address (1, 2) of the slave unit with the error.

2.18.2 Description

- 1Hd indicates an error on the slave unit with address 1.
- 2Hd indicates an error on the slave unit with address 2.
- All units stop running.
- Error code is only displayed on the master unit.

2.18.3 Trigger / recover condition

- Trigger condition: Slave unit is malfunction.
- Recover condition: Slave unit goes back to normal.
- Reset method: Resume automatically.

2.18.4 Possible causes

- Slave unit malfunction.

2.18.5 Procedure

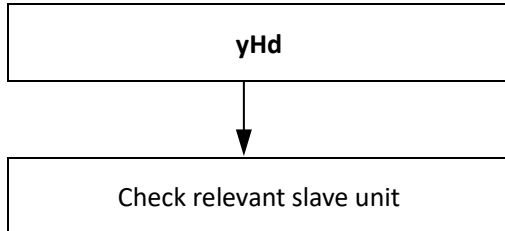

2.19 P1: High pressure protection

2.19.1 Digital display output

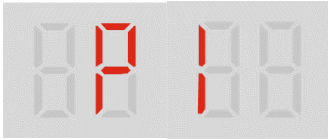

2.19.2 Description

- All units stop running.
- Error code is displayed on the unit with the error.

2.19.3 Trigger / recover condition

➤ High pressure sensor protection

- Trigger condition: Discharge pressure ≥ 3.9 MPa.
- Recover condition:
 - Cooling Only/Main Cooling Discharge pressure < 3.5 MPa and Restart permission=ON.
 - Heating Only/Main Heating Discharge pressure < 3.1 MPa and Restart permission=ON.
- Reset method: Resume automatically.

➤ Discharge pressure switch protection

- Trigger condition: Discharge pressure ≥ 4.0 MPa.
- Recover condition: Discharge pressure < 3.0 MPa.

2.19.4 Possible causes

- Outdoor unit stop valves are closed.
- Pressure sensor/switch not connected properly or has malfunction.
- Excess refrigerant.
- System contains air or nitrogen.
- High pressure side blockage.
- Poor condenser heat exchange.
- Outdoor main PCB damaged.

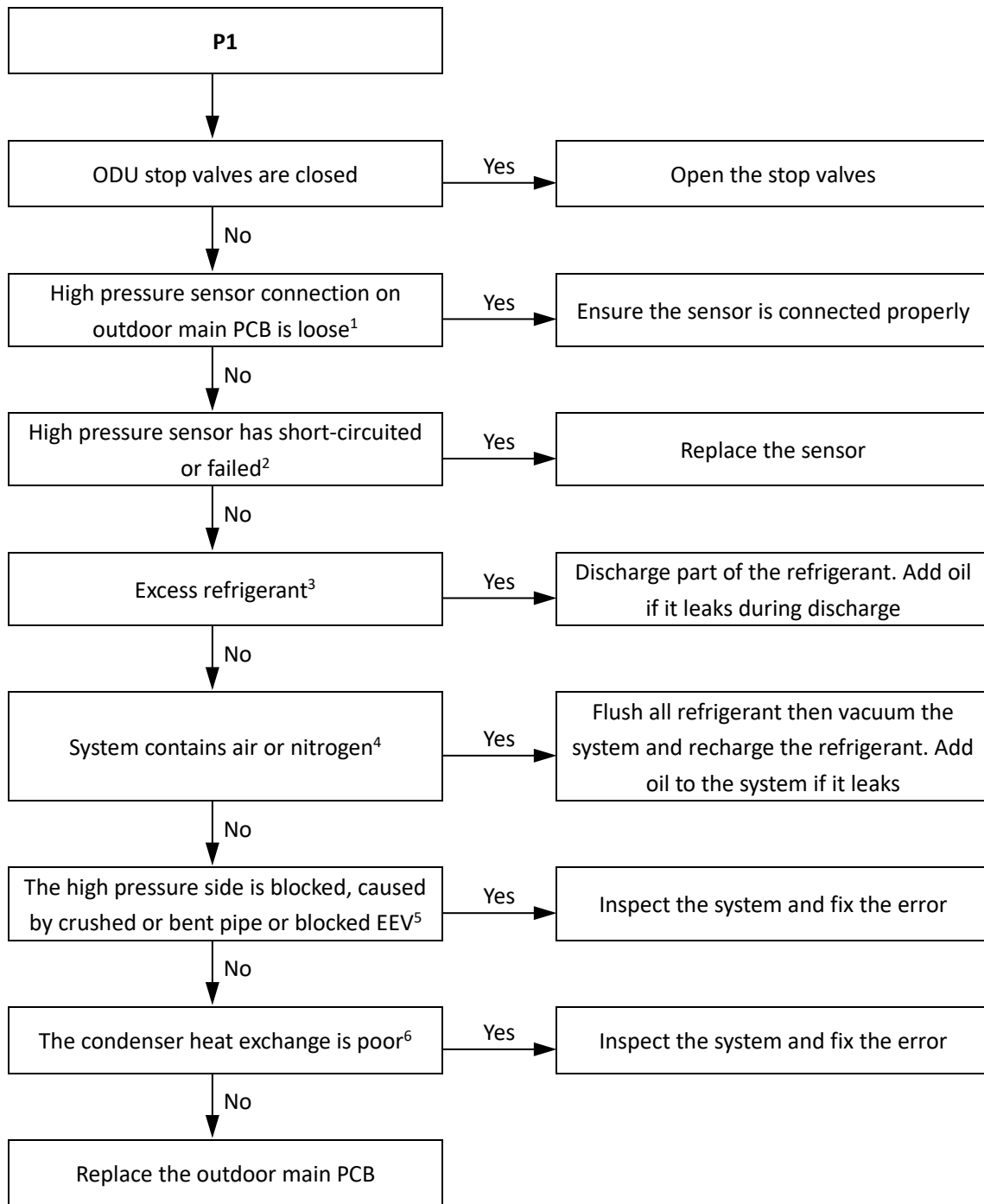
2.19.5 Procedure

Notes:

1. The high pressure sensor connection is port CN17 on the outdoor main PCB.
2. Measure the resistance among the three terminals of the pressure sensor. If the resistance is of the order of mega Ohms or infinite, the pressure sensor has failed.
3. Excess refrigerant causes discharge temperature to be lower than normal, discharge pressure to be higher than normal and suction pressure to be higher than normal.
4. Air or nitrogen in the system causes discharge temperature to be higher than normal, discharge pressure to be higher than normal, compressor current to be higher than normal, abnormal compressor noise and an unsteady pressure meter reading.
5. High pressure side blockage causes discharge temperature to be higher than normal, discharge pressure to be higher than normal and suction pressure to be lower than normal.
6. In cooling mode check outdoor heat exchangers, fans and air outlets for dirt/blockages. In heating mode check indoor heat exchangers, fans and air outlets for dirt/blockages.

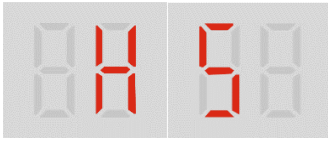
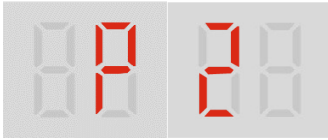
2.20 P2, H5: Suction pipe low pressure protection



2.20.1 Description

- All units stop running.
- Error code is displayed on the unit with the error.

2.20.2 Trigger / recover condition

- Trigger condition:
For P2 protection: Suction pressure < 0.07MPa.
For H5 protection: P2 protection appears three times in 60 minutes.
- Recover condition:
 - Cooling Only/Main Cooling Discharge pressure \geq 0.23MPa and Restart permission=ON.
 - Heating Only/Main Heating Discharge pressure \geq 0.18MPa and Restart permission=ON.
- Reset method:
For P2 protection: Resume automatically.
For H5 protection: Manually restart.

2.20.3 Possible causes

- Outdoor unit stop valves are closed.
- Insufficient refrigerant.
- Low pressure side blockage.
- Poor evaporator heat exchange.
- Outdoor main PCB damaged.

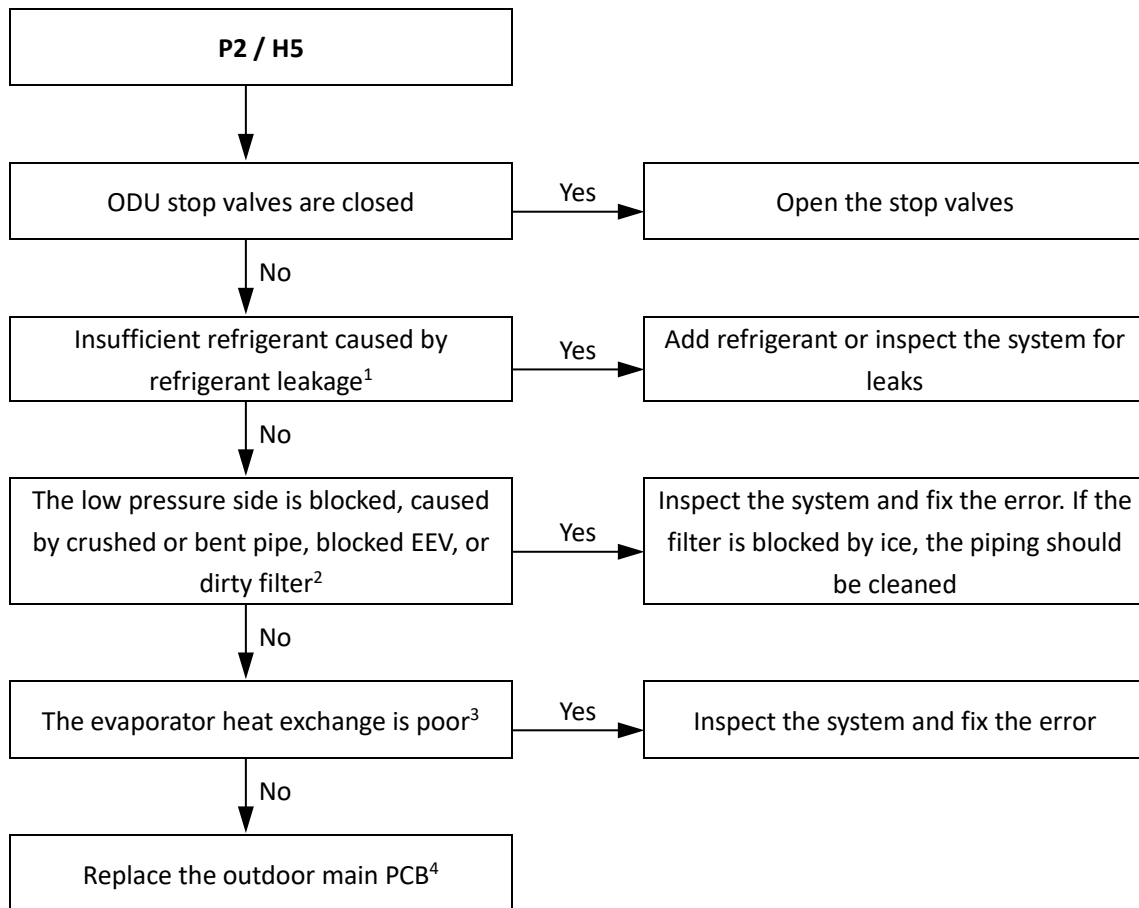
2.20.4 Procedure

Notes:

1. An insufficiency of refrigerant causes compressor discharge temperature to be higher than normal, discharge and suction pressures to be lower than normal and compressor current to be lower than normal, and may cause frosting to occur on the suction pipe. These issues disappear once sufficient refrigerant has been charged into the system.
2. A low pressure side blockage causes compressor discharge temperature to be higher than normal, suction pressure to be lower than normal and compressor current to be lower than normal, and may cause frosting to occur on the suction pipe.
3. In cooling mode check indoor heat exchangers, fans and air outlets for dirt/blockages. In heating mode check outdoor heat exchangers, fans and air outlets for dirt/blockages.
4. The low pressure sensor connection is port CN16 on the outdoor main PCB.

2.21 P31: Primary current protection

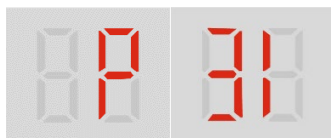
2.21.1 Digital display output



2.21.2 Description

- All units stop running.
- Error code is displayed on the unit with the error.

2.21.3 Trigger / recover condition

- Trigger condition: Refer to Part 3 6.4 Over-current Protection Control
- Recover condition: Refer to Part 3 6.4 Over-current Protection Control
- Reset method: Resume automatically.

2.21.4 Possible causes

- Outdoor unit stop valves are closed.
- Indoor load too large.
- Power supply abnormal.
- Sudden interruption of power to IDUs.
- Excess refrigerant.
- System contains air or nitrogen.
- Poor condenser heat exchange.
- High pressure side blockage.
- Inverter module damaged.
- Compressor damaged.
- Outdoor main PCB damaged.
- DC fan drive board damaged.

2.21.5 Procedure

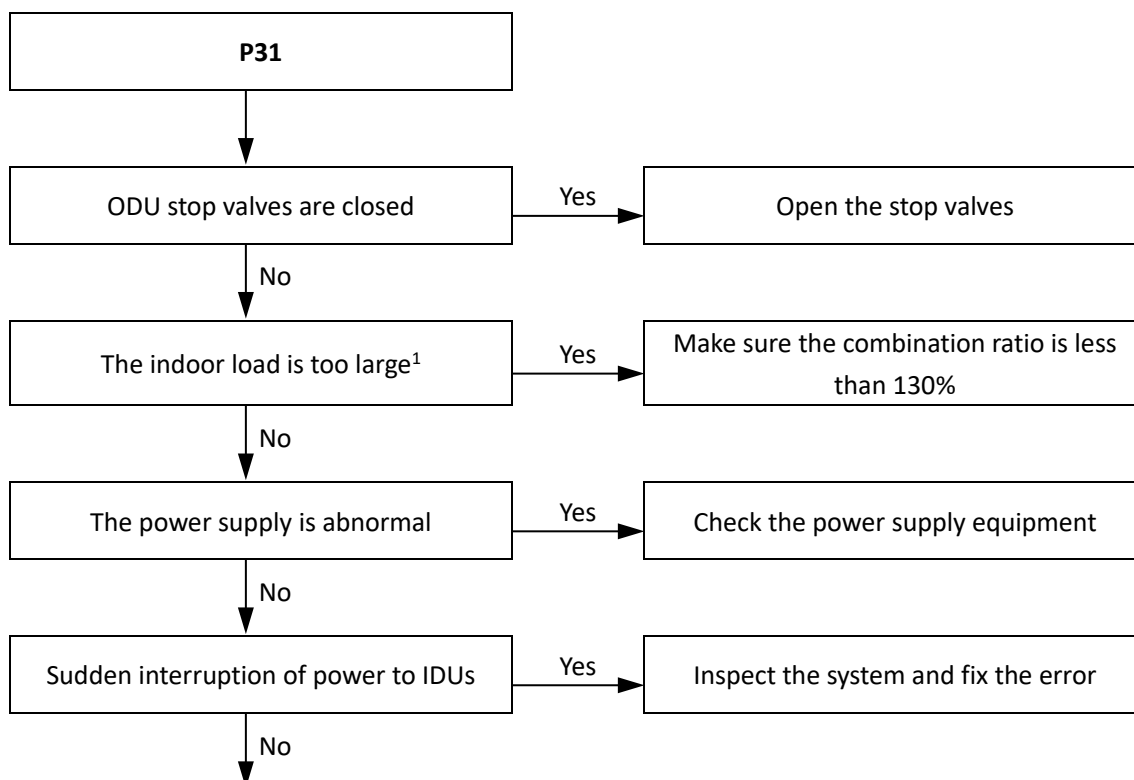

Flowchart continued on next page ...

... flowchart continued from previous page

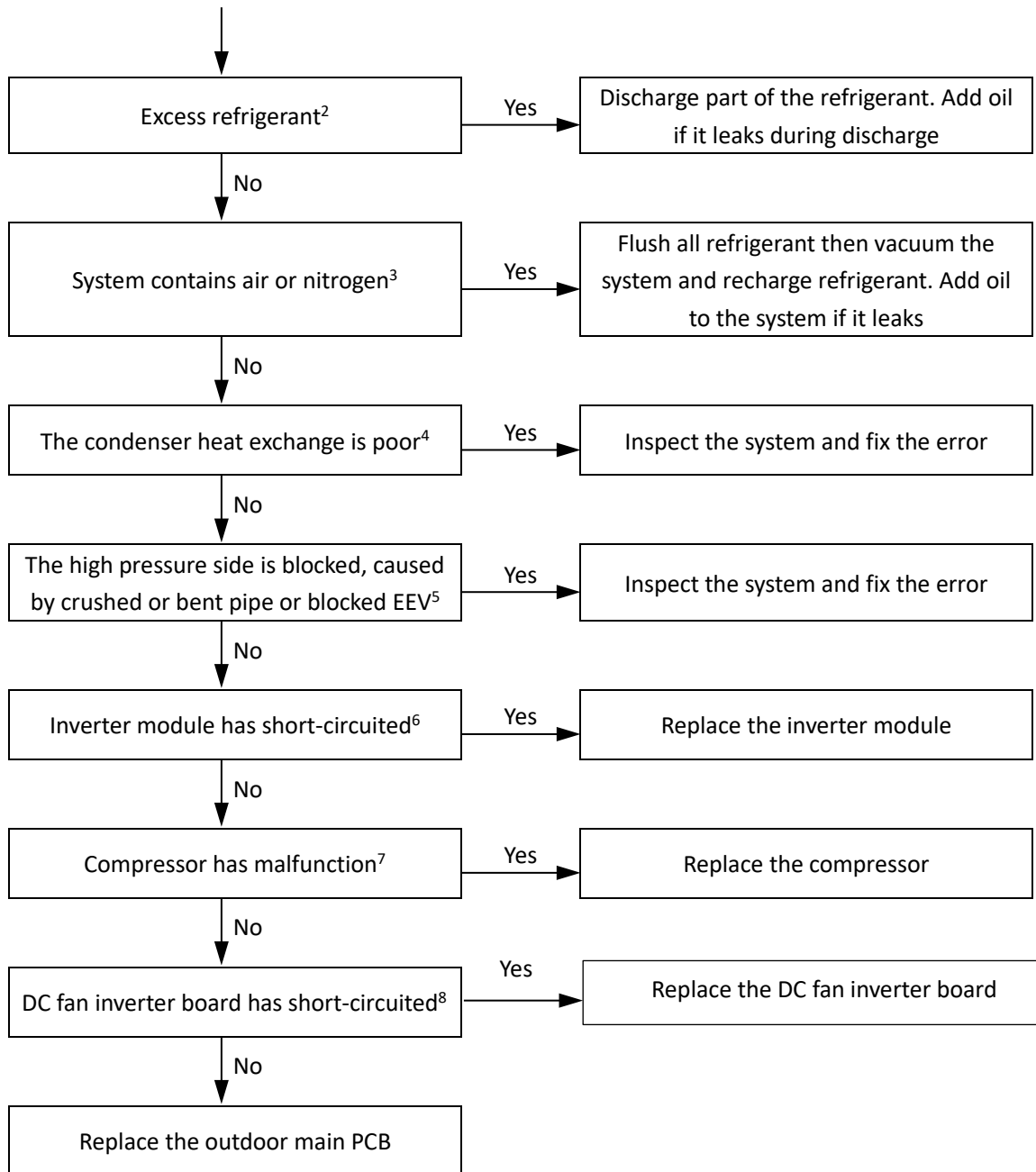

Notes:

1. An indoor load that is too large causes suction and discharge temperatures to be higher than normal.
2. Excess refrigerant causes discharge temperature to be lower than normal, discharge pressure to be higher than normal and suction pressure to be higher than normal. For excess refrigerant system parameters refer to Table 6-4.4 in Part 6, 4.3 "Parameters of Excess and Insufficient Refrigerant System".
3. Air or nitrogen in the system causes discharge temperature to be higher than normal, discharge pressure to be higher than normal, compressor current to be higher than normal, abnormal compressor noise and an unsteady pressure meter reading. For insufficient refrigerant system parameters refer to Table 6-4.5 in Part 6, 4.3 "Parameters of Excess and Insufficient Refrigerant System".
4. In cooling mode check outdoor heat exchangers, fans and air outlets for dirt/blockages. In heating mode check indoor heat exchangers, fans and air outlets for dirt/blockages.
5. High pressure side blockage causes discharge temperature to be higher than normal, discharge pressure to be higher than normal and suction pressure to be lower than normal. For insufficient refrigerant system parameters refer to Table 6-4.5 in Part 6, 4.3 "Parameters of Excess and Insufficient Refrigerant System".
6. Set a multi-meter to buzzer mode and test any two terminals of P N U V W of the inverter module. If the buzzer sounds, the inverter module has short-circuited.
7. The normal resistances of the inverter compressor are 0.05-0.15Ω among U V W and infinite between each of U V W and ground. If any of the resistances differ from these specifications, the compressor has malfunction.
8. Set a multi-meter to buzzer mode and test any two terminals of P N U V W of the DC fan drive board. If the buzzer sounds, the DC fan drive board has short-circuited.

2.22 P32: Secondary current protection

2.22.1 Digital display output

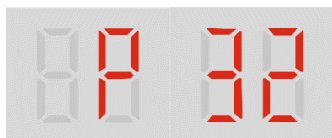

2.22.2 Description

- All units stop running.
- Error code is displayed on the unit with the error.

2.22.3 Trigger / recover condition

- Trigger condition: Refer to Part 3 6.4 Over-current Protection Control
- Recover condition: Refer to Part 3 6.4 Over-current Protection Control
- Reset method: Resume automatically.

2.22.4 Possible causes

- Outdoor unit stop valves are closed.
- Indoor load too large.
- Power supply abnormal.
- Sudden interruption of power to IDUs.
- Excess refrigerant.
- System contains air or nitrogen.
- Poor condenser heat exchange.
- High pressure side blockage.
- Inverter module damaged.
- Compressor damaged.
- Outdoor main PCB damaged.

2.22.5 Procedure

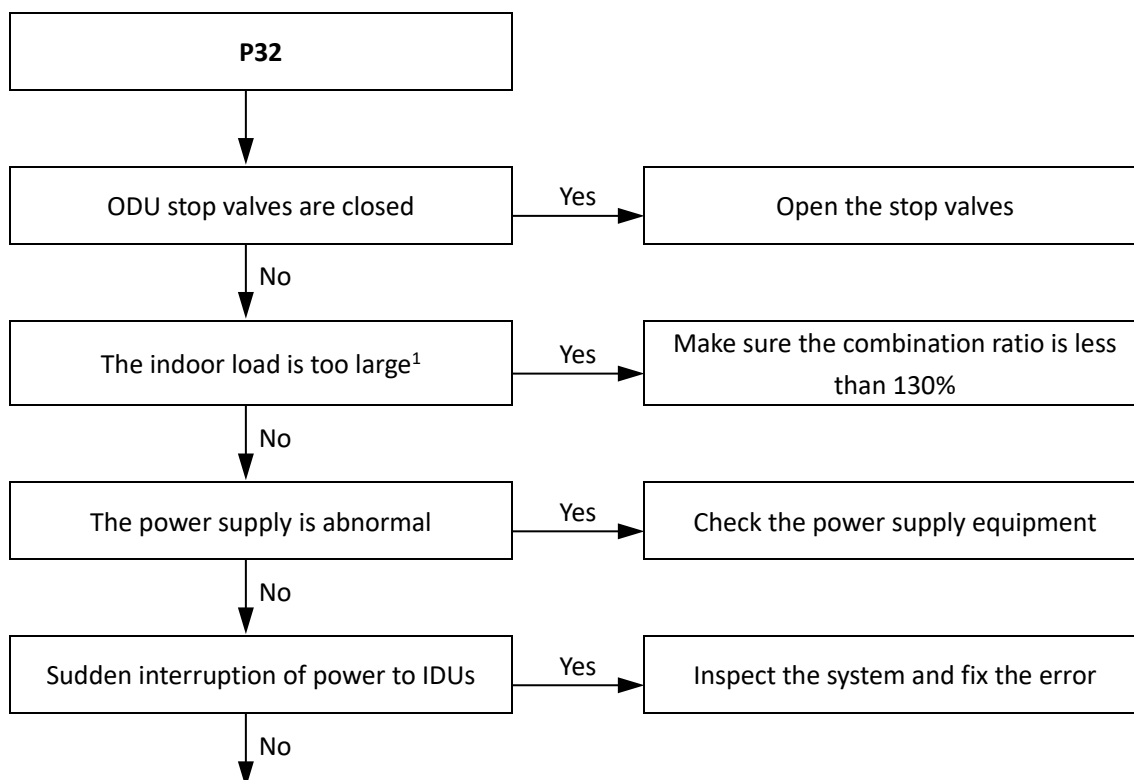

Flowchart continued on next page ...

... flowchart continued from previous page

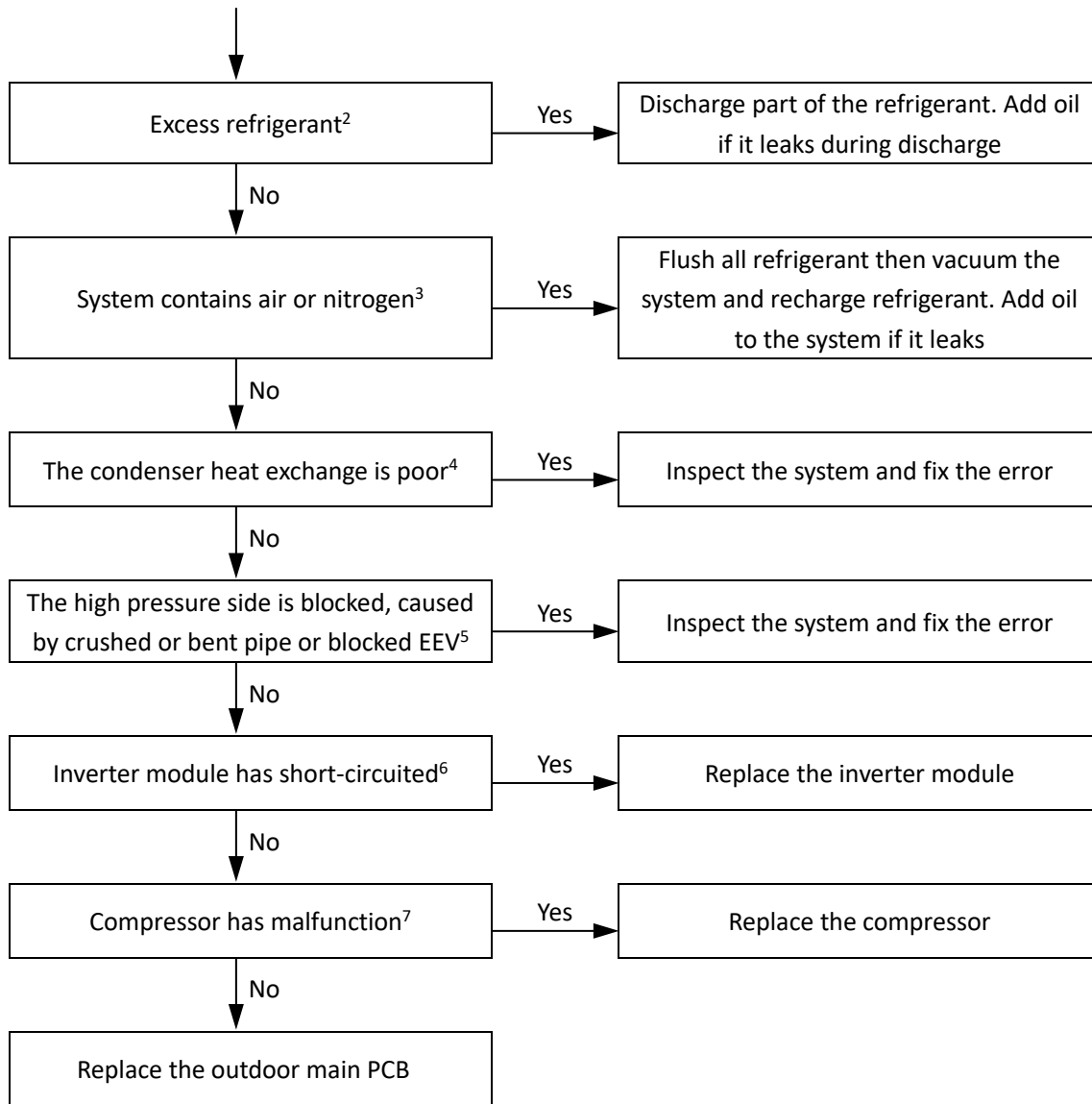

Notes:

1. An indoor load that is too large causes suction and discharge temperatures to be higher than normal. For normal system parameters refer to Table 6-4.4 and 6-4.5 in Part 6, 4.2 "Normal Operating Parameters of Refrigerant System".
2. Excess refrigerant causes discharge temperature to be lower than normal, discharge pressure to be higher than normal and suction pressure to be higher than normal. For normal system parameters refer to Table 6-4.4 and 6-4.5 in Part 6, 4.2 "Normal Operating Parameters of Refrigerant System".
3. Air or nitrogen in the system causes discharge temperature to be higher than normal, discharge pressure to be higher than normal, compressor current to be higher than normal, abnormal compressor noise and an unsteady pressure meter reading. For normal system parameters refer to Table 6-4.4 and 6-4.5 in Part 6, 4.2 "Normal Operating Parameters of Refrigerant System".
4. In cooling mode check outdoor heat exchangers, fans and air outlets for dirt/blockages. In heating mode check indoor heat exchangers, fans and air outlets for dirt/blockages.
5. High pressure side blockage causes discharge temperature to be higher than normal, discharge pressure to be higher than normal and suction pressure to be lower than normal. For normal system parameters refer to Table 6-4.4 and 6-4.5 in Part 6, 4.2 "Normal Operating Parameters of Refrigerant System".
6. Set a multi-meter to buzzer mode and test any two terminals of P N U V W of the inverter module. If the buzzer sounds, the inverter module has short-circuited.
7. The normal resistances of the inverter compressor are 0.05-0.15Ω among U V W and infinite between each of U V W and ground. If any of the resistances

2.23 P4, H6: Discharge temperature protection or discharge temperature switch protection

2.23.1 Digital display output

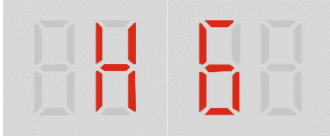
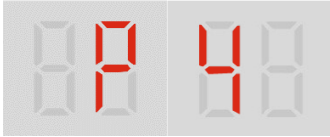

2.23.2 Description

- Discharge temperature protection.
- All units stop running.
- Error code is displayed on the unit with the error.

2.23.3 Trigger / recover condition

➤ Discharge temperature protection

- Trigger condition:
 - For P4 protection: Discharge temperature (T7C1) $\geq 115^{\circ}\text{C}$.
- Recover condition: Discharge temperature (T7C1) $< 90^{\circ}\text{C}$.
- Reset method:
 - For P4 protection: Resume automatically.

➤ Discharge Temp. switch protection

- Trigger condition: Discharge temperature $\geq 115^{\circ}\text{C}$.
- Recover condition: Discharge temperature $< 75^{\circ}\text{C}$.
- Reset method: Resume automatically.

➤ H6 protection

- For H6 protection: P4 protection appears three times in 100 minutes.
- Reset method:
 - For P4 protection: Resume automatically.
 - For H6 protection: Manually restart.

2.23.4 Possible causes

- | | | |
|--|-----------------------------|------------------------------------|
| ▪ Outdoor unit stop valves are closed. | ▪ Insufficient refrigerant. | ▪ System contains air or nitrogen. |
| ▪ Temperature sensor/switch not connected properly or has malfunction. | ▪ System blockage. | ▪ Poor condenser heat exchange. |
| | ▪ Indoor load too large. | ▪ Outdoor main PCB damaged. |

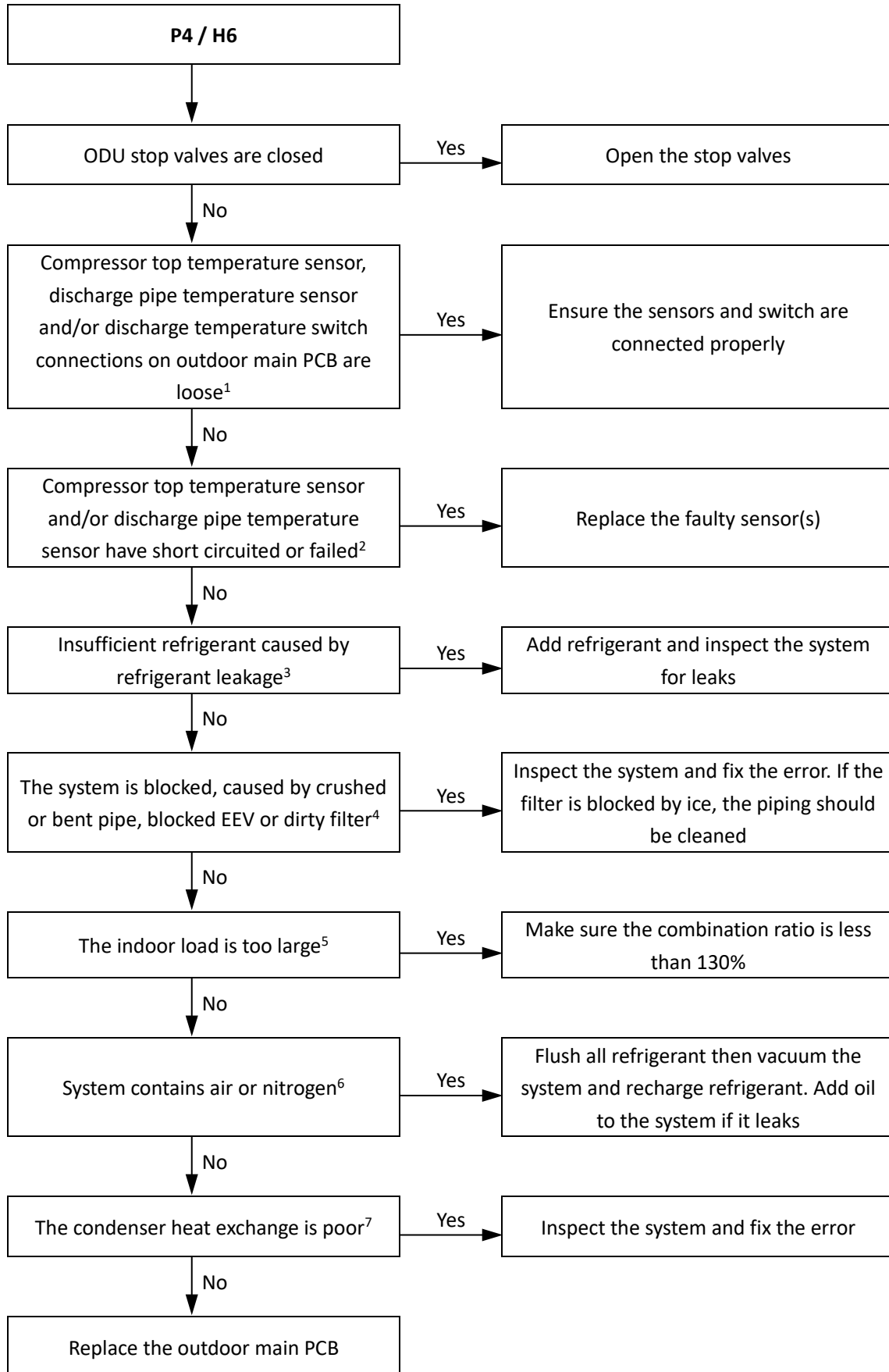
2.23.5 Procedure

Notes:

1. Compressor top temperature sensor and discharge pipe temperature sensor connections are ports CN4 on the outdoor main PCB. The discharge temperature switch connection is port CN18 on the outdoor main PCB.
2. Measure sensor resistance. If the resistance is too low, the sensor has short-circuited. If the resistance is not consistent with the sensor's resistance

characteristics table, the sensor has failed. Refer to Table 6-4.2 in Part 6, 4.1 "Temperature Sensor Resistance Characteristics".

3. An insufficiency of refrigerant causes compressor discharge temperature to be higher than normal, discharge and suction pressures to be lower than normal and compressor current to be lower than normal, and may cause frosting to occur on the suction pipe. These issues disappear once sufficient refrigerant has been charged into the system. For abnormal refrigerant system parameters refer to Table 6-4.4 and 6-4.5 in Part 6, 4.3 "Parameters of Excess and Insufficient Refrigerant System".
4. A low pressure side blockage causes compressor discharge temperature to be higher than normal, suction pressure to be lower than normal and compressor current to be lower than normal, and may cause frosting to occur on the suction pipe. For abnormal refrigerant system parameters refer to Table 6-4.4 and 6-4.5 in Part 6, 4.3 "Parameters of Excess and Insufficient Refrigerant System".
5. An indoor load that is too large causes suction and discharge temperatures to be higher than normal. For abnormal refrigerant system parameters refer to Table 6-4.4 and 6-4.5 in Part 6, 4.3 "Parameters of Excess and Insufficient Refrigerant System".
6. Air or nitrogen in the system causes discharge temperature to be higher than normal, discharge pressure to be higher than normal, compressor current to be higher than normal, abnormal compressor noise and an unsteady pressure meter reading. For abnormal refrigerant system parameters refer to Table 6-4.4 and 6-4.5 in Part 6, 4.3 "Parameters of Excess and Insufficient Refrigerant System".
7. In cooling mode check outdoor heat exchangers, fans and air outlets for dirt/blockages. In heating mode check indoor heat exchangers, fans and air outlets for dirt/blockages.

2.24 P9, H9: Fan module protection

2.24.1 Digital display output

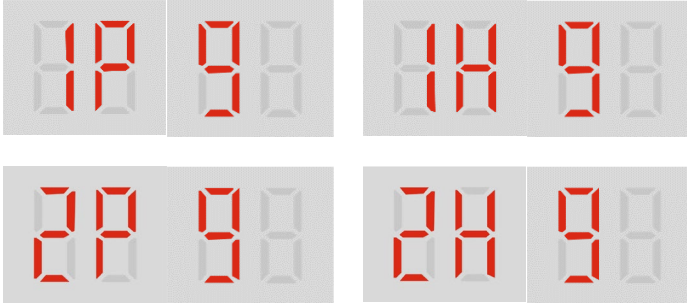

2.24.2 Description

- Fan module protection.
- All units stop running.
- Error code is displayed on the unit with the error.

2.24.3 Trigger / recover condition

- Trigger condition:
 - For P9 protection: Fan speed is too low.
 - For H9 protection: P9 protection appears ten times in 120 minutes.
- Recover condition: Fan speed go back to normal.
- Reset method:
 - For P9 protection: Resume automatically;
 - For H9 protection: Manually restart.

2.24.4 Possible causes

- Switch ENC2 incorrectly set.
- Power or communication wires not connected properly.
- Fan motor blocked or has failed.
- Power supply abnormal.
- Fan module damaged.
- Outdoor main PCB damaged.

2.24.5 Procedure

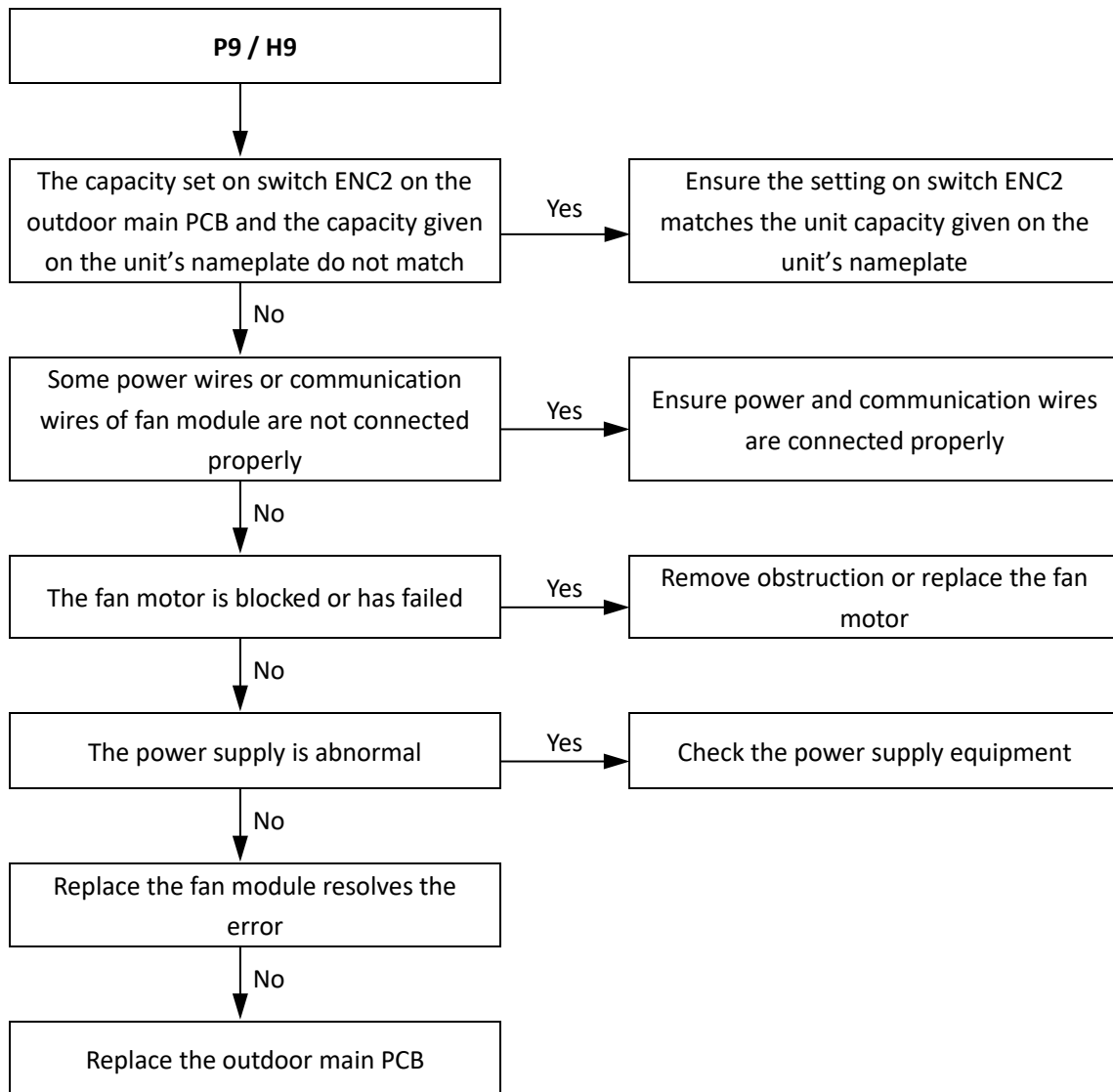

2.25 PL, C7: Inverter module temperature protection

2.25.1 Digital display output

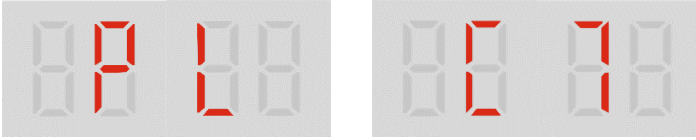

2.25.2 Description

- All units stop running.
- Error code is displayed on the unit with the error.

2.25.3 Trigger / recover condition

- Trigger condition:
For PL protection: Refer to Part 3 6.5 Inverter Module Temperature Protection Control
For C7 protection: PL protection appears three times in 100 minutes.
- Recover condition:
Refer to Part 3 6.5 Inverter Module Temperature Protection Control
- Reset method:
For PL protection: Resume automatically.
For C7 protection: Manually restart.

2.25.4 Possible causes

- Blocked, dirty or loose heat sink.
- Inverter module damaged.

2.25.5 Procedure

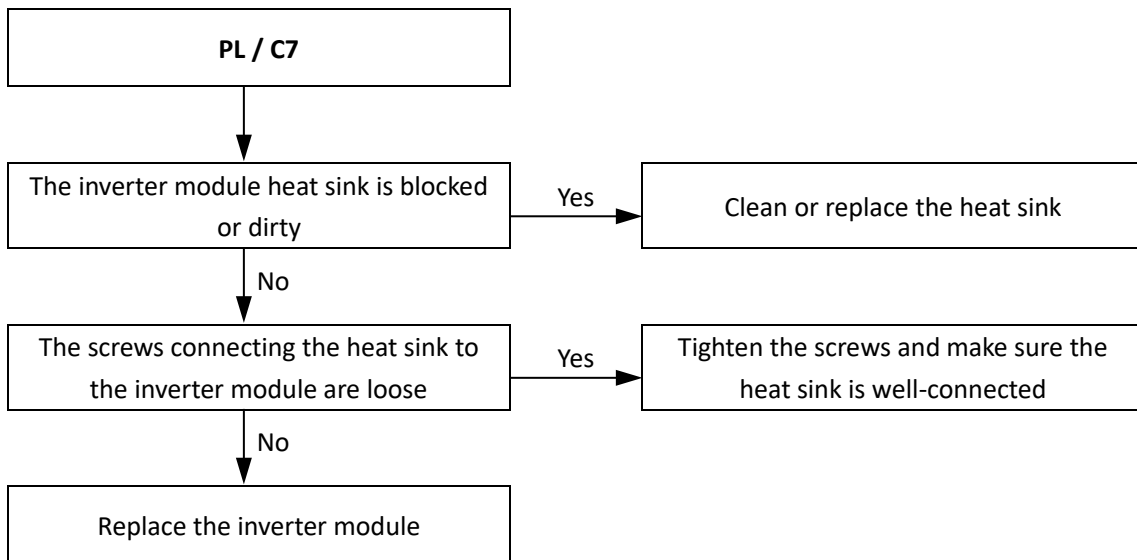

2.26 PP: Compressor discharge insufficient superheat protection

2.26.1 Digital display output

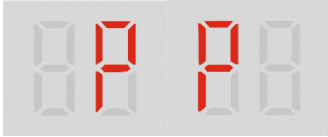

2.26.2 Description

- Compressor discharge insufficient superheat protection.
- All units stop running.
- Error code is displayed on the unit with the error.

2.26.3 Trigger / recover condition

- Trigger condition: Refer to Part 3 6.6 Wet Compression Protection Control.
- Recover condition: Refer to Part 3 6.6 Wet Compression Protection Control.
- Reset method: Resume automatically.

2.26.4 Possible causes

- Temperature sensor not connected properly or has malfunction.
- High pressure sensor not connected properly or has malfunction.
- Excess refrigerant.
- Some valves of ODU can't be fully closed.
- Some valves of IDU or MS can't be fully closed.
- Outdoor main PCB damaged.

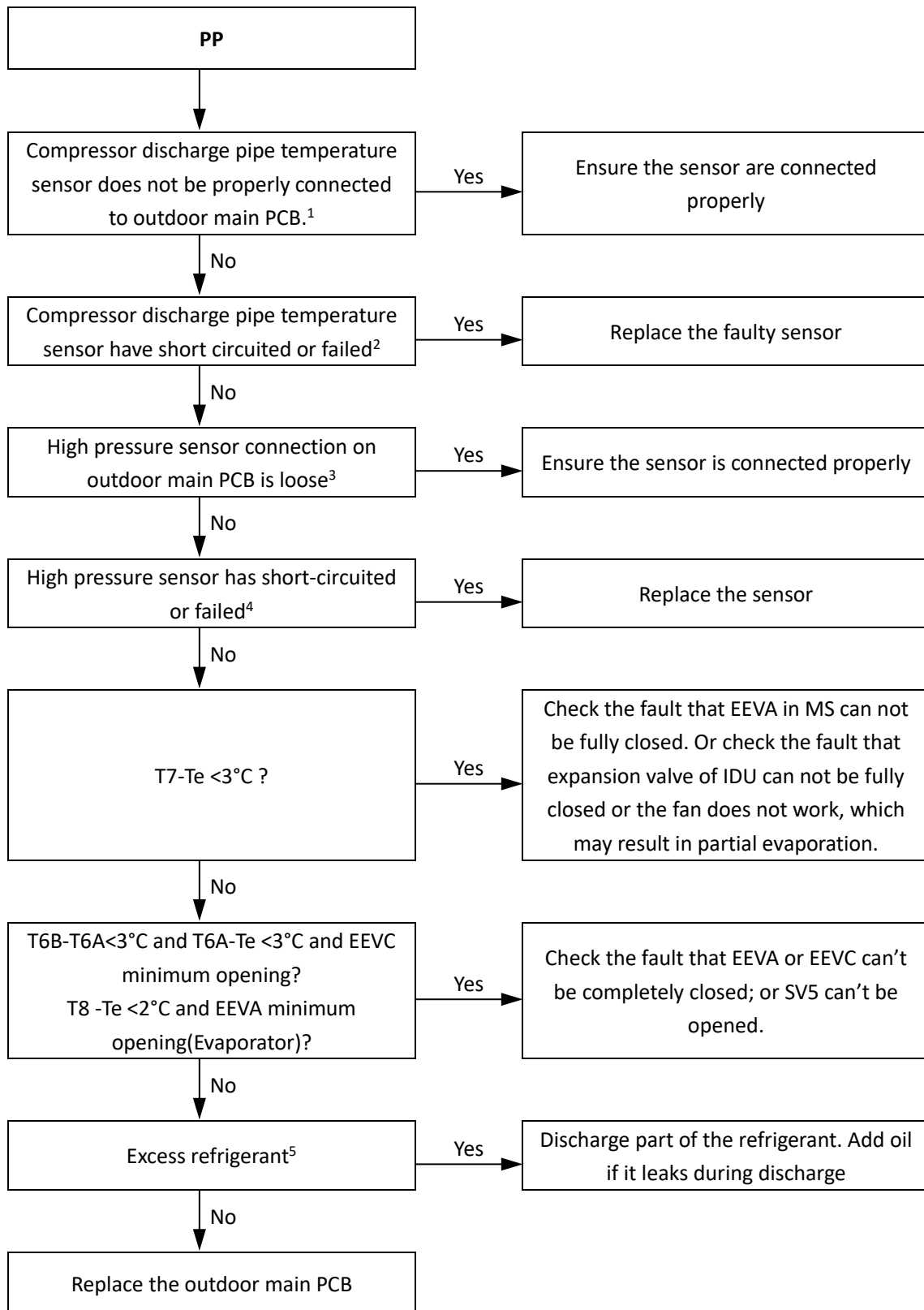
2.26.5 Procedure

Notes:

1. Compressor top temperature sensor and discharge pipe temperature sensor connections are ports CN4 on the outdoor main PCB.
2. Measure sensor resistance. If the resistance is too low, the sensor has short-circuited. If the resistance is not consistent with the sensor's resistance characteristics table, the sensor has failed.
3. High pressure sensor connection is port CN17 on the outdoor main PCB.
4. Measure the resistance among the three terminals of the pressure sensor. If the resistance is of the order of mega Ohms or infinite, the pressure sensor has failed.
5. Excess refrigerant causes discharge temperature to be lower than normal, discharge pressure to be higher than normal and suction pressure to be higher than normal.

2.27 A0: Emergency shutdown

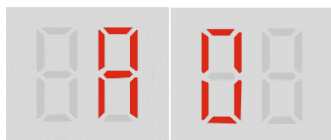
2.27.1 Digital display output



2.27.2 Description

- Compressor discharge insufficient superheat protection.
- All units stop running.
- Error code is only displayed on the master unit.

2.27.3 Trigger / recover condition

- Trigger condition:
The port of CN91 on the outdoor main PCB has short-circuited;
Received the emergency shutdown instructions from centralized controller.
- Recover condition:
The port of CN91 on the outdoor main PCB disconnects.
Cancel the emergency shutdown instructions from centralized controller.
- Reset method: Resume automatically.

2.27.4 Possible causes

- Outdoor main PCB damaged.
- Instructions of centralized controller

2.27.5 Procedure

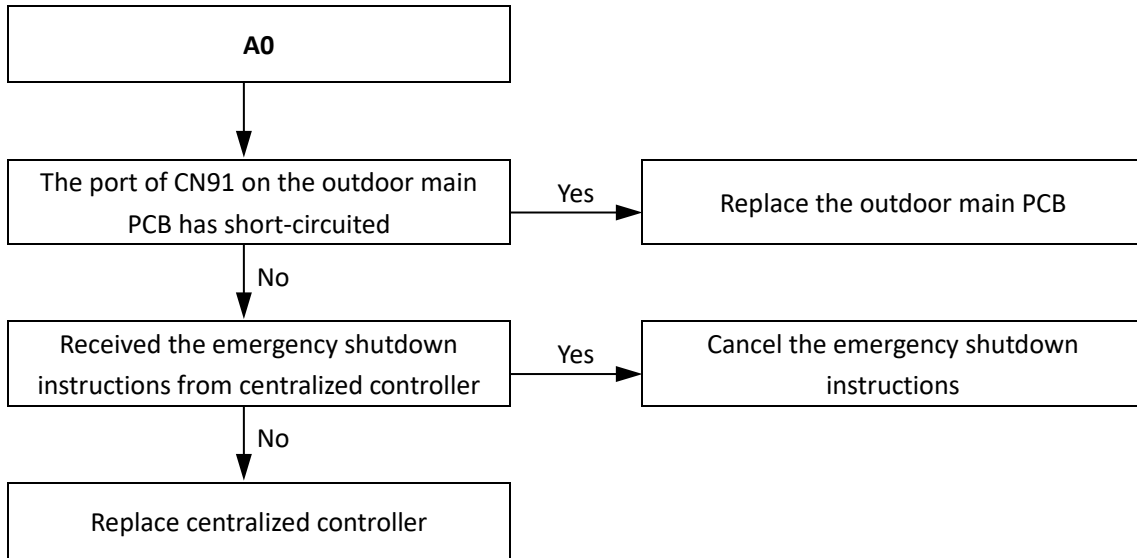

2.28 A1w: Refrigerant leakage protection

2.28.1 Digital display output

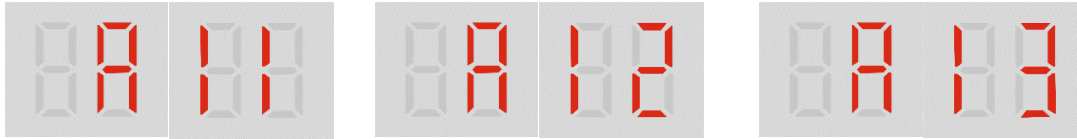

2.28.2 Description

- Refrigerant leakage protection.
- All units stop running.
- Error code is displayed on the unit with the error.

2.28.3 Trigger / recover condition

- Trigger condition:

If any MS reports refrigerant leak failure A1, the failure is sent to the ODU.

Menu Settings	Error Code	Description
nE=1	A11	The unit is stopped forcibly after the ODU reports A11.
nE=2	A12	The unit is stopped forcibly 12 hours after the ODU reports A12.
nE=3	A13	The unit is stopped forcibly 24 hours after the ODU reports A13.

- Recover condition:

The outdoor unit does not receive the refrigerant leakage fault signal sent by the MS.

- Reset method: Resume automatically.

2.28.4 Possible causes

- Refrigerant pipe or indoor unit leak.
- The refrigerant leak sensor is not connected or has malfunction.
- MS main control board is damaged.

2.28.5 Procedure

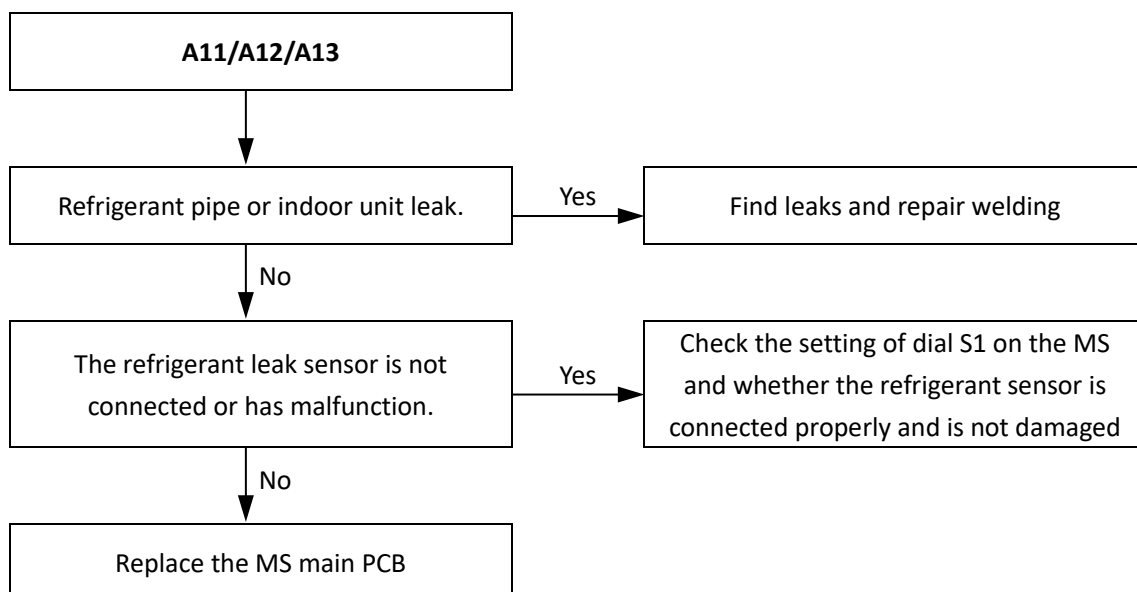

2.29 CA1, CA2, CA3, CA4, CA5: Connection combination error

2.29.1 Digital display output

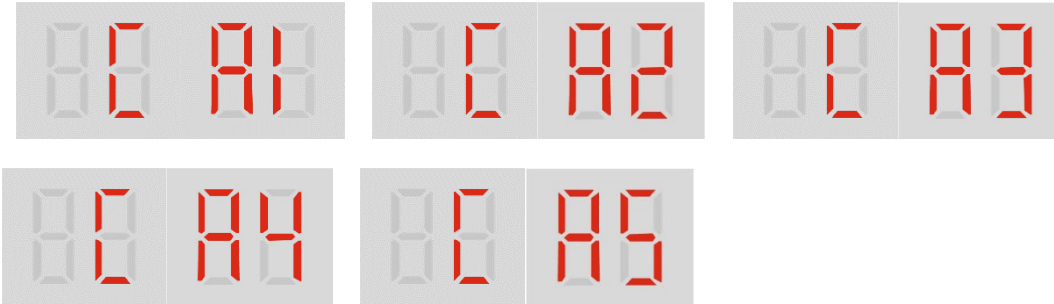

2.29.2 Description

- Connection combination error.
- All units stop running.
- Error code is only displayed on the master unit.

2.29.3 Trigger / recover condition

- Trigger condition:

The types of inside equipment that can be connected to the TVR ULTRA HR series heat recovery outdoor unit include:

- Standard air-cooled indoor unit (Fresh air indoor unit is treated as standard indoor unit)
- AHU KIT
- High temperature hydraulic module HT

The following connection combinations are allowed:

- TVR Indoor + AHU KIT
- TVR Indoor + HT
- TVR Indoor only

In addition to the above three cases, when the remaining connection combination is detected, the connection combination failure is reported.

CA1	The system contains non-TVRL ULTRA HR series compatible indoor units (the highest priority).
CA2	Only AHU KIT.
CA3	Only HT
CA4	Only HT + AHU KIT
CA5	TVR Indoor + AHU KIT + HT

- Recover condition:
Detected correct combination.
- Reset method: Manually restart.

2.29.4 Possible causes

- Combination does not meet the requirements.

2.29.5 Procedure

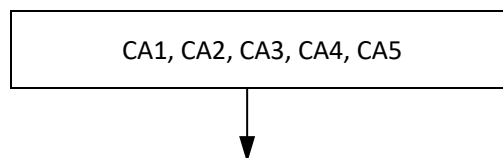

Change indoor unit combination

2.30 CB1, CB2, CB3, CB4: Overmatch protection

2.30.1 Digital display output

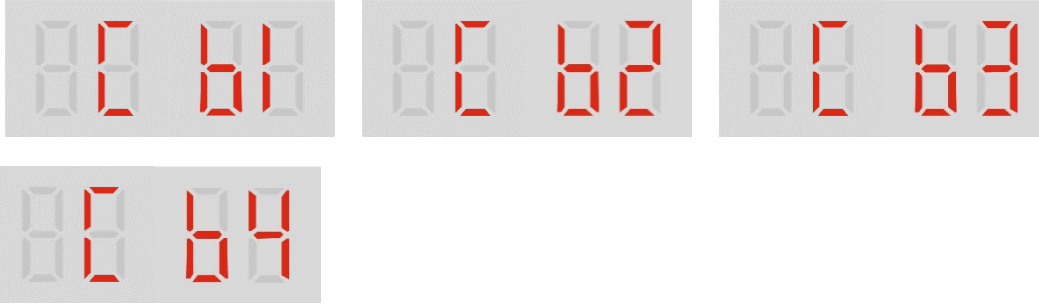

2.30.2 Description

- CB1: TVR indoor exceeds the match range (the highest priority)
- CB2: AHU kit exceeds the match range (second highest priority)
- CB3: HT exceeds the match range (third highest priority)
- CB4: The total connection ratio exceeds the match range (the fourth highest priority)
- All units stop running.
- Error code is only displayed on the master unit.

2.30.3 Trigger / recover condition

- Trigger condition: the indoor unit connection ratio exceeds the match table below.
- Recover condition: the indoor unit connection ratio in the range of the match table.
- Reset method: Manually restart.

Table 6-2.1: Match table

IDU1	IDU2	IDU3	Total connection ratio A(%)	IDU1 connection ratio B(%)	IDU2 connection ratio C(%)	IDU3 connection ratio D(%)	Note
TVR indoor	/	/	$40 \leq A \leq X^1$	$40 \leq B \leq X^1$	/	/	Connect at least one TVR Indoor
	HT	/	$40 \leq A \leq 205$	$40 \leq B \leq X^1$	$C \leq 105$	/	
	/	AHU kit	$40 \leq A \leq X^1$	$40 \leq B \leq X^1$	/	$C \leq 65$	
AHU kit	/	/	$40 \leq A \leq 115$	/	/	$D \leq 115$	

Notes:

1. X is 205 for single outdoor unit system; X is 155 for 2 outdoor units combination system; X is 135 for 3 outdoor units combination units system

2.30.4 Possible causes

- Connection ratio does not meet the requirements.

2.30.5 Procedure

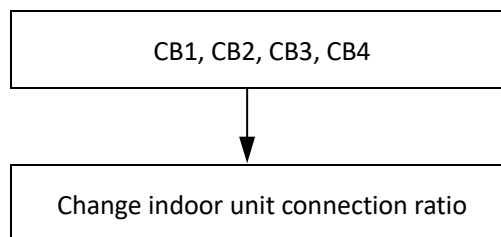

2.31 U0: Force cooling operation not performed

2.31.1 Digital display output



2.31.2 Description

- Forced cooling operation is set by switch S10 but it not performed in 30 minutes after power-on.
- All units stop running.
- Error code is only displayed on the master unit.

2.31.3 Trigger / recover condition

- Trigger condition:
Force cooling operation not performed in 30 minutes after power-on.
- Reset method: Manually restart.

2.31.4 Possible causes

- n11 was not selected for force cooling operation within 30 minutes after power on.

2.31.5 Procedure

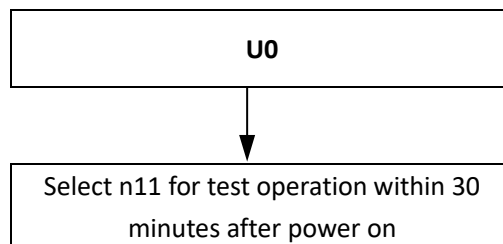

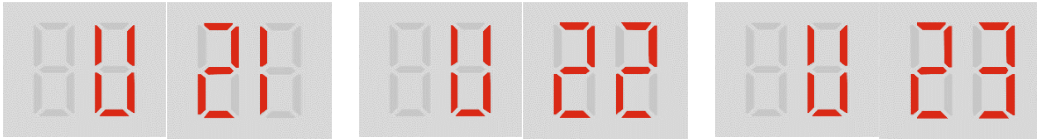
2.32 U21, U22, U23: Ambient temperature is out range of test operation.
2.32.1 Digital display output

2.32.2 Description

- Ambient temperature is out range of test operation.
- All units stop running.
- Error code is only displayed on the master unit.

2.32.3 Trigger / recover condition

- Trigger condition:

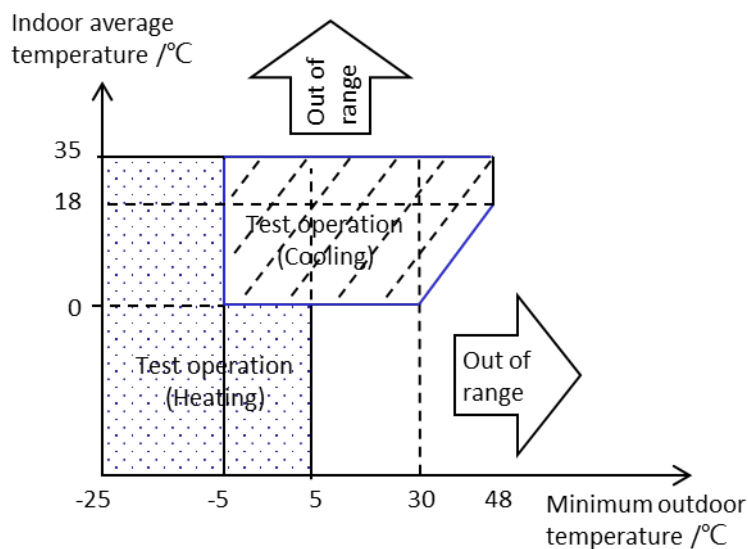
After entering the test operation, the master outdoor unit judges whether it is suitable for the trial operation based on the average value of the detected T1 and the outdoor ambient temperature T4. If it is not in the unsuitable zone, make the cooling self-test and heating self-check selection according to the following table.



If it is out range of test operation, the outdoor unit displays the fault code "U21 or U22 or U23".

Item	Conditions	Code
Not suitable for outdoor temperature	Minimum outdoor temperature $\leq -24.5^{\circ}\text{C}$ or Minimum outdoor temperature $\geq 48^{\circ}\text{C}$	U21
Not suitable for indoor temperature	Indoor average temperature $\geq 35^{\circ}\text{C}$	U22
Not suitable for outdoor temperature and indoor temperature	1. Indoor average temperature $< 0^{\circ}\text{C}$, Minimum outdoor temperature $\geq 5^{\circ}\text{C}$ 2. Indoor average temperature $\geq 0^{\circ}\text{C}$ and Minimum outdoor temperature - Indoor average temperature $\geq 30^{\circ}\text{C}$	U23

- Recover condition:
Press the OK key for 5 seconds to exit the test operation.
- Reset method: Manually restart.

2.32.4 Possible causes

- Temperature is out of range.

2.32.5 Procedure

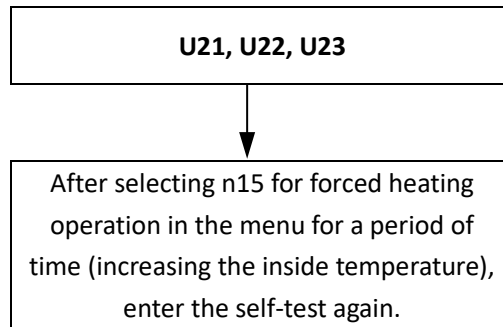

2.33 U31, U32, U33: Stop valve is not open.

2.33.1 Digital display output

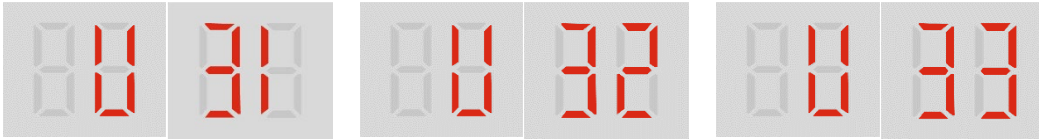

2.33.2 Description

- U31: Liquid side stop valve is not opened.
- U32: High pressure gas side stop valve is not opened.
- U33: Low pressure gas side stop valve is not opened.
- All units stop running.
- Error code is only displayed on the master unit.

2.33.3 Trigger / recover condition

- Trigger condition:
 - U31: $P_{c_max} \geq 3.9\text{MPa}$ in heating operation.
 - U32: $P_{c_max} \geq 3.9\text{MPa}$ in heating operation.
 - U33: $P_{e_min} < 0.12\text{MPa}$ in cooling operation.
- Recover condition:
 - The stop valves are opened and system pressure recover to normal.
- Reset method: Manually restart.

2.33.4 Possible causes

- Stop valve is not open.

2.33.5 Procedure

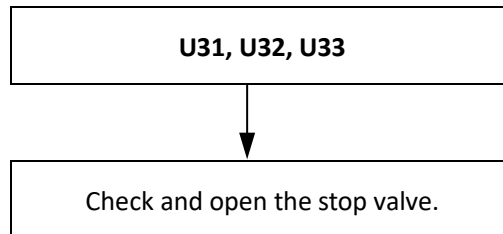

2.34 U4: Indoor unit refrigerant pipe and signal cable connection are inconsistent

2.34.1 Digital display output

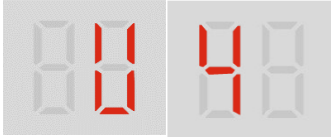

2.34.2 Description

- Indoor unit refrigerant pipe and signal cable connection are inconsistent.
- All units stop running.
- Error code is only displayed on the master unit.

2.34.3 Trigger / recover condition

- Trigger condition:
Indoor unit refrigerant pipe and signal cable connection are inconsistent.
- Recover condition:
Indoor unit refrigerant pipe and signal cable connection are consistent.
- Reset method: Manually restart.

2.34.4 Possible causes

- Indoor unit refrigerant pipe and signal cable connection are inconsistent.

2.34.5 Procedure

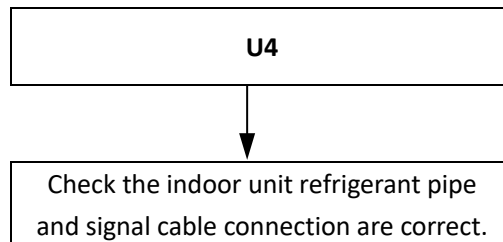

3 Troubleshooting for Mode Selection Box

3.1 Warning

Warning

- All electrical work must be carried out by competent and suitably qualified, certified and accredited professionals and in accordance with all applicable legislation (all national, local and other laws, standards, codes, rules, regulations and other legislation that apply in a given situation).
- Power-off the MS unit before connecting or disconnecting any connections or wiring, otherwise electric shock (which can cause physical injury or death) may occur or damage to components may occur.

3.2 E2: Communication error between MS and master outdoor unit

3.2.1 Digital display output

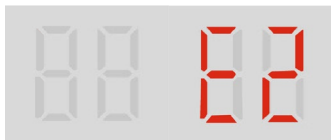

3.2.2 Description

- Communication failure between MS and master outdoor unit.
- All units stop running.
- Error code is displayed on the malfunction MS box.
- The indoor unit display board or wired controller connected to this MS displays "F8".

3.2.3 Trigger / recover condition

- Trigger condition: MS and master outdoor units cannot communication for 1 minutes after the system power on.
- Recover condition: Communication go back to normal.
- Reset method: Resume automatically.

3.2.4 Possible causes

- Communication wires between MS and outdoor units not connected properly.
- Loosened wiring within electric control box.
- The sequence of the PQE signal lines is incorrect.
- Interference from high voltage wires or other sources of electromagnetic radiation.
- Communication wire too long.
- Damaged outdoor or MS PCB or electric control box communication terminals block.

3.2.5 Procedure

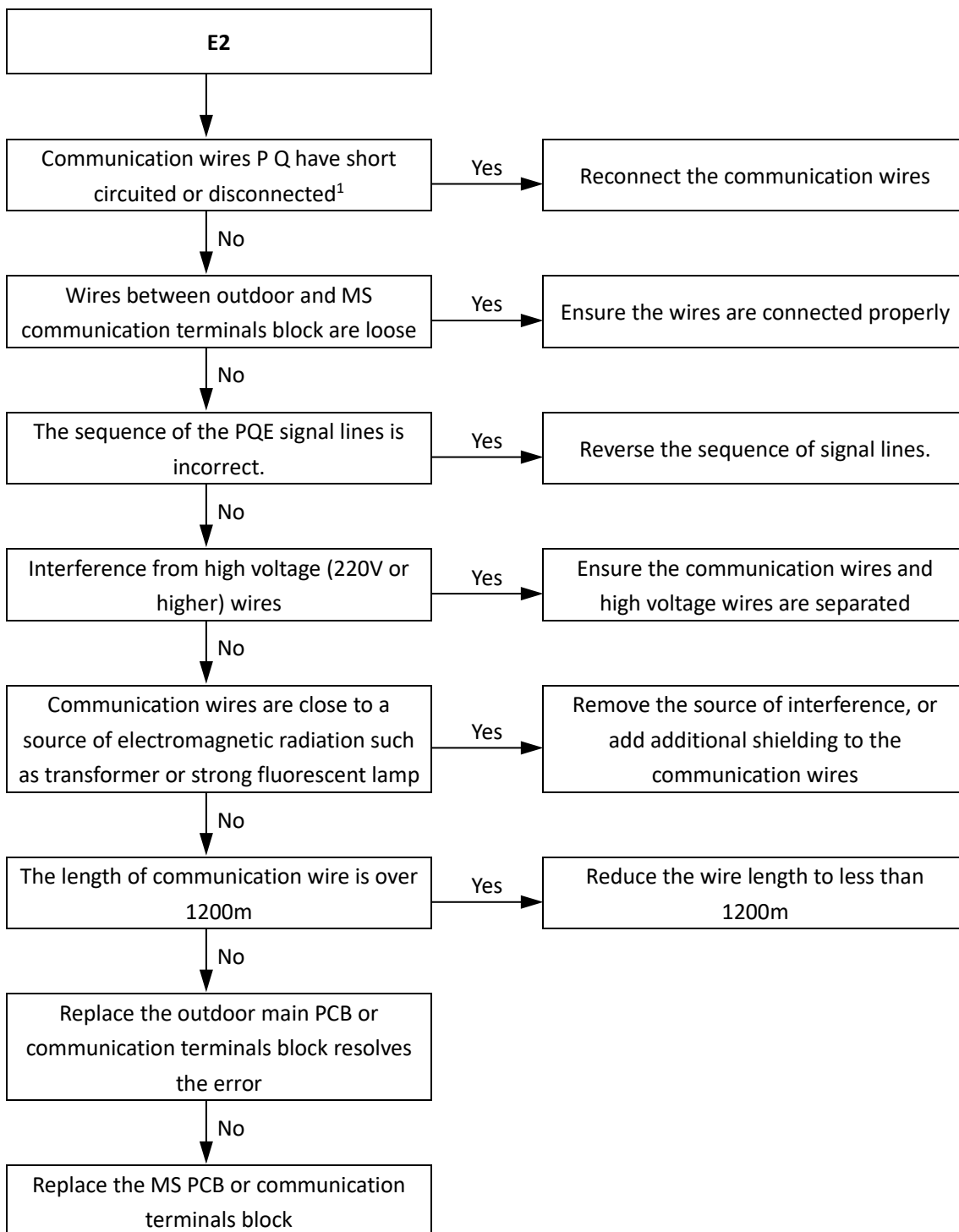

Notes:

1. Measure the resistance among P, Q and E. The normal resistance between P and Q is 120Ω, between P and E is infinite, between Q and E is infinite.

3.3 E3/E4: T1C1/T2C2 Temperature sensor error

3.3.1 Digital display output

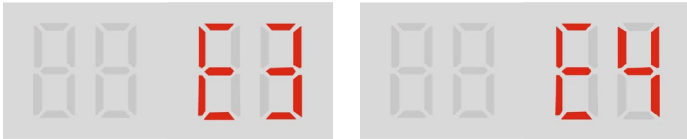

3.3.2 Description

- E3 indicates malfunction of subcooler outlet temperature sensor (T1C1).
- E4 indicates malfunction of subcooler outlet temperature sensor (T2C2).
- All units stop running.
- Error code is displayed on the malfunction MS box.
- The indoor unit display board or wired controller connected to this MS displays "F8".

3.3.3 Trigger / recover condition

- Trigger condition: The main control board cannot receive the feedback signal of temperature sensor T1C1 or T2C2.
- Recover condition: The main control board can receive the feedback signal of temperature sensor T1C1 or T2C2.
- Reset method: Resume automatically.

3.3.4 Possible causes

- Temperature sensor not connected properly or has malfunction.
- MS main PCB is damaged.

3.3.5 Procedure

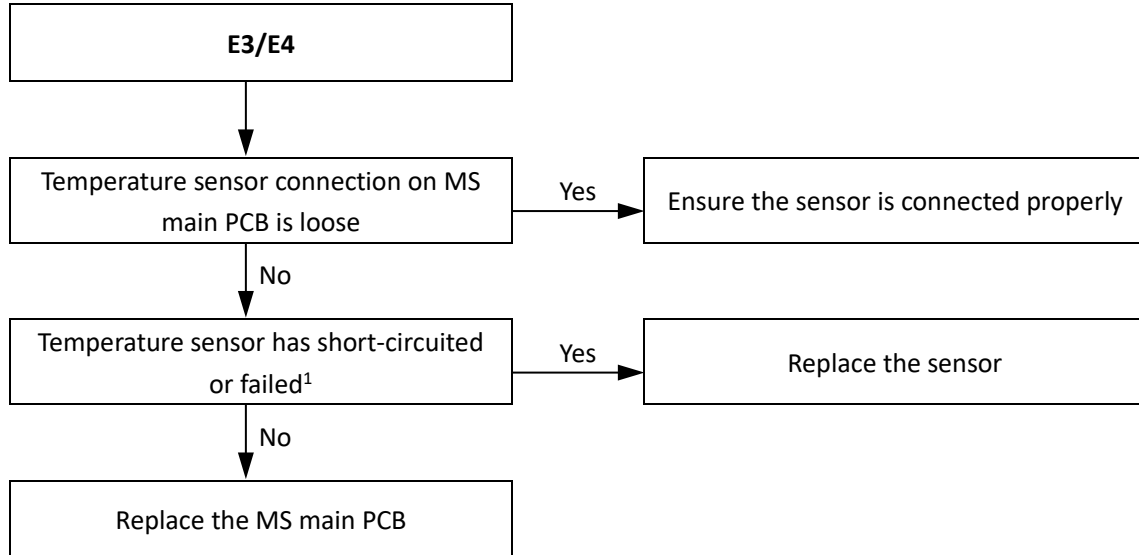

Notes:

1. Measure sensor resistance. If the resistance is too low, the sensor has short-circuited. If the resistance is not consistent with the sensor's resistance characteristics table, the sensor has failed. Refer to Table 6-4.1 in Part 6, 4.1 "Temperature Sensor Resistance Characteristics".

3.4 E7: EEPROM error

3.4.1 Digital display output



3.4.2 Description

- EEPROM error.
- All units stop running.
- Error code is displayed on the malfunction MS box.
- The indoor unit display board or wired controller connected to this MS displays "F8".

3.4.3 Trigger / recover condition

- Trigger condition: MS EEPROM parameter is mismatch.
- Recover condition: Cannot recover.
- Reset method: Manually restart.

3.4.4 Possible causes

- MS PCB damaged.

3.4.5 Procedure

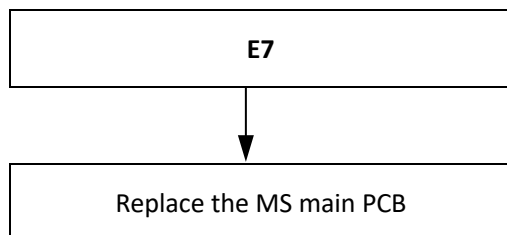

3.5 FE: MS has no address when first powered on

3.5.1 Digital display output



3.5.2 Description

- MS has no address when first powered on.
- All units stop running.
- Error code is displayed on the malfunction MS box.
- The indoor unit display board or wire control connected to this MS displays "F8".

3.5.3 Trigger / recover condition

- Trigger condition: MS has no address when first powered on.
- Recover condition: MS has got an address.
- Reset method: Resume automatically.

3.5.4 Possible causes

- The outdoor unit is not powered on or the address assignment is unsuccessful.

3.5.5 Procedure

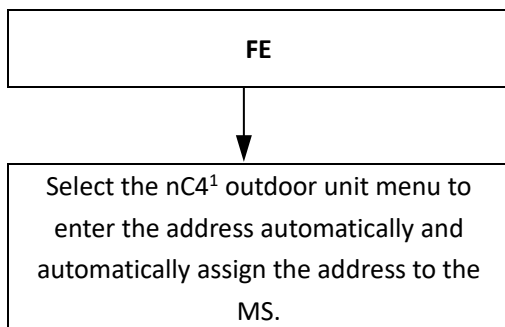

Notes:

1. Refer to Part 5, 2.2.3 "Menu mode"

3.6 LL: S1+S2 dialing setting error (for MS04-12)

3.6.1 Digital display output

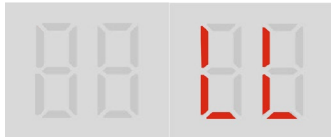

3.6.2 Description

- S1+S2 dialing setting error.
- All units stop running.
- Error code is displayed on the malfunction MS box.
- The indoor unit display board or wired controller connected to this MS displays "F8".

3.6.3 Trigger / recover condition

- Trigger condition: S1 and S2 are set to ON, but the indoor unit is connected to both pipes 1 and 2 (or the indoor unit is connected to pipes 3 and 4).
- Recover condition: Does not meet trigger conditions.
- Reset method: Manually restart.

3.6.4 Possible causes

- S1+S2 dialing setting error.
- Signal cables are incorrectly connected.
- MS PCB damaged.

3.6.5 Procedure

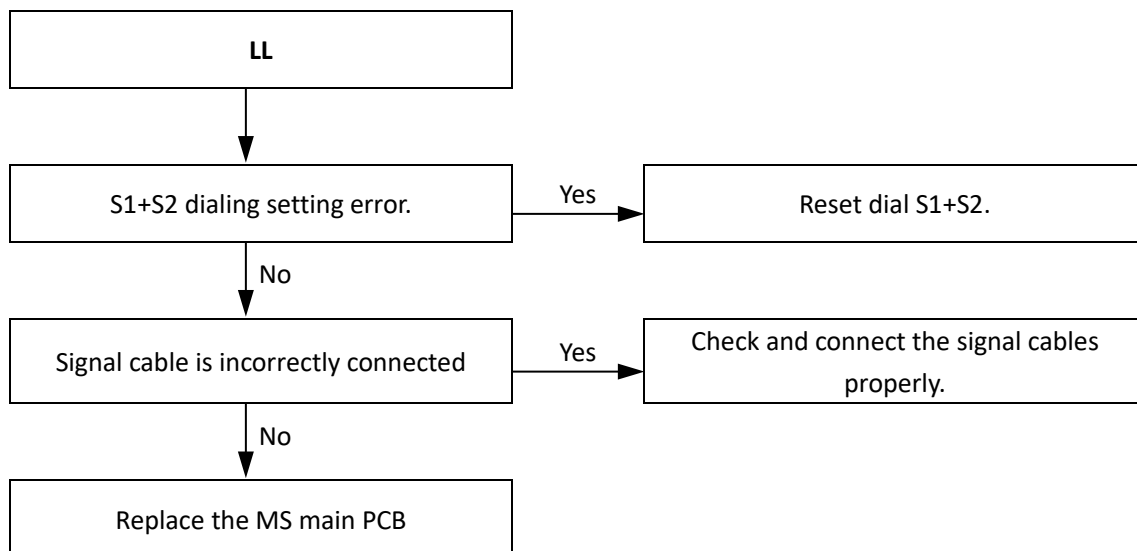

3.7 H0: Communication between master and slave control boards failed (for MS04-12)

3.7.1 Digital display output



3.7.2 Description

- H0 indicates a communication error between master and slave MS PCB.
- All units stop running.
- Error code is displayed on the malfunction MS box.

3.7.3 Trigger / recover condition

- Trigger condition: the communication between MS's master PCB board and slave PCB is abnormal for 2 minutes.
- Recover condition: Communication go back to normal.
- Reset method: Resume automatically.

3.7.4 Possible causes

- Loosened communication wiring from the master PCB to the slave PCBs.
- MS PCB damaged.
- Slave MS has power off.

3.7.5 Procedure

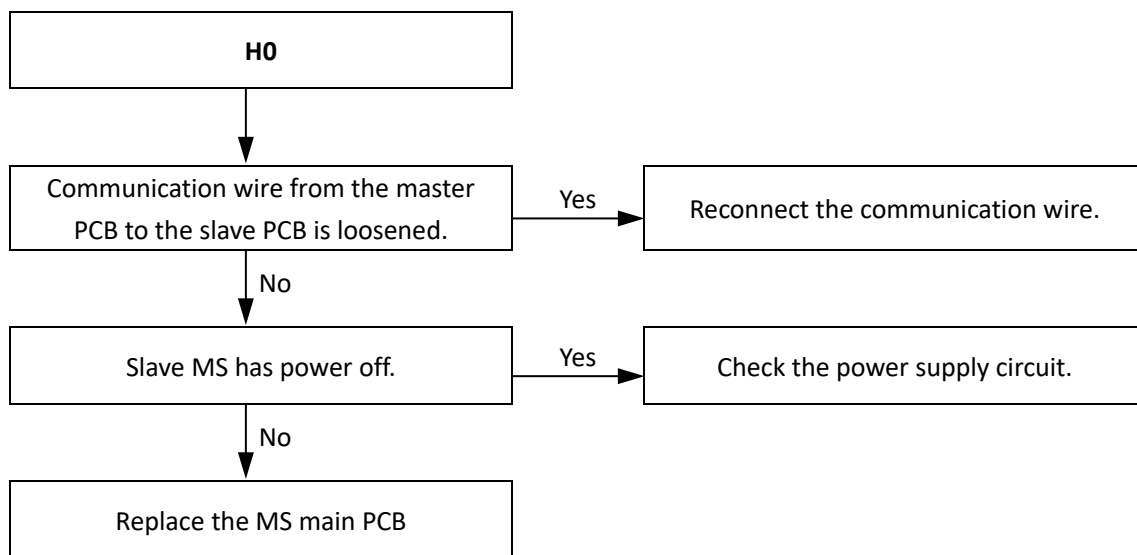

3.8 F6: Electronic ball valve connection failure (for MS01)

3.8.1 Digital display output



3.8.2 Description

- Electronic ball valve (EBVA/EBVB/EBVC) connection failure.
- All units stop running.
- Error code is displayed on the unit with the error. The indoor unit display board or wired controller connected under this MS displays "F8" fault code.

3.8.3 Trigger / recover condition

- Trigger condition: The main control board cannot receive the feedback signal of EBV.
- Recover condition: The main control board can receive the feedback signal of EBV.
- Reset method: Manually restart.

3.8.4 Possible causes

- Electronic ball valve coil doesn't connect properly or malfunction.
- MS PCB damaged.

3.8.5 Procedure

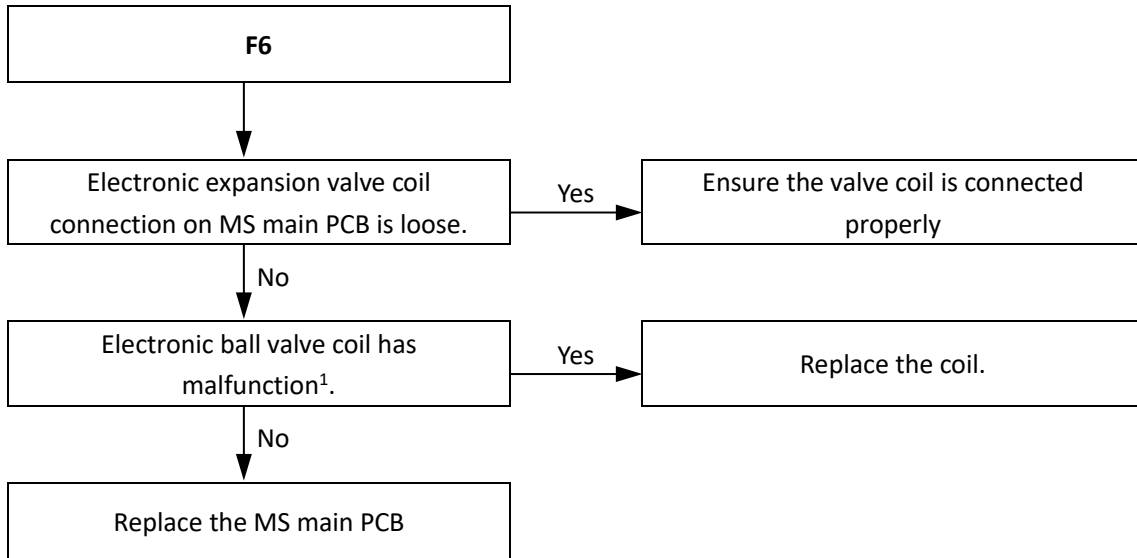

Notes:

1. The normal resistances between EBV coil wiring terminals Gray (common port) and Blake / Yellow / Red / Orange are 40-50Ω. If any of the resistances differ from the value, the EBV coil has malfunction.

Figure 6-2.4: EBV coil wiring terminals

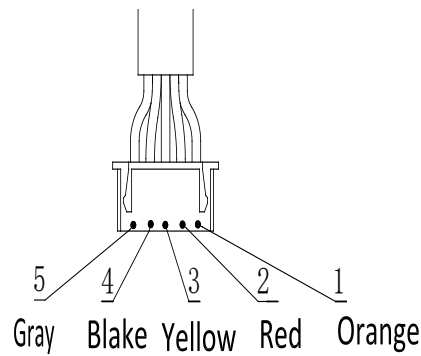

3.9 F7: Main power off (for MS01)

3.9.1 Digital display output



3.9.2 Description

- Main power off.
- All units stop running.
- Error code is displayed on the malfunction MS box.
- The indoor unit display board or wired controller connected to this MS displays "F8".

3.9.3 Trigger / recover condition

- Trigger condition: MS main power off, and UPS power is ON.
- Recover condition: MS main power on, and UPS power is OFF.
- Reset method: Resume automatically.

3.9.4 Possible causes

- Abnormal power supply.
- The power supply wiring is loose.
- MS PCB damaged.

3.9.5 Procedure

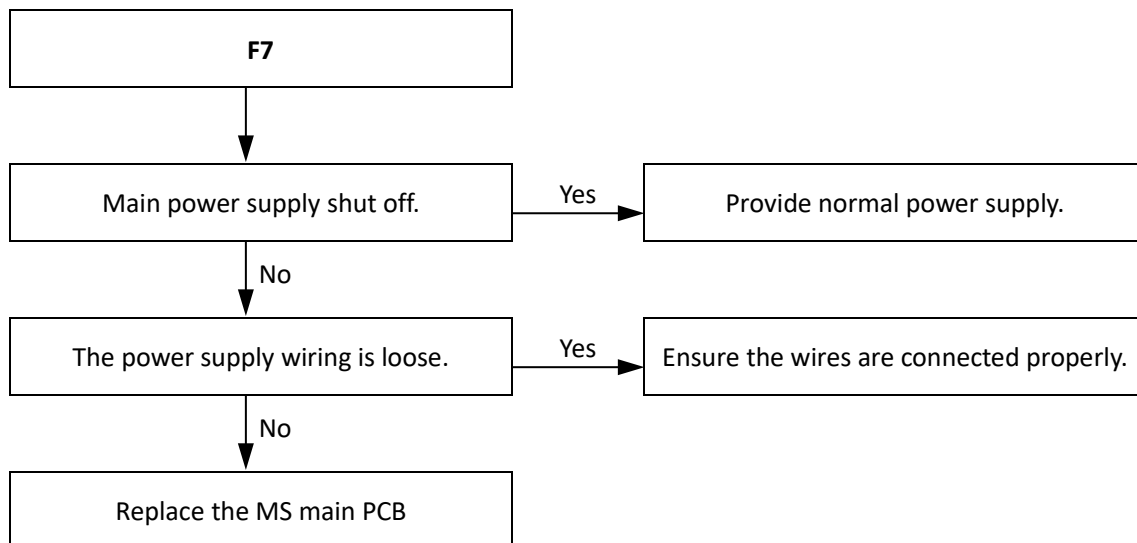

3.10 F9: Overload error (for MS01)

3.10.1 Digital display output



3.10.2 Description

- Overload error.
- All units stop running.
- Error code is displayed on the malfunction MS box.
- The indoor unit display board or wired controller connected to this MS displays "F8".

3.10.3 Trigger / recover condition

- Trigger condition: Total capacity of indoor units connected to the MS01 is more than 12HP.
- Recover condition: Total capacity of indoor units connected to the MS01 is less than 12HP.
- Reset method: Manually restart.

3.10.4 Possible causes

- The indoor unit is out range of connection permission.
- the signal cable is connected incorrectly.

3.10.5 Procedure

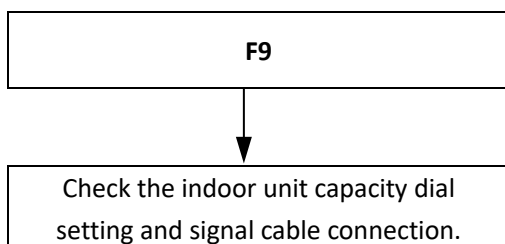

3.11 A1: Refrigerant leakage protection (for MS01)

3.11.1 Digital display output

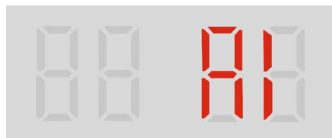

3.11.2 Description

- Refrigerant leakage protection.
- All units stop running.
- Error code is displayed on the malfunction MS box.

3.11.3 Trigger / recover condition

- Trigger condition: Communication between main control board and inverter driver board is abnormal for 2 minutes.
- Recover condition: Communication go back to normal.
- Reset method: Resume automatically.

3.11.4 Possible causes

- S1 dial setting error.
- Refrigerant leak.
- Refrigerant leak sensor failure.
- MS PCB damaged.

3.11.5 Procedure

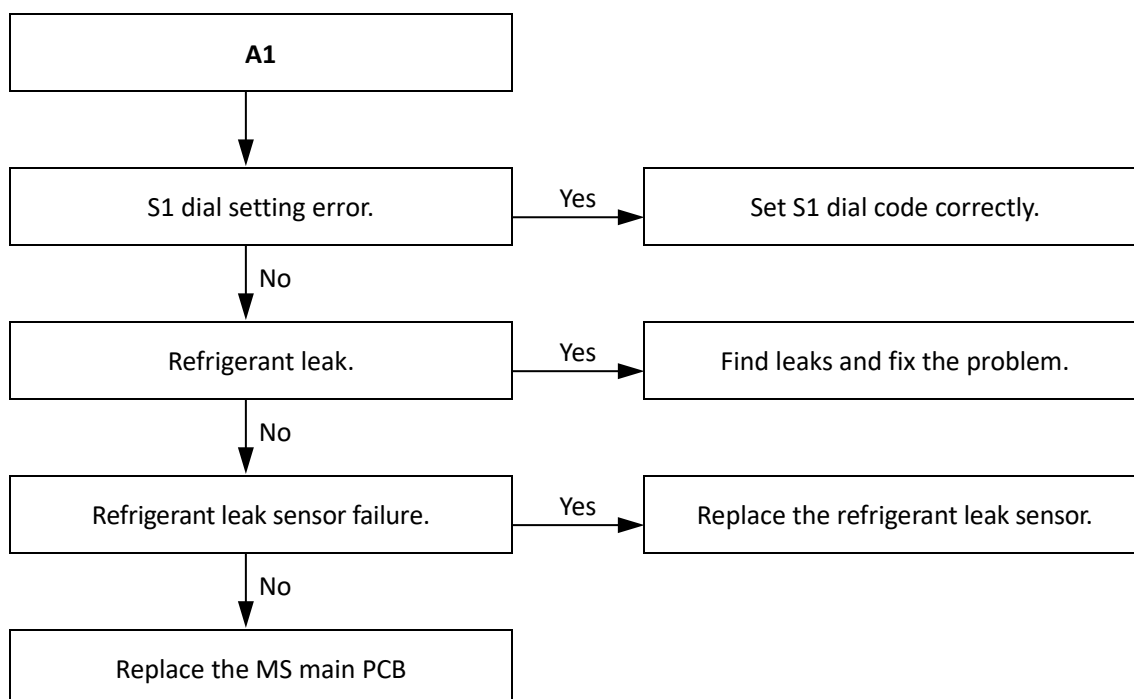

4 Appendix to Part 6

4.1 Temperature Sensor Resistance Characteristics

Table 6-4.1: Temperature sensor resistance characteristics

Temp. (°C)	Temp. (°F)	Resistance (KΩ)	Voltage (V)	Temp. (°C)	Temp. (°F)	Resistance (KΩ)	Voltage (V)	Temp. (°C)	Temp. (°F)	Resistance (KΩ)	Voltage (V)
-39	-38.2	387.13	0.1020	11	51.8	19.617	1.4561	61	141.8	2.2728	3.9002
-38	-36.4	360.98	0.1092	12	53.6	18.656	1.5085	62	143.6	2.1912	3.9312
-37	-34.6	336.73	0.1169	13	55.4	17.749	1.5615	63	145.4	2.113	3.9615
-36	-32.8	314.24	0.1250	14	57.2	16.891	1.6152	64	147.2	2.0381	3.9908
-35	-31	293.38	0.1337	15	59	16.08	1.6694	65	149	1.9662	4.0195
-34	-29.2	274.01	0.1429	16	60.8	15.313	1.7242	66	150.8	1.8973	4.0473
-33	-27.4	256.05	0.1526	17	62.6	14.587	1.7795	67	152.6	1.8312	4.0743
-32	-25.6	239.36	0.1629	18	64.4	13.899	1.8352	68	154.4	1.7678	4.1006
-31	-23.8	223.87	0.1738	19	66.2	13.249	1.8912	69	156.2	1.707	4.1261
-30	-22	209.48	0.1853	20	68	12.632	1.9476	70	158	1.6486	4.1510
-29	-20.2	196.11	0.1974	21	69.8	12.048	2.0042	71	159.8	1.5925	4.1751
-28	-18.4	183.68	0.2102	22	71.6	11.495	2.0609	72	161.6	1.5387	4.1985
-27	-16.6	172.12	0.2237	23	73.4	10.97	2.1177	73	163.4	1.487	4.2212
-26	-14.8	161.36	0.2379	24	75.2	10.472	2.1746	74	165.2	1.4373	4.2433
-25	-13	151.344	0.2528	25	77	10	2.2315	75	167	1.3896	4.2647
-24	-11.2	142.02	0.2685	26	78.8	9.5519	2.2882	76	168.8	1.3437	4.2855
-23	-9.4	133.32	0.2850	27	80.6	9.1265	2.3449	77	170.6	1.2996	4.3057
-22	-7.6	125.22	0.3024	28	82.4	8.7226	2.4013	78	172.4	1.2572	4.3253
-21	-5.8	117.66	0.3206	29	84.2	8.3389	2.4575	79	174.2	1.2164	4.3444
-20	-4	110.6	0.3396	30	86	7.9743	2.5134	80	176	1.1772	4.3628
-19	-2.2	104.02	0.3596	31	87.8	7.6279	2.5689	81	177.8	1.1394	4.3807
-18	-0.4	97.861	0.3805	32	89.6	7.2985	2.6240	82	179.6	1.103	4.3981
-17	1.4	92.107	0.4023	33	91.4	6.9853	2.6786	83	181.4	1.0681	4.4149
-16	3.2	86.727	0.4252	34	93.2	6.6873	2.7327	84	183.2	1.0344	4.4313
-15	5	81.694	0.4490	35	95	6.4038	2.7863	85	185	1.0019	4.4472
-14	6.8	76.982	0.4739	36	96.8	6.134	2.8392	86	186.8	0.9707	4.4626
-13	8.6	72.57	0.4998	37	98.6	5.8772	2.8915	87	188.6	0.94059	4.4775
-12	10.4	68.437	0.5268	38	100.4	5.6326	2.9432	88	190.4	0.91158	4.4920
-11	12.2	64.564	0.5549	39	102.2	5.3996	2.9941	89	192.2	0.88362	4.5060
-10	14	60.932	0.5841	40	104	5.1776	3.0444	90	194	0.85667	4.5196
-9	15.8	57.526	0.6145	41	105.8	4.966	3.0938	91	195.8	0.83068	4.5328
-8	17.6	54.33	0.6459	42	107.6	4.7644	3.1424	92	197.6	0.80561	4.5457
-7	19.4	51.331	0.6786	43	109.4	4.5721	3.1903	93	199.4	0.78143	4.5581
-6	21.2	48.514	0.7123	44	111.2	4.3887	3.2373	94	201.2	0.75811	4.5701
-5	23	45.869	0.7473	45	113	4.2137	3.2834	95	203	0.7356	4.5818
-4	24.8	43.383	0.7834	46	114.8	4.0468	3.3287	96	204.8	0.71387	4.5932
-3	26.6	41.047	0.8207	47	116.6	3.8874	3.3731	97	206.6	0.6929	4.6042
-2	28.4	38.85	0.8591	48	118.4	3.7353	3.4166	98	208.4	0.67266	4.6149
-1	30.2	36.784	0.8987	49	120.2	3.59	3.4592	99	210.2	0.6531	4.6252
0	32	34.84	0.9394	50	122	3.4512	3.5009	100	212	0.63422	4.6353
1	33.8	33.011	0.9812	51	123.8	3.3186	3.5417	101	213.8	0.61598	4.6450
2	35.6	31.288	1.0242	52	125.6	3.1919	3.5816	102	215.6	0.59836	4.6545
3	37.4	29.666	1.0682	53	127.4	3.0708	3.6206	103	217.4	0.58133	4.6636
4	39.2	28.137	1.1134	54	129.2	2.955	3.6586	104	219.2	0.56487	4.6725
5	41	26.697	1.1595	55	131	2.8442	3.6958	105	221	0.54896	4.6812
6	42.8	25.339	1.2066	56	132.8	2.7382	3.7321				
7	44.6	24.058	1.2547	57	134.6	2.6369	3.7674				
8	46.4	22.85	1.3038	58	136.4	2.5398	3.8020				
9	48.2	21.71	1.3537	59	138.2	2.4469	3.8356				
10	50	20.633	1.4045	60	140	2.358	3.8683				

Notes:

- Table 6-4.1 is suitable for the following sensors:
 Outdoor unit: T3, T4, T5, T6A, T6B, T7, T8, T9, TL
 MS: T1C1, T2C2
 Indoor unit: T1, T2, T2A, T2B
- The Resistance of 25C (77F) is 10 KΩ±1%. The relation between voltage and resistance is: $V = \frac{8.06}{8.06+R} * 5$

TVR Ultra HR 50/60Hz



Table 6-4.2: Compressor discharge pipe temperature sensor (T1C1) resistance characteristics

Temp. (°C)	Temp. (°F)	Resistance (KΩ)	Voltage (V)	Temp. (°C)	Temp. (°F)	Resistance (KΩ)	Voltage (V)	Temp. (°C)	Temp. (°F)	Resistance (KΩ)	Voltage (V)
-20	-4	542.7	0.0732	32	89.6	40.57	0.8287	84	183.2	6.033	2.8596
-19	-2.2	511.9	0.0775	33	91.4	38.89	0.8584	85	185	5.844	2.8984
-18	-0.4	483	0.0821	34	93.2	37.3	0.8884	86	186.8	5.663	2.9367
-17	1.4	455.9	0.0869	35	95	35.78	0.9193	87	188.6	5.488	2.9746
-16	3.2	430.5	0.0919	36	96.8	34.32	0.9509	88	190.4	5.32	3.0120
-15	5	406.7	0.0972	37	98.6	32.94	0.9829	89	192.2	5.157	3.0491
-14	6.8	384.3	0.1027	38	100.4	31.62	1.0156	90	194	5	3.0858
-13	8.6	363.3	0.1085	39	102.2	30.36	1.0489	91	195.8	4.849	3.1219
-12	10.4	343.6	0.1146	40	104	29.15	1.0830	92	197.6	4.703	3.1576
-11	12.2	325.1	0.1210	41	105.8	28	1.1176	93	199.4	4.562	3.1928
-10	14	307.7	0.1276	42	107.6	26.9	1.1527	94	201.2	4.426	3.2276
-9	15.8	291.3	0.1346	43	109.4	25.86	1.1881	95	203	4.294	3.2621
-8	17.6	275.9	0.1419	44	111.2	24.85	1.2246	96	204.8	4.167	3.2960
-7	19.4	261.4	0.1496	45	113	23.89	1.2613	97	206.6	4.045	3.3292
-6	21.2	247.8	0.1575	46	114.8	22.89	1.3021	98	208.4	3.927	3.3620
-5	23	234.9	0.1659	47	116.6	22.1	1.3362	99	210.2	3.812	3.3945
-4	24.8	222.8	0.1746	48	118.4	21.26	1.3745	100	212	3.702	3.4263
-3	26.6	211.4	0.1836	49	120.2	20.46	1.4130	101	213.8	3.595	3.4577
-2	28.4	200.7	0.1930	50	122	19.69	1.4523	102	215.6	3.492	3.4886
-1	30.2	190.5	0.2030	51	123.8	18.96	1.4915	103	217.4	3.392	3.5190
0	32	180.9	0.2133	52	125.6	18.26	1.5312	104	219.2	3.296	3.5488
1	33.8	171.9	0.2239	53	127.4	17.58	1.5718	105	221	3.203	3.5781
2	35.6	163.3	0.2352	54	129.2	16.94	1.6120	106	222.8	3.113	3.6069
3	37.4	155.2	0.2468	55	131	16.32	1.6530	107	224.6	3.025	3.6355
4	39.2	147.6	0.2589	56	132.8	15.73	1.6940	108	226.4	2.941	3.6633
5	41	140.4	0.2715	57	134.6	15.16	1.7356	109	228.2	2.86	3.6905
6	42.8	133.5	0.2847	58	136.4	14.62	1.7769	110	230	2.781	3.7174
7	44.6	127.1	0.2982	59	138.2	14.09	1.8194	111	231.8	2.704	3.7440
8	46.4	121	0.3123	60	140	13.59	1.8614	112	233.6	2.63	3.7699
9	48.2	115.2	0.3270	61	141.8	13.11	1.9036	113	235.4	2.559	3.7951
10	50	109.8	0.3419	62	143.6	12.65	1.9459	114	237.2	2.489	3.8203
11	51.8	104.6	0.3577	63	145.4	12.21	1.9882	115	239	2.422	3.8447
12	53.6	99.69	0.3740	64	147.2	11.79	2.0302	116	240.8	2.357	3.8687
13	55.4	95.05	0.3908	65	149	11.38	2.0730	117	242.6	2.294	3.8922
14	57.2	90.66	0.4082	66	150.8	10.99	2.1155	118	244.4	2.233	3.9153
15	59	86.49	0.4262	67	152.6	10.61	2.1585	119	246.2	2.174	3.9379
16	60.8	82.54	0.4448	68	154.4	10.25	2.2010	120	248	2.117	3.9599
17	62.6	78.79	0.4640	69	156.2	9.902	2.2436	121	249.8	2.061	3.9818
18	64.4	75.24	0.4838	70	158	9.569	2.2860	122	251.6	2.007	4.0032
19	66.2	71.86	0.5043	71	159.8	9.248	2.3284	123	253.4	1.955	4.0240
20	68	68.66	0.5253	72	161.6	8.94	2.3706	124	255.2	1.905	4.0442
21	69.8	65.62	0.5470	73	163.4	8.643	2.4127	125	257	1.856	4.0641
22	71.6	62.73	0.5693	74	165.2	8.358	2.4546	126	258.8	1.808	4.0839
23	73.4	59.98	0.5923	75	167	8.084	2.4963	127	260.6	1.762	4.1030
24	75.2	57.37	0.6159	76	168.8	7.82	2.5378	128	262.4	1.717	4.1219
25	77	54.89	0.6402	77	170.6	7.566	2.5790	129	264.2	1.674	4.1401
26	78.8	52.53	0.6651	78	172.4	7.321	2.6201	130	266	1.632	4.1581
27	80.6	50.28	0.6908	79	174.2	7.086	2.6608				
28	82.4	48.14	0.7171	80	176	6.859	2.7013				
29	84.2	46.11	0.7440	81	177.8	6.641	2.7413				
30	86	44.17	0.7716	82	179.6	6.43	2.7812				
31	87.8	42.33	0.7998	83	181.4	6.228	2.8205				

Notes:

- The Resistance of 25°C (77°F) is 10 KΩ±1%. The relation between voltage and resistance is: $V = \frac{8.06}{8.06+R} * 5$

4.2 Pressure Sensor Voltage Characteristics
Table 6-4.3: Low pressure sensor resistance characteristics

Low pressure (MPa)	Low pressure (psi)	Resistance (KΩ)	Output voltage(V)	Low pressure (MPa)	Low pressure (psi)	Resistance (KΩ)	Output voltage(V)
0.1	14.5	49.51142857	0.7	0.68	98.6	13.60666667	1.86
0.11	16	47.91222222	0.72	0.7	102	13.15052632	1.9
0.12	17.4	46.39945946	0.74	0.73	106	12.50122449	1.96
0.13	18.9	44.96631579	0.76	0.76	110	11.89049505	2.02
0.14	20.3	43.60666667	0.78	0.78	113	11.5031068	2.06
0.15	21.8	42.315	0.8	0.81	117	10.94943396	2.12
0.16	23.2	41.08634146	0.82	0.84	122	10.42623853	2.18
0.17	24.7	39.91619048	0.84	0.87	126	9.931071429	2.24
0.18	26.1	38.80046512	0.86	0.9	131	9.46173913	2.3
0.19	27.6	37.73545455	0.88	0.93	135	9.016271186	2.36
0.21	30.5	35.74434783	0.92	0.96	139	8.592892562	2.42
0.22	31.9	34.81234043	0.94	0.99	144	8.19	2.48
0.23	33.4	33.91916667	0.96	1.02	148	7.806141732	2.54
0.24	34.8	33.06244898	0.98	1.06	154	7.321679389	2.62
0.26	37.7	31.44980392	1.02	1.09	158	6.977313433	2.68
0.27	39.2	30.69	1.04	1.13	164	6.541449275	2.76
0.29	42.1	29.25481481	1.08	1.16	168	6.230780142	2.82
0.3	43.5	28.57636364	1.1	1.2	174	5.836551724	2.9
0.32	46.4	27.29087719	1.14	1.24	180	5.463489933	2.98
0.33	47.9	26.68137931	1.16	1.27	184	5.196578947	3.04
0.35	50.8	25.52333333	1.2	1.31	190	4.856666667	3.12
0.37	53.7	24.44	1.24	1.35	196	4.53375	3.2
0.38	55.1	23.92412698	1.26	1.39	202	4.226585366	3.28
0.4	58	22.94	1.3	1.43	207	3.934047619	3.36
0.42	60.9	22.01462687	1.34	1.48	215	3.587398844	3.46
0.44	63.8	21.14289855	1.38	1.52	220	3.324180791	3.54
0.46	66.7	20.32028169	1.42	1.56	226	3.072596685	3.62
0.48	69.6	19.54273973	1.46	1.61	233	2.773333333	3.72
0.5	72.5	18.80666667	1.5	1.65	239	2.545263158	3.8
0.52	75.4	18.10883117	1.54	1.7	247	2.273333333	3.9
0.54	78.3	17.44632911	1.58	1.75	254	2.015	4
0.56	81.2	16.81654321	1.62	1.8	261	1.769268293	4.1
0.58	84.1	16.21710843	1.66	1.85	268	1.535238095	4.2
0.61	88.5	15.37023256	1.72	1.9	276	1.312093023	4.3
0.63	91.4	14.83772727	1.76	1.95	283	1.099090909	4.4
0.65	94.3	14.32888889	1.8	2	290	0.895555556	4.5

4.3 Parameters of Excess and Insufficient Refrigerant System

Under the following conditions, the operating parameters given in Tables 6-4.4 and 6-4.5 should be observed:

- The master outdoor unit can detect all the indoor units.
- The number of indoor units displayed on DSP2 is steady and is equal to the actual number of indoor units installed.
- All stop valves are open and all indoor unit EEVs are connected to their unit's PCB.
- If the combination ratio is 100% or less, all the indoor units are currently running and if the combination ratio is more than 100%, indoor units with total capacity equal to the total capacity of the outdoor units are currently running.
- If the outdoor ambient temperature is high, the system is being run in cooling mode with the following settings: temperature 17°C; fan speed high.
- If the outdoor ambient temperature is low, the system is being run in heating mode with the following settings: temperature 30°C; fan speed high.
- The system has been running normally for more than 30 minutes.
- These parameters are more reliable in cooling only mode.

Table 6-4.4: Outdoor unit operating parameters in excess refrigerant system

Outdoor ambient temperature (T4)	°C	≥41	31 to 41	26 to 31	10 to 26	< 10
Discharge pressure (Pc)	MPa	≥3.5	≥3.4	≥2.8	≥ 2.6	≥2.4
Suction superheat (T7-Te)	°C	≤3	≤3	≤3	≤3	≤3
Discharge superheat (DSH)	°C	≤11	≤ 15	≤ 15	≤ 15	≤ 17

Table 6-4.5: Outdoor unit operating parameters in excess refrigerant system

Outdoor ambient temperature (T4)	°C	≥41	31 to 41	26 to 31	10 to 26	< 10
Discharge pressure (Pc)	MPa	≤3.0	≤2.6	≤2.4	≤2.3	≤2.2
Suction superheat (T7-Te)	°C	≥18	≥15	≥15	≥12	≥12
Discharge superheat (DSH)	°C	≥35	≥35	≥30	≥30	≥30