



Installation, Operation, and Maintenance

Variable Refrigerant Flow System Convertible Ceiling/Floor Indoor Unit Series

Models: 4TVX0018B100NB, 4TVX0024B100NB

⚠ SAFETY WARNING

Only qualified personnel should install and service the equipment. The installation, starting up, and servicing of heating, ventilating, and air-conditioning equipment can be hazardous and requires specific knowledge and training. Improperly installed, adjusted or altered equipment by an unqualified person could result in death or serious injury. When working on the equipment, observe all precautions in the literature and on the tags, stickers, and labels that are attached to the equipment.

Introduction

Read this manual thoroughly before operating or servicing this unit.

Warnings, Cautions, and Notices

Safety advisories appear throughout this manual as required. Your personal safety and the proper operation of this machine depend upon the strict observance of these precautions.

The three types of advisories are defined as follows:

⚠ WARNING Indicates a potentially hazardous situation which, if not avoided, could result in death or serious injury.

⚠ CAUTION Indicates a potentially hazardous situation which, if not avoided, could result in minor or moderate injury. It could also be used to alert against unsafe practices.

NOTICE Indicates a situation that could result in equipment or property-damage only.

Important Environmental Concerns

Scientific research has shown that certain man-made chemicals can affect the earth's naturally occurring stratospheric ozone layer when released to the atmosphere. In particular, several of the identified chemicals that may affect the ozone layer are refrigerants that contain Chlorine, Fluorine and Carbon (CFCs) and those containing Hydrogen, Chlorine, Fluorine and Carbon (HCFCs). Not all refrigerants containing these compounds have the same potential impact to the environment. Trane advocates the responsible handling of all refrigerants-including industry replacements for CFCs such as HCFCs and HFCs.

Important Responsible Refrigerant Practices

Trane believes that responsible refrigerant practices are important to the environment, our customers, and the air conditioning industry. All technicians who handle refrigerants must be certified. The Federal Clean Air Act (Section 608) sets forth the requirements for handling, reclaiming, recovering and recycling of certain refrigerants and the equipment that is used in these service procedures. In addition, some states or municipalities may have additional requirements that must also be adhered to for responsible management of refrigerants. Know the applicable laws and follow them.

⚠ WARNING

Proper Field Wiring and Grounding Required!

Failure to follow code could result in death or serious injury. All field wiring **MUST** be performed by qualified personnel. Improperly installed and grounded field wiring poses **FIRE** and **ELECTROCUTION** hazards. To avoid these hazards, you **MUST** follow requirements for field wiring installation and grounding as described in **NEC** and your local/state electrical codes.

⚠ WARNING

Personal Protective Equipment (PPE) Required!

Failure to wear proper PPE for the job being undertaken could result in death or serious injury. Technicians, in order to protect themselves from potential electrical, mechanical, and chemical hazards, **MUST** follow precautions in this manual and on the tags, stickers, and labels, as well as the instructions below:

- Before installing/servicing this unit, technicians **MUST** put on all PPE recommended for the work being undertaken. **ALWAYS** refer to appropriate **MSDS** sheets and **OSHA** guidelines for proper PPE.
- When working with or around hazardous chemicals, **ALWAYS** refer to the appropriate **MSDS** sheets and **OSHA** guidelines for information on allowable personal exposure levels, proper respiratory protection, and handling recommendations.
- If there is a risk of arc or flash, technicians **MUST** put on all PPE in accordance with **NFPA 70E** or other country-specific requirements for arc flash protection, **PRIOR** to servicing the unit.

Copyright

This document and the information in it are the property of Trane and may not be used or reproduced in whole or in part, without the written permission of Trane. Trane reserves the right to revise this publication at any time and to make changes to its content without obligation to notify any person of such revision or change.

Trademarks

All trademarks referenced in this document are the trademarks of their respective owners.

Table of Contents

Introduction	2
Warnings, Cautions, and Notices	2
Important Environmental Concerns	2
Important Responsible Refrigerant Practices	2
Model Number Description	5
Preparing for Installation	6
Accessories	6
Location Considerations	6
Unit Dimensions	7
Service Clearances	8
Installation	9
Mounting the Unit	9
Purging the Unit	10
Installing Refrigerant Piping	11
Leak Testing Pipe Connections	13
Installing the Drain System	15
Testing the Drainage	15
Insulation	16
Refrigerant Pipes	16
Drainage Hose	16
Wiring the Unit	17
Power	17
Communication	17
Electronic Expansion Valve (EEV) Kit	17
Configuration	19
Using the VRF Wireless Remote Control	19
The 2-Digit Segments	21
Configuration Modes	21
Mode 2: Option Setting	22
Mode 5: Option Setting	24
Mode A: Addressing	26
Mode d: Specific Digit Changing	27
Operation	30
Components	30
Operating Tips	30
Internal Protections	31
Operating Ranges	31

Operating Mode for Heat Pump Systems	31
Cleaning the Exterior	31
Cleaning the Air Filter	31
Periodic Maintenance Checks	32
Troubleshooting	34
Warranty For Trane Advantage™ VRF Systems and Related Accessories ...	37
Basic Warranty	37
Exclusions and Limitations	37

Model Number Description

4	T	V	D	0	0	1	8	A	1	0	0	N	A
1	2	3	4	5	6	7	8	9	10	11	12	13	14

Digit 1: Refrigerant

4 = R410A

Digit 2: Brand name

T = Trane

Digit 3: System type

V = Variable Refrigerant Flow

Digit 4: Configuration Type (also see separate tab)

B = mini 4-way cassette	L = Slim duct type (low pressure)
C = 4-way cassette	A = HSP duct type high pressure)
D = MSP duct type (mid-pressure)	X = Ceiling
E = 1-way cassette	W = High-wall

Digit 5: Reserved for future use

0 = Not currently used

Digit 6, 7, 8: Nominal capacity (Btu/h x 1,000)

006 = 6,000 Btu/h	020 = 20,000 Btu/h	060 = 60,000 Btu/h
007 = 7,000 Btu/h	024 = 24,000 Btu/h	068 = 68,000 Btu/h
009 = 9,000 Btu/h	030 = 30,000 Btu/h	076 = 76,000 Btu/h
012 = 12,000 Btu/h	036 = 36,000 Btu/h	096 = 96,000 Btu/h
018 = 18,000 Btu/h	048 = 48,000 Btu/h	

Digit 9: Major development sequence

B = Second development sequence

Digit 10: Electric power supply characteristics

1 = 220/60/1
 B = 220-240/50/1

Digit 11: Reserved for future use

0 = Not currently used

Digit 12: Controller

0 = None
 R = Remote control standard
 W = Wired control standard

Digit 13: Region of sale

N = North America (UL or ETL)



Digit 14: Minor design sequence

A = First design sequence
 B = Second design sequence

Preparing for Installation

Accessories

In addition to product literature, the following accessories are supplied with this unit. The type and quantity may differ, depending on the model.

Template	Plate hanger	Cable tie
		

Location Considerations

When deciding on a location for the indoor unit, the following factors must be considered:

- The air inlet and outlet must be unobstructed.
- The wall or ceiling must support the weight of the unit.
- The wall or ceiling must not be subject to vibration.
- Pre-plan for easy and short routing of the refrigerant tubing and wiring to the outdoor unit.
- The air must circulate freely in the area to be cooled/heated.
- Sufficient clearance must be maintained around the unit.
- Condensate must be managed correctly and safely away from the unit.
- The unit should be installed in a way that prevents unauthorized access.
- The unit must not be installed in an area that is damp or could come into contact with water (such as a laundry room).
- The unit must not be exposed to direct sunshine or to other direct heat sources.
- The filter must be able to be removed and cleaned easily.
- The unit should be placed as far as possible from fluorescent lights so the remote control is not subject to interference.
- Care should be taken to prevent harmonics generated by loose or unsupported material in close proximity to a running unit.
- The unit must not be installed in an area that is exposed to salt, machine oil, sulfide gas, or corrosive environmental conditions.

Unit Dimensions

Unit: inch (mm)

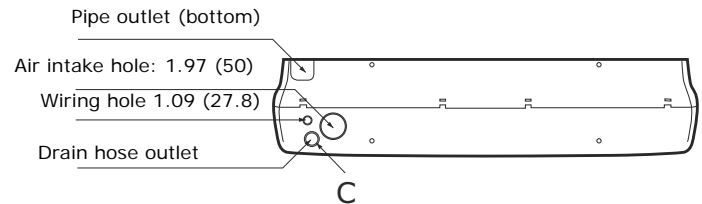
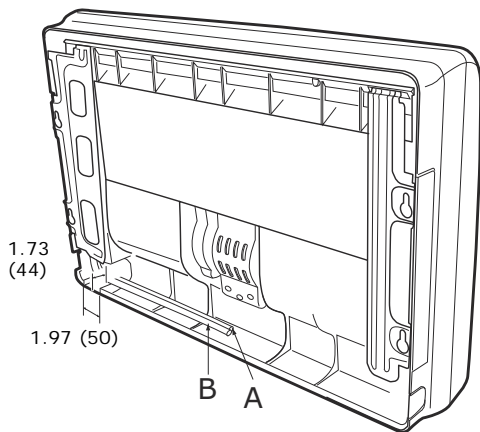
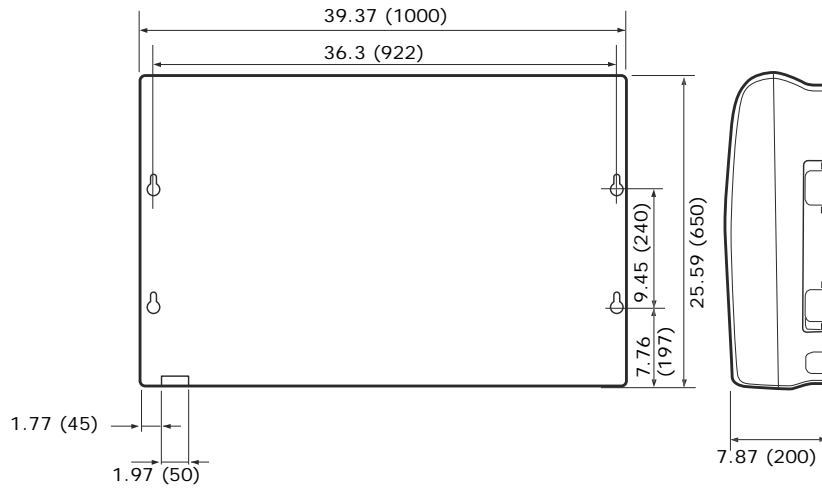

No.	Name	Description
A	Liquid pipe connection	1/4 (6.35)
B	Gas pipe connection	4TVX0018B100NB: 1/2 (12.70) 4TVX0024B100NB: 5/8 (15.88)
C	Drain pipe connection	Hose ID: 0.709 (18)

Service Clearances

Ceiling installation

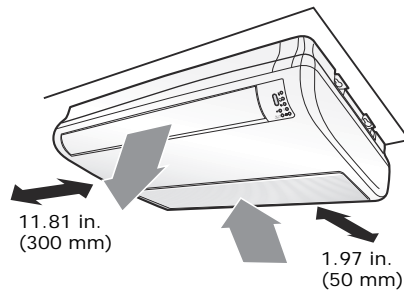

Floor installation

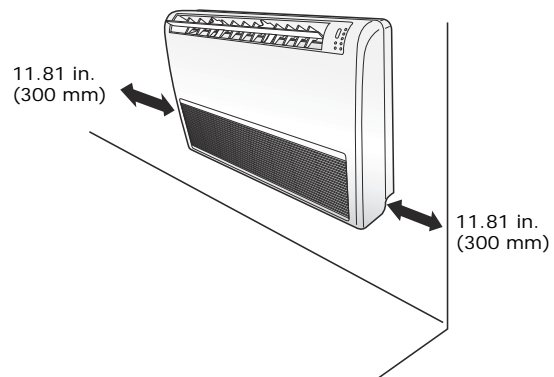

Installation

Review “Installation Considerations” before proceeding with installation.

Follow the procedures in these sections in the order given.

Notes:

- Install the Y-joint before installing the indoor unit.
- Install an electronic expansion valve (EEV) on this unit. Refer to the EEV Kit installation guide (VRF-SVN43) for information.

Mounting the Unit

Ceiling Installation

Note: If the ceiling is already constructed, piping must be laid into position before placing the unit inside the ceiling.

⚠ CAUTION

Avoid equipment damage and personal injury!

Ensure that the ceiling is strong enough to support the weight of the indoor unit. Before hanging the unit, test the strength of each of the attached suspension bolts.

1. Select the direction for the pipe connection. See figure.

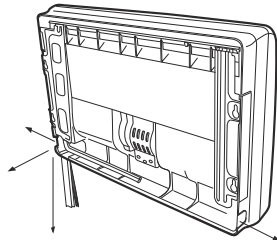

2. Use the template to locate the position for the holes for the refrigerant pipes, drain hose, and wiring.
 - Drill 3-1/8 in. (100 mm) holes for refrigerant pipes and wiring.
 - Drill 1-3/4 in. (40 mm) hole for drain hose. Holes should slant slight downward to ensure smooth water flow.
3. Install anchor bolts.
4. Install unit onto the ceiling.
 - Tilt the unit 2° lower on the side that will have the drain hose attached to it.

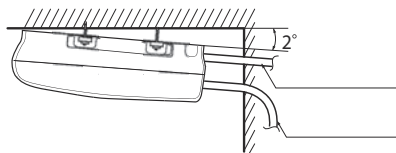

- If installing on a dropped ceiling, install a threaded rod with an anchor bolt or an expansion bolt to suspend the unit below the ceiling.

Floor Installation

1. Select the direction for the pipe connection.
2. Use the template to locate the position for the holes for the refrigerant pipes, drain hose, and cables.
 - Drill 3-1/8 in. (100 mm) holes for refrigerant pipes and cables.
 - Drill 1-3/4 in. (40 mm) hole for drain hose. Holes should slant slight downward to ensure smooth water flow.
3. Install the wall hanging plate.

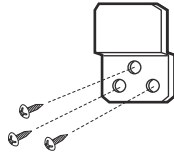

4. Install the unit on the hanging plate, tilting it slightly to the side that will have the drain hose attached to it.

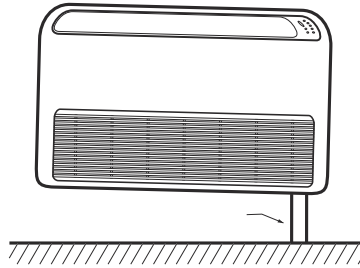

- 5.

Purging the Unit

The unit is shipped from the factory with a holding charge of nitrogen. All of this gas must be purged from the unit.

To purge the unit, remove the caps from the ends of both gas and liquid refrigerant pipes. Make sure all gas has escaped before connecting the piping.

Note: To prevent dirt or foreign objects from getting into the pipes during installation, do not remove the caps completely until you are ready to connect the piping.

Installing Refrigerant Piping

Connect field-supplied piping using flared connections (not supplied) or by brazing. The large unit port is for gas refrigerant; the small one is for liquid refrigerant.

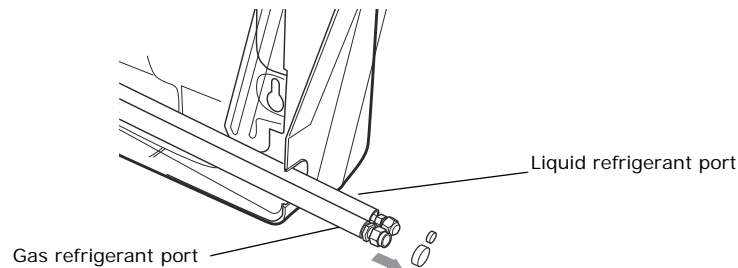

Cut or extend field-supplied piping as needed. Use the following procedures.

NOTICE

System Failure!

If brazing is used for pipe connections, a nitrogen purge is required to prevent the formation of copper oxides inside the piping. Failure to follow this procedure could damage the system.

- Before connecting the pipes, make sure they are free of dirt and debris.
- Use insulated, unwelded, degreased, and deoxidized copper pipe (Cu-DHP type according to ISO 1337 or UNI EN 12735-1) suitable for an operating pressure of at least 609.15 psi (4200 kPa) and a burst pressure of at least 3002.28 psi (20,700 kPa). Copper pipe for hydro-sanitary applications is unsuitable.
- For sizing and limits (height difference, line length, maximum bends, refrigerant charge, and so on) see the outdoor unit installation manual.
- All refrigerant connections must be accessible for servicing and maintenance.

Pipe Cutting

Required tools:

- Pipe cutter
- Reamer
- Pipe holder

1. Using a pipe cutter, cut the pipe so that the cut edge is at 90° to the side of the pipe.
2. Use a reamer to remove all burrs at the cut edge.

See examples of correctly and incorrectly cut pipes.

Correct: 90°

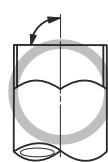

Oblique

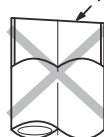

Rough



Burr



Flared Pipe Connections

Clutch type and wing nut type flare tools are available for flared pipe connections.

1. Slide the flare nut over the pipe to be flared.

Installation

- Slide the end of the pipe into the hole on the flaring bar that fits the pipe, leaving a length of pipe, determined by tool type (see table), extending above the flaring bar. Clamp it down.

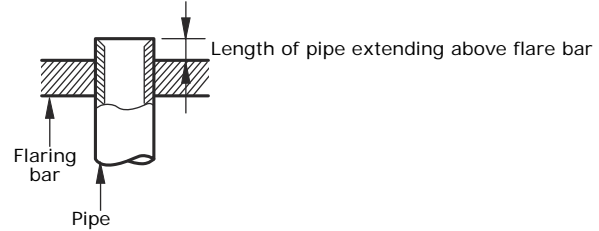

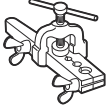
R-410A clutch type	Conventional flare tool	
	Clutch type	Wing nut type
0–0.020 in.	0.04–0.06 in.	0.06–0.08 in.
		

- Attach the yoke to the flaring bar, centering the conical part over the end of the pipe that is extending above the flaring bar.
- Tighten the yoke securely to flare the end of the pipe.

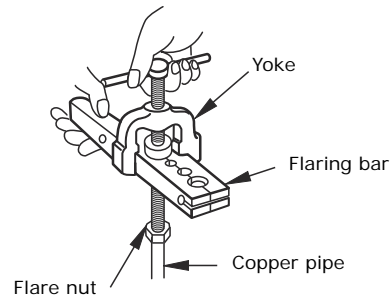

- Remove the pipe. The end of the pipe that you flared should look like the end of a trumpet. See examples of correctly and incorrectly flared pipes.



- Align the pipes and tighten the flare nuts manually and then with a spanner torque wrench, applying the torque according to pipe dimensions:

Outer diameter (in. [mm])	Connection torque (ft·lb)	Flare dimension (in.)	Flare shape (in.)
1/4 (6.35)	10.3–13.3 ft·lb	0.34–0.36	
3/8 (9.52)	25.1–31.0 ft·lb	0.50–0.52	
1/2 (12.70)	36.1–45.0 ft·lb	0.64–0.65	
5/8 (15.88)	50.2–60.5 ft·lb	0.76–0.78	

Leak Testing Pipe Connections

⚠ WARNING

Confined Space Hazards!

Do not work in confined spaces where refrigerant or other hazardous, toxic or flammable gas may be leaking. Refrigerant or other gases could displace available oxygen to breathe, causing possible asphyxiation or other serious health risks. Some gases may be flammable and or explosive. If a leak in such spaces is detected, evacuate the area immediately and contact the proper rescue or response authority. Failure to take appropriate precautions or to react properly to such potential hazards could result in death or serious injury.

⚠ WARNING

Explosion Hazard!

Never use an open flame to detect gas leaks. It could result in an explosion. Use a leak test solution for leak testing. Failure to follow recommended safe leak test procedures could result in death or serious injury or equipment or property-only-damage.

Use only dry nitrogen with a pressure regulator for pressurizing unit. Do not use acetylene, oxygen or compressed air or mixtures containing them for pressure testing. Do not use mixtures of a hydrogen containing refrigerant and air above atmospheric pressure for pressure testing as they may become flammable and could result in an explosion. Refrigerant, when used as a trace gas should only be mixed with dry nitrogen for pressurizing units. Failure to follow these recommendations could result in death or serious injury or equipment or property-only damage.

Do not exceed unit nameplate design pressures when leak testing system. Failure to follow these instructions could result in an explosion causing death or serious injury.

Notes:

- All required piping pressure tests must be completed in accordance with national and/or local codes.
 - When leak-testing refrigerant systems, observe all safety precautions.
 - Leak test only one circuit at a time to minimize system exposure to potentially harmful moisture in the air.
 - Use R-410A refrigerant gas as a tracer for leak detection and use oil-pumped dry nitrogen to develop required test pressures.
- Close liquid line angle valve.
 - Connect R-410A refrigerant cylinder to high side charging port (at condenser or field supplied discharge line access port). Add refrigerant to reach pressure of 12 to 15 psig.

Installation

3. Disconnect refrigerant cylinder. Connect dry nitrogen cylinder to high side charging port and increase pressure to 150 psig. Do not exceed high side (discharge) unit nameplate design pressure. Do not subject low side (suction) components to high side pressure.
4. Check all piping joints, valves, etc. for leaks. Recommend using electronic detector capable of measuring 0.1 oz/year leak rate.
5. If a leak is located, use proper procedures to remove the refrigerant/nitrogen mixture, break connections and make repairs. Retest for leaks.
6. Make sure all service valves are open.

Installing the Drain System

Follow these precautions and recommendations when installing the drain hose to the indoor unit:

- The hose must have a downward slope.
- The end of the hose must not be in standing water or in a hollow spot that can collect water.
- Maintain a clearance of at least 2 in. (5 cm) between the end of the hose and the ground.

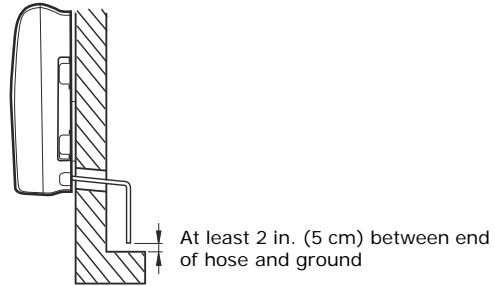

- An extension can be added to the drain hose if necessary. See figure below.

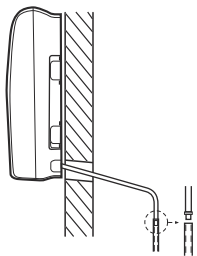

Testing the Drainage

After completing the installation, test the drainage to make sure there are no leaks:

1. Operate the unit in cool mode.
2. Remove drain pump cover.
3. Squirt water into the drain pan (see figure).
4. Confirm that the water flows out through the drain hose and that no leakage occurs at any of the connections.
5. Reassemble the drain pump cover.

Insulation

After determining that there are no leaks in the refrigerant pipes or drainage hose, insulate them as described in these sections.

Refrigerant Pipes

1. Use the table below to select the insulation type for each pipe size.

Pipe	Pipe size (in. [mm])	Insulation Type	
		Standard conditions (86°F [30°C], 85%)	High humidity conditions ^(a) (86°F [30°C], over 85%)
		EPDM or NBR	
Liquid pipe	1/4 (6.35) – 3/8 (9.52)	3/8 (9)	3/8 (9)
	1/2 (12.70) – 2 (50.80)	1/2 (13)	1/2 (13)
Gas pipe ^(b)	1/4 (6.35)	1/2 (13)	3/4 (19)
	3/8 (9.52) – 1 (25.40)	3/4 (19)	1.0 (25)
	1-1/8 (28.58) – 1-3/4 (44.45)		1-1/4 (32)
	2 (50.80)	1.0 (25)	1-1/2 (38)

(a) When installing insulation in any of the following environments, use insulation required for high humidity conditions: Buildings with close proximity to bodies of water or hot springs or on the side of a hill in which the building is partly covered by earth; ceilings frequently exposed to moisture such as in restaurants, saunas, swimming pools, and corridors of dormitories or studios near a frequently-used outdoor exit; buildings with no ventilation system.
 (b) Internal temperature of gas pipe is higher than 248°F (120°C).

2. Wrap insulation around the entire surface of each pipe, from the indoor unit to the outdoor unit, overlapping insulation to avoid gaps. Clamp insulation tightly to pipe.

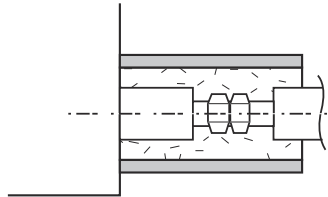

- Do not wrap the gas and liquid refrigerant pipes together.

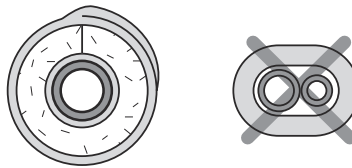

- Avoid compressing the insulation as much as possible.
- Be sure there are no cracks or deformities in the insulation at bends in pipes.
- If necessary double the insulation to prevent condensation from forming in warm or humid areas.
- Cut off excess insulation.

Drainage Hose

Insulate (field supplied) the entire surface of the drain pipe that is inside the building, including the connection between the drain hose and drain stub. Clamp tightly.

Wiring the Unit

Observe the following precautions when making electrical connections.

⚠ WARNING

Hazardous Voltage!

Disconnect all electric power, including remote disconnects before servicing. Follow proper lockout/tagout procedures to ensure the power can not be inadvertently energized. Failure to disconnect power before servicing could result in death or serious injury.

NOTICE

Use Copper Conductors Only!

Unit terminals are not designed to accept other types of conductors. Failure to use copper conductors could result in equipment damage.

- Make all electrical connections in accordance with electrical codes and ordinances.
- Select the power cable in accordance with relevant local and national regulations.
- Wire size must comply with local and national code.
- Use grade H07RN-F or H05RN-F power cable.
- Connect the power cable into the power cable terminal and fasten it with a clamp.
- Unbalanced power must be maintained within 10% of supply rating among whole indoor units.
- Significantly unbalanced power may shorten the life of the system. If the unbalanced power is greater than 10% of supply rating, the unit will stop and an error code will be generated.
- Connect the power cable to the auxiliary circuit breaker. An all-pole disconnection from the power supply must be incorporated in the fixed wiring (1/8 in. [3 mm]).
- All wiring must be protected from weather and damage.
- Maintain a distance of 2 in. (50 mm) or more between power and communication cables to prevent interference.
- Maintain a voltage drop of less than 10% between the power source and the unit(s).
- Use an appropriate screwdriver for tightening the terminal screws. A screwdriver with a small head will strip the head and make proper tightening impossible.
- Over-tightening the terminal screws may break them.
Tightening torque for M4 screws: 0.86–1.06 lbf·ft (12.0–14.7 kgf·cm).
- After making a knockout hole, apply rust-preventive paint to the bare metal around the hole.
- Secure the cable conduit to the outdoor knockout using the proper connector and bushing.

Power

Connect the power cable to terminals 1(L) and 2(N) on each indoor unit. Refer to wiring diagram.

Communication

If installing a wired remote control, connect the communication cable to terminals F3 and F4. Refer to Figure 1.

Electronic Expansion Valve (EEV) Kit

EEV kits are required for high-wall and convertible units. Refer to the Figure 1.

Wiring the Unit

Figure 1. Wiring diagram

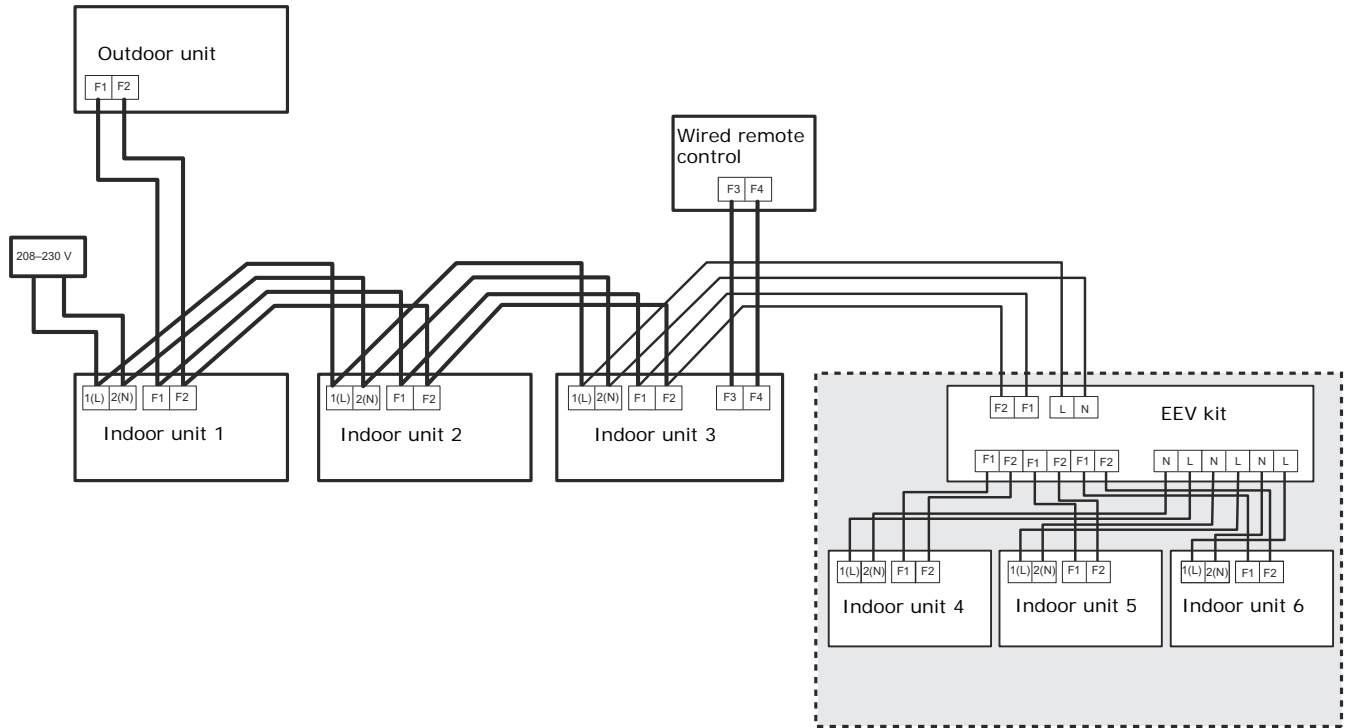

Configuration

All VRF indoor units are factory configured. If modifications are required, one of the following control devices can be used:

- VRF Wireless Remote Control (instructions follow)
- VRF Wired Remote Control
- VRF Enterprise Management Software
- VRF Auto-Commissioning Tool
- VRF System Controller

Note: Indoor unit options are configured at the factory; changes are not required for typical installations.

Using the VRF Wireless Remote Control

To change configurations of the VRF system using the VRF Wireless Remote Control, follow this procedure:

1. Remove the batteries from the remote control, and re-insert them while pressing the Temp+ and Temp- buttons simultaneously (refer to Figure 3).

The first 2-digit segment of a 24-digit sequence will appear on the wireless remote control display, as shown:

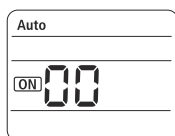

2. To advance to the next 2-digit segment, press the Mode button (Figure 3). Continue pressing the Mode button until the two-digit segment appears that corresponds to the option setting or address setting you want to view or change.

Each 2-digit segment is differentiated from the others by a combination of operation mode (Auto/Cool/Dry...) and ON/OFF icons, as shown below. (See "The 2-Digit Segments," for more detailed information.)

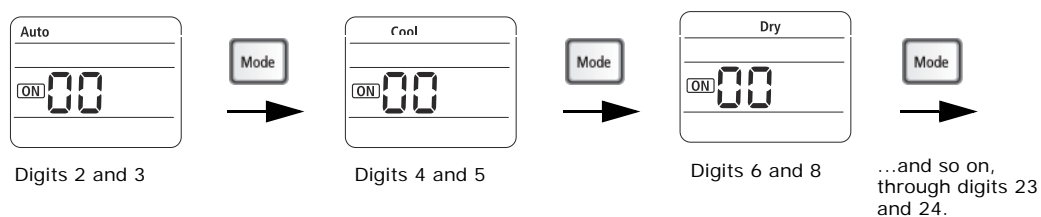

Note: Digits 1, 7, 13, and 19 do not appear and are not used for configuration.

3. To change the value of the left digit on the display, press the Fan down button. To change the value of the right digit on the display, press the Fan up button.

Note: Values and their corresponding settings are listed in the following pages of this section of the manual.

4. To save the setting, press the Power button twice.
5. To restore the wireless remote control to normal operating mode, remove the batteries from the remote control. Then re-insert them.

Figure 2. VRF Wireless Remote Control

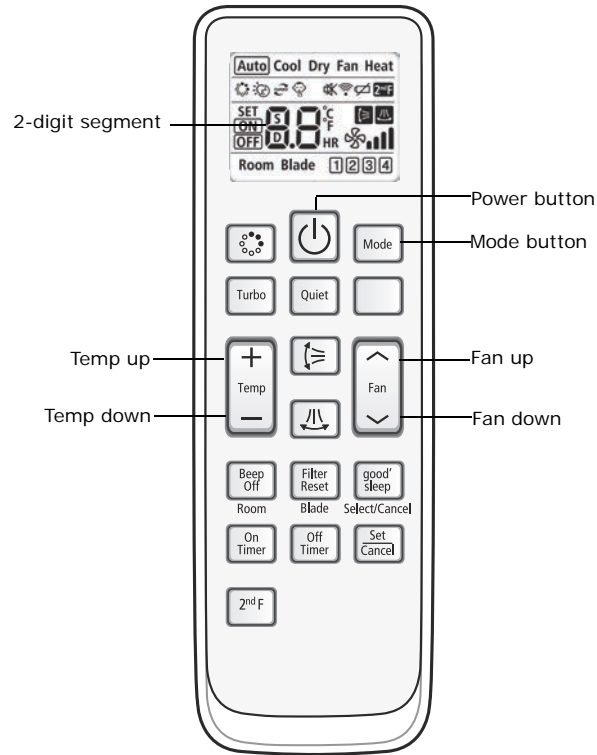

The 2-Digit Segments

Each 2-digit segment is differentiated from the others by a combination of operation mode and timer on/off icons. See Figure 4.

Figure 3. Two-digit segments in the 24-digit sequence

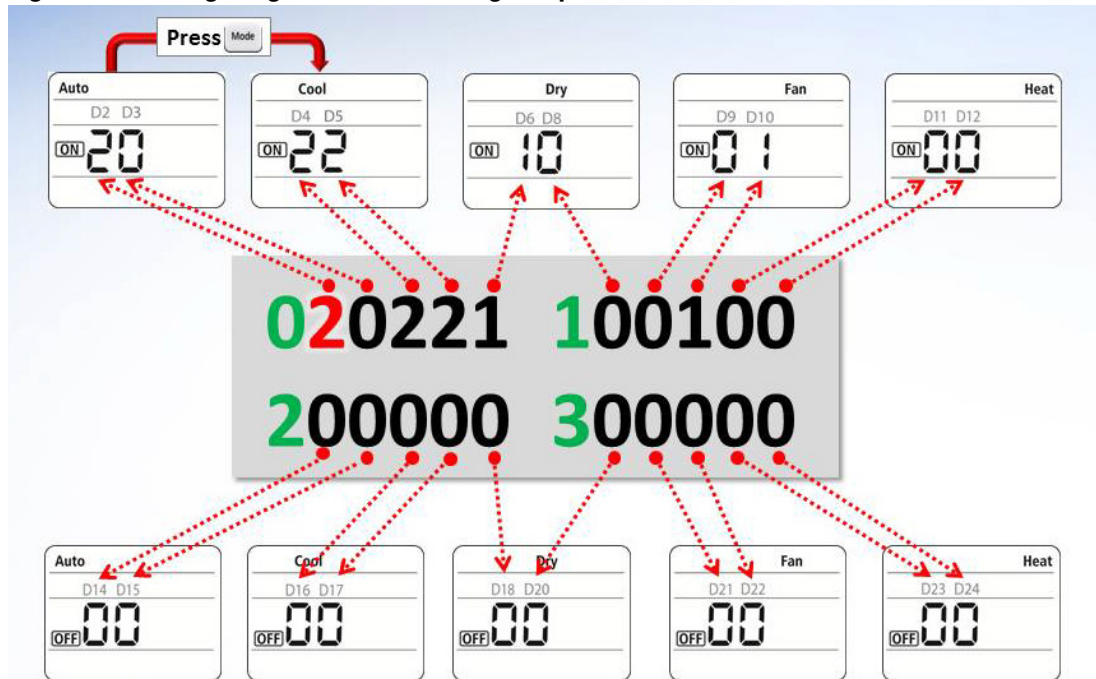

Notes:

- Digits 1, 7, 13, and 19 (shown in green) are factory set and cannot be changed. They do not appear on the display.
- Digit 2 (shown in red) is used to change the configuration mode (see “Configuration Modes” for details).
- The digit numbers shown in gray above each digit (D2, D3, etc.) do not appear on the display.

Configuration Modes

Digit 2 (shown in red in Figure 4) is used to set the configuration mode. The four modes are shown in Figure 5.

Figure 4. The four configuration modes

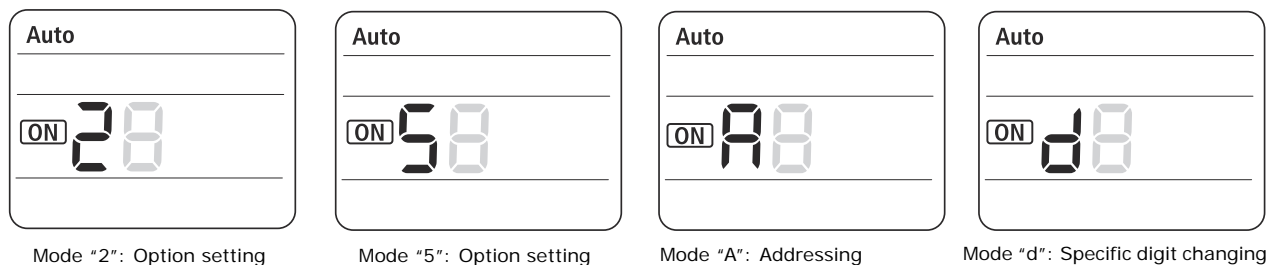

Mode "2": Option setting

Mode "5": Option setting

Mode "A": Addressing

Mode "d": Specific digit changing

Configuration

Mode 2: Option Setting

When **digit 2** is set to a value of "2," the options shown in Table 1 can be set to the values in the right column.

Table 1. Option setting mode: Digit 2 = 2



Display screen (mode and On/Off)	Digit	Option description	Set digit to...
N/A	1	Factory set to 0	Cannot be changed. Not seen in configuration mode.
	2	Option setting mode	2
	3	Robot cleaning	0: Disabled 1: Enabled
	4	Remote sensor	0: Disabled 1: Enabled
	5	Central control	0: Disabled 1: Enabled
	6	RPM up	0: Disabled 1: Enabled
N/A	7	Factory set to 1	Cannot be changed. Not seen in configuration mode.
	8	Drain pump	0: Disabled 1: Enabled (no delay) 2: Enabled (3-min delay) ^(a)
	9	Hot water heater	0: Disabled 1: Enabled
	10	Electronic heater	0: Disabled 1: Enabled
	11	EEV position when heating is satisfied	0: EEV step is minimum (default) 1: Reduced noise setting
	12	Master/Slave unit designation ^(b)	0: Slave 1: Master
N/A	13	Factory set to 2	Cannot be changed. Not seen in configuration mode.

Table 1. Option setting mode: Digit 2 = 2

Display screen (mode and On/Off)	Digit	Option description	Set digit to...
	14	External control	0: Disabled 1: On/Off control 2: Off-only control
	15	External control output	0: Thermostat control 1: User controlled input
	16	S-plasma ion	0: Disabled 1: Enabled
	17	Buzzer	0: Enabled 1: Disabled
	18	Filter timer (hours of use)	2: 1000 6: 2000
N/A	19	Factory set to 3	Cannot be changed. Not seen in configuration mode.
	20	Associating wireless remote control with indoor unit(s)	0, 1: Channel 1 2: Channel 2 3: Channel 3 4: Channel 4
	21	Heat setting compensation	0: Disabled 1: 3.6°F (2°C) 2: 9°F (5°C)
	22	EEV step of stopped unit during oil return/defrost mode	0: EEV step is minimum 1: Oil return or reduce noise in defrost mode
	23	Motion detection sensor	0: Disabled 1: Disabled in 30 minutes if no motion is detected 2: Disabled in 60 minutes if no motion is detected 3: Disabled in 120 minutes if no motion is detected 4: Disabled in 180 minutes if no motion is detected 5: Disabled in 30 minutes if no motion is detected and advanced function ^(c) 6: Disabled in 60 minutes if no motion is detected and advanced function 7: Disabled in 120 minutes if no motion is detected and advanced function 8: Disabled in 180 minutes if no motion is detected and advanced function
	24	N/A	—

(a) Cassette-type indoor units are set to "Enabled (3-minute delay)" regardless of digit 8 setting.
 (b) For heat pump systems, the master indoor unit controls whether the system operates in heating or cooling. If the master indoor unit calls for heating and slave indoor units call for cooling, the master indoor unit (and any other slave indoor units that call for heating) will operate in heating mode. The slave indoor units that call for cooling will do nothing.
 (c) Advanced function: Controls heating/cooling or power saving with motion detection.

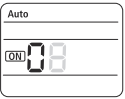
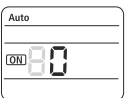
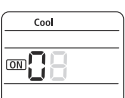
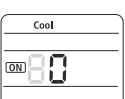
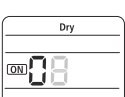
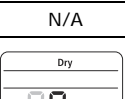
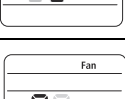
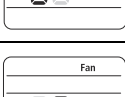
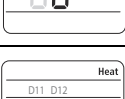
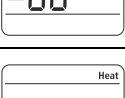
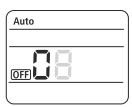
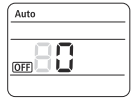
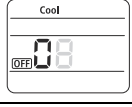
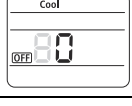
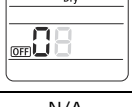
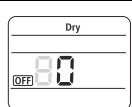
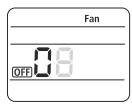
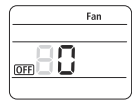
Configuration

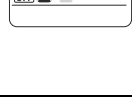
Mode 5: Option Setting

When **digit 2** is set to a value of "5," the options shown in Table 2 can be changed to the values in the right column.

Table 2. Option setting mode: Digit 2 = 5

Display screen (mode and On/Off)	Digit	Option description	Set digit to...
	1	Factory set to 0	Cannot be changed. Not seen in configuration mode.
	2	Option setting mode	5
	3	Auto-changeover (HR only)	0: Disabled 1: Enabled (see Figure 6)
	4	Heating deadband Note: Applies only when digit 3 is set to "1" (auto-changeover mode is enabled).	0: Disabled 1: 0.9°F (0.5°C) 2: 1.8°F (1°C) 3: 2.7°F (1.5°C) 4: 3.6°F (2°C) 5: 4.5°F (2.5°C) 6: 5.4°F (3°C) 7: 6.3°F (3.5°C)
	5	Cooling deadband Note: Applies only when digit 3 is set to "1" (auto-changeover mode is enabled).	0: Disabled 1: 0.9°F (0.5°C) 2: 1.8°F (1°C) 3: 2.7°F (1.5°C) 4: 3.6°F (2°C) 5: 4.5°F (2.5°C) 6: 5.4°F (3°C) 7: 6.3°F (3.5°C)
	6	Standard for auto-changeover (heating to cooling) Note: Applies only when digit 3 is set to "1" (auto-changeover mode is enabled).	0: 1.8°F (1°C) 1: 2.7°F (1.5°C) 2: 3.6°F (2°C) 3: 4.5°F (2.5°C) 4: 5.4°F (3°C) 5: 6.3°F (3.5°C) 6: 7.2°F (4°C) 7: 8.1°F (4.5°C)
	7	Factory set to 1	Cannot be changed. Not seen in configuration mode.
	8	Standard for auto-changeover (cooling to heating) Note: Applies only when digit 3 is set to "1" (auto-changeover mode is enabled).	0: 1.8°F (1°C) 1: 2.7°F (1.5°C) 2: 3.6°F (2°C) 3: 4.5°F (2.5°C) 4: 5.4°F (3°C) 5: 6.3°F (3.5°C) 6: 7.2°F (4°C) 7: 8.1°F (4.5°C)

Table 2. Option setting mode: Digit 2 = 5

Display screen (mode and On/Off)	Digit	Option description	Set digit to...
	9	Time required for mode change Note: Applies only when digit 3 is set to "1" (auto-changeover mode is enabled).	0: 5 minutes 1: 7 minutes 2: 9 minutes 3: 11 minutes 4: 13 minutes 5: 15 minutes 6: 20 minutes 7: 30 minutes
	10	Compensation option for height or pipe length difference between indoor units	0: Use default value 1: Use when height or pipe length difference is as specified in Note 1. 2: Use when height or pipe length difference is as specified in Note 2.

Notes:

- Height difference between the indoor unit being configured and the lowest indoor unit is > 98.4 ft (30 m), or pipe length difference between the outdoor unit and the furthest indoor unit and the outdoor unit and the indoor unit being configured is > 360.9 ft (110 m).
- Height difference between the indoor unit being configured and the lowest indoor unit is 49.2–98.4 ft (15–30 m), or pipe length difference between the outdoor unit and the furthest indoor unit and the outdoor unit and the indoor unit being configured is 164–360.9 ft (50–110 m).

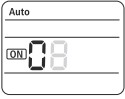
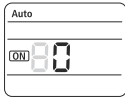
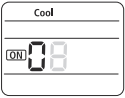
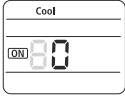
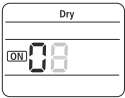
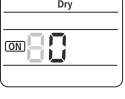
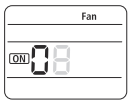
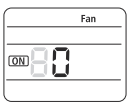
Example: If the unit being configured is 60 ft away from the outdoor unit, and the furthest indoor unit is 300 ft from the outdoor unit, the pipe length difference is 240 ft (300-60=240), so Digit 10 should be set to "2."

Figure 5. Heat recovery unit operating in auto-changeover mode

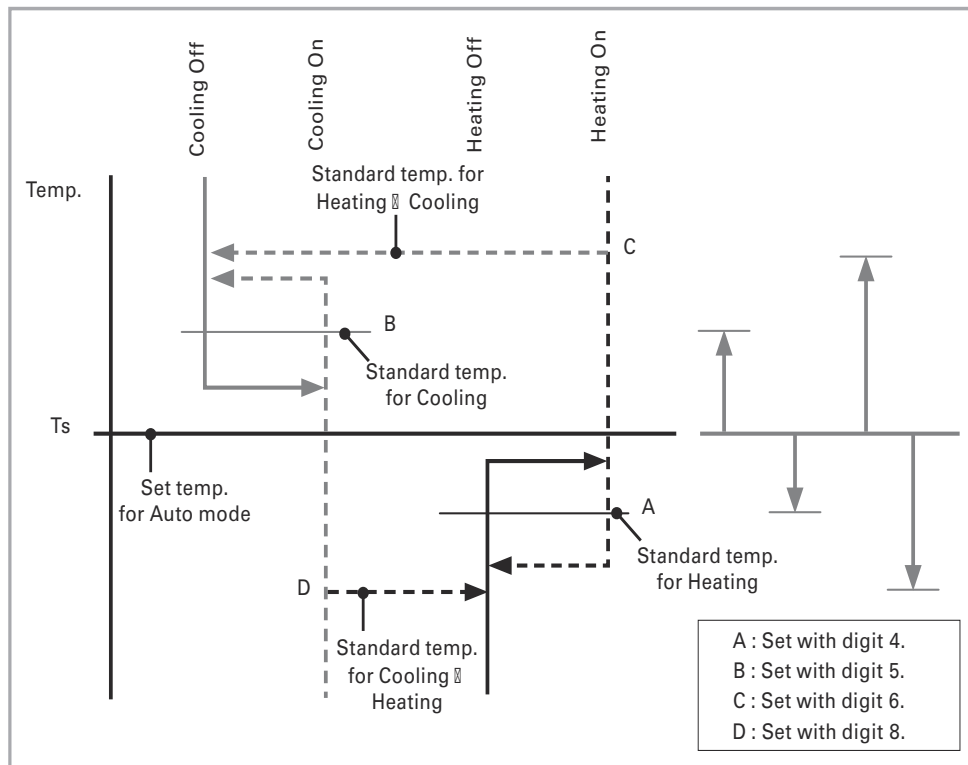

Note: Minimum compressor off time for heating or cooling is set by digit 9.

Mode A: Addressing

When **digit 2** is set to a value of “A,” unit address settings can be changed. See Figure 7, Figure 8, and Table 3.

The indoor unit is factory-configured for auto-addressing mode. The factory default address is **0A0000-100000-200000-300000**. If the default address is manually changed, the auto-addressing mode is no longer active.

If the address has been manually changed, and the installer wants to restore auto-addressing mode, all indoor units in the system must be returned to the initial factory default address.

Figure 6. Address setting mode (digit 2 = A): Digits 2–6

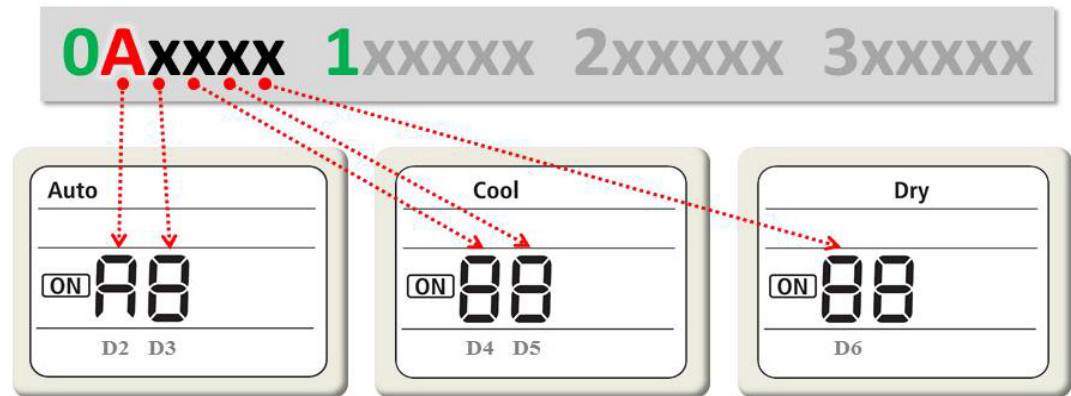

Figure 7. Addressing mode for remote control, Digits 9–12

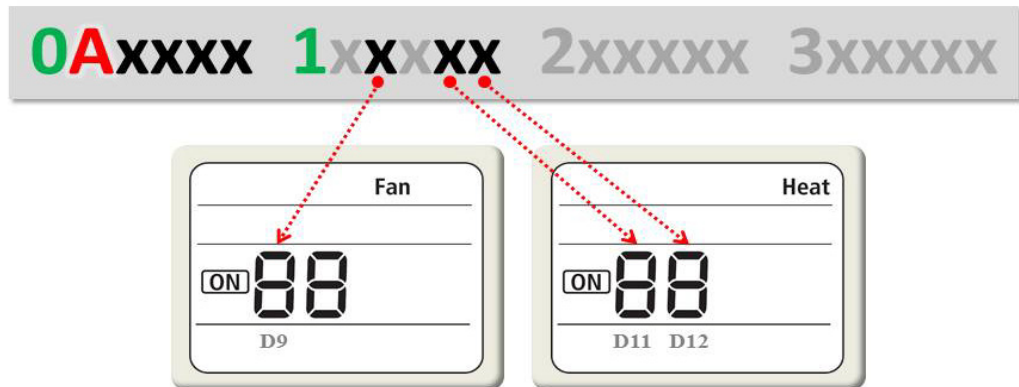
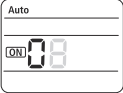
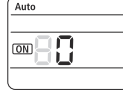
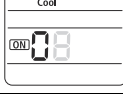
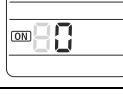
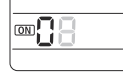

Table 3. Address setting mode: Digit 2 = A

Display screen (Mode and On/Off)	Digit	Option	Set digit to...
	1	Factory set to 0	Cannot be changed. Not seen in configuration mode.
	2	Addressing mode	A
	3	Unit/RMC address	0: Automatic address setting (default) 1: Manual address setting
	4	Hundreds digit of address	Address
	5	Tens digit of address	Address
	6	Ones digit of address	Address

Mode d: Specific Digit Changing

When **digit 2** is set to a value of “d,” a single, specific digit can be changed. See Figures 9–11 and Table 4. This mode can be used as a shortcut when only a single digit needs to be changed.

Figure 8. Specific digit changing mode

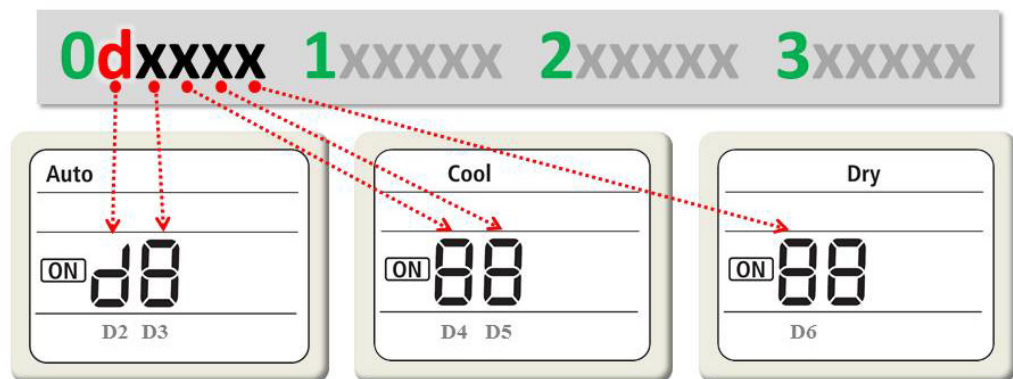

The example in Figure 10 shows how to use this mode to change the external control option setting from On/Off control to Off-only control. (For the details on this option, see Table 1.)

Figure 9. Example of using the specific digit changing mode to change an option setting

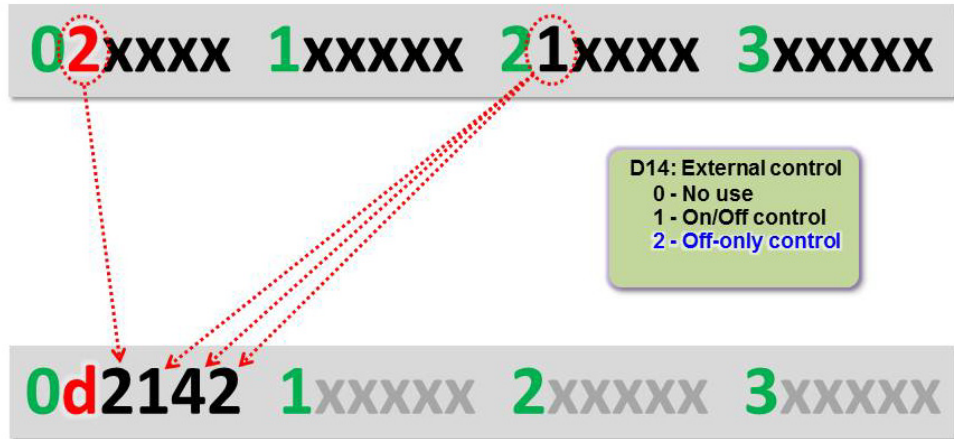

- Digit 2 is set to "d" (the specific digit setting mode).
- Digit 3 is set to "2" (the option setting mode; refer to "Mode 2: Option Setting").
- Digits 4 and 5 are set to "14" (the position of the digit for external control; refer to Table 1).
- Digit 6 is changed from "1" (On/Off control) to "2" (Off-only control); refer to Table 1.

The example in Figure 11 shows how to use this mode to change a unit address from "137" to "134."

Figure 10. Example of using the specific digit changing mode to change a unit address



- Digit 2 is set to "d" (the specific digit setting mode).
- Digit 3 is set to "A" (the addressing mode).
- Digits 4 and 5 are set to "06" because the 6th digit ("7") is the digit that is to be changed.
- Digit 6 is changed from "1" (On/Off control) to "2" (Off-only control).

Table 4. Specific digit changing mode: Digit 2 = d

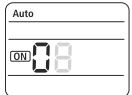
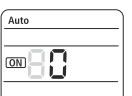
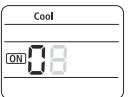
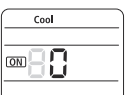
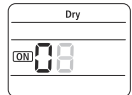
Display screen (Mode and On/Off)	Digit	Option	Set digit to...
	1	Factory set to 0	Cannot be changed. Not seen in configuration mode.
	2	Specific digit changing mode	d
	3	Configuration setting mode	The desired setting mode: 1, 2, 5, or A (see Figure 5)
	4	Position of digit in 24-digit sequence: Tens digit	Value that represents position (such as "0" if it is the 9th digit in the sequence)
	5	Position of digit in 24-digit sequence: Ones digit	Value that represents position (such as "9" if it is the 9th digit in sequence)
	6	Setting value	Appropriate value for operation, function, or address

Operation

Familiarize yourself with the unit components and operating tips before operating the unit.

Components

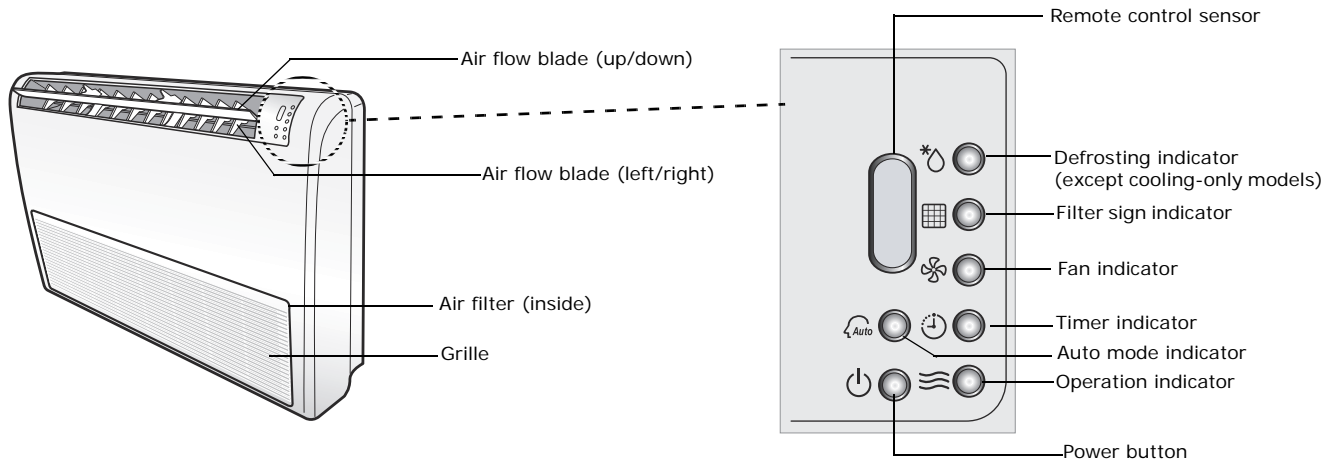

Note: Your unit and display may look slightly different from the illustration shown above, depending on your model.

Operating Tips

Follow these tips when using your unit:

Cooling	If the outside temperature is much higher than the selected indoor temperature, it may take longer than expected to achieve the desired temperature. Avoid making extreme changes in the temperature setting. This practice wastes energy and does not cool the room faster.
Heating	Because the unit heats the room by removing heat energy from outdoor air, the heating capacity may decrease when outdoor temperatures are extremely low. If the unit provides insufficient heat, use an additional heating source in combination with the unit.
Defrost	When the unit runs in Heat mode, frost may form due to the temperature difference between the unit and the outside air. If this happens: <ul style="list-style-type: none"> • The unit stops heating. • The unit will operate automatically in Defrost mode for 10 minutes. • The steam produced on the outdoor unit in Defrost mode is safe. No intervention is required; after about 10 minutes, the unit will resume normal operation. The unit will not operate when it starts to defrost.
Fan	The fan may not operate for 3–5 minutes after turning on the unit, to prevent cold air from blowing on occupants while the unit is warming up.
High indoor and outdoor temperatures	If both indoor and outdoor temperatures are high and the unit is running in Heat mode, the outdoor unit fan and compressor may stop at times. This is normal; wait until the unit turns on again.
Power failure	A power failure will cause the unit to stop operating. When power returns, the unit will automatically resume operation.
Minimum Off Timer	If the unit has just been turned on, it will not produce cool/warm air for 3 minutes. This delay mechanism protects the outdoor unit compressor.

Internal Protections

Internal protections operate if an internal fault occurs in the unit.

Type	Description
Cold air dump	The internal fan will be off to prevent a cold air dump when the heat pump is in defrost mode.
Defrost cycle	The internal fan will be off to prevent a cold air dump when the heat pump is in defrost mode.
Anti-short cycle timer	The compressor observes a 3-minute off time when cycling power to the unit or after an outage.

Note: If the heat pump is operating in Heat mode, a defrost cycle is activated to remove frost from an outdoor unit that may have accumulated at low temperatures. The internal fan is switched off automatically and restarted only after the defrost cycle is completed.

Operating Ranges

For efficient use, operate the unit within the ranges shown in this table.

Mode	Outdoor temperature	Indoor temperature	Indoor humidity
Cooling	23°F (-5°C) to 118°F (48°C)	64°F (18°C) to 90°F (32°C)	80% or less
Heating	-4°F (-20°C) to 75°F (24°C)	81°F (27°C) or less	—
Drying	23°F (-5°C) to 118°F (48°C)	64°F (18°C) to 90°F (32°C)	—

Note: The standardized temperature for heating is 45°F (7°C). If the outdoor temperature drops to 32°F (0°C) or below, the heating capacity can be reduced depending on the temperature condition. If the cooling operation is used at over 90°F (32°C) (indoor temperature), it does not cool at its full capacity.

Operating Mode for Heat Pump Systems

For heat pump systems, the main indoor unit controls whether the system operates in heating or cooling. If the main indoor unit calls for heating and sub-indoor units call for cooling, the main indoor unit (and any other sub-indoor units that call for heating) will operate in heating mode, and the sub-indoor units that call for cooling will do nothing.

Cleaning the Exterior

Use a dry or damp cloth to wipe the surface of the unit as needed. If necessary, use mild soap and water on a damp cloth. Use a soft brush to remove dirt from the grill.

NOTICE

Avoid equipment damage and risk of fire!

Avoid using benzene or other flammable solvents. They may damage the surface of the unit and increase the potential for fire.

Cleaning the Air Filter

1. Open the grill by pressing the "PUSH" signs, located in three places.

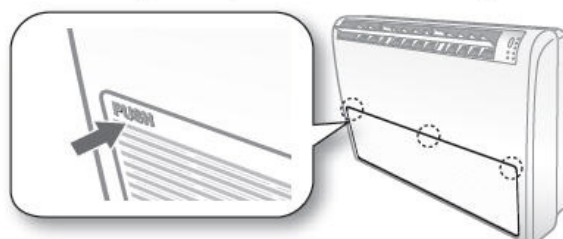

Operation

2. Hold the grill at a 45° angle. Push the bottom of the grill to make sure it is unhooked. Then lift up the grill.

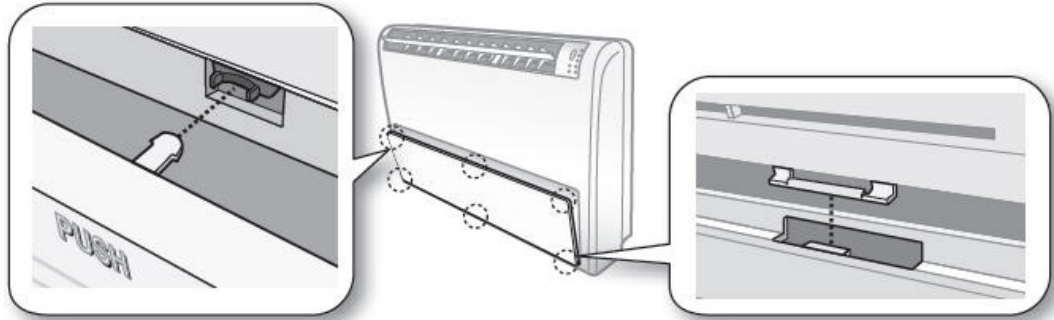

3. To remove the air filter, press it slightly and pull it out.

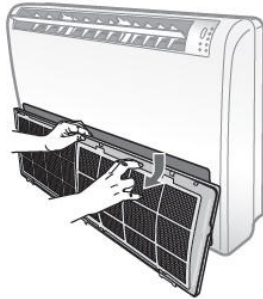

4. Clean the grill and air filter with a vacuum or soft brush. If the dust is too thick, rinse them under running water and dry in a well-ventilated area.

Note: Drying the air filter in a confined or humid area may cause odors to develop. If odors occur, re-clean and dry it in a well-ventilated area.

5. Replace the air filter in its original position.
6. After cleaning the air filter, press the Filter Reset button on the remote control for 2 seconds to reset the filter schedule. The filter indicator lights when it is time to clean the filter again.
7. Replace the grill by reversing the first three steps.

Note: If the angle on the air flow blades changed from opening the grill, turn the circuit breaker off and on again to restore the blades to their proper angle.

Periodic Maintenance Checks

Refer to the schedule given in Table 5 for proper unit maintenance.

Note: If the unit will not be used for an extended period of time, operate it in Fan mode for 3–4 hours to thoroughly dry it and then disconnect the power plug. Moisture left in the components can cause odors and internal damage.

Table 5. Maintenance schedule

Description	Monthly	Every 4 months	Once a year	As needed
Clean the air filter ^(a)	x			
Clean the condensate drain pan ^(b)			x	
Thoroughly clean the heat exchanger ^(b)			x	
Clean the condensate drain pipe ^(b)		x		
Replace remote control batteries ^(a)				x

(a) The described operations should be performed more frequently if the area of installation is very dusty.

(b) These operations must always be performed by qualified personnel. For more detailed information, see the installation manual for this unit.

Troubleshooting





Refer to Table 6 for solutions to common problems and to Table 7 for a list of alarm conditions with corresponding error codes and LED behavior.

Table 6. Solutions to common problems

Problem	Solution
The unit does not operate immediately after restarting it.	The anti-short cycle timer prevents the unit from operating immediately to keep it from overloading. The unit will start in 3 minutes.
The unit does not operate.	Verify the following: The power plug is properly inserted into the wall receptacle. There has not been a power failure. The circuit breaker is switched on/fuses are good.
The temperature does not change.	Verify that the unit is not operating in Fan mode. If it is, select a different mode.
The unit is not producing warm/cool air.	Verify the following: Temperature setting on remote control is higher/lower than the current temperature. Air filter is not clogged with dirt. If the unit has just been turned on, wait 3 minutes for the anti-short cycle timer to expire. Air flow is unobstructed. Line size and length is correct and does not exceed factory recommendations. Operating mode is heat/cool. If unit is not producing warm air, is it set to Cool mode? Remote control is not for a cooling-only unit. That the unit has not been installed in direct sunlight. If so, hang curtains or shades on windows to filter the sun and increase unit efficiency.
The fan speed does not change.	Verify that Auto or Dry mode is selected. Either of these modes automatically adjust the fan speed.
Timer function does not work.	Press the Power button on the remote control after setting the time.
Odors permeate the room during operation.	Verify the origin of the odor. Operate the unit in Fan mode or open the windows to air out the room.
The unit makes a bubbling sound	A bubbling sound may be heard: When the refrigerant is circulating through the compressor. By the drain pump inside the unit when you press the Power button.
Water is dripping from the air flow blades.	If the unit has been running for an extended period of time with the blades fully open, adjust the blades to mid-position to alleviate condensation formation.
The remote control is not working.	Verify that: Batteries are not depleted. Batteries are correctly installed. Nothing is blocking the remote control sensor. No strong fluorescent or neon lighting is near the unit, which may interrupt the signal.
The unit does not turn on/off with the wired remote control.	Ensure that the wired remote control is not set for Group Control.
Indicators on the digital display flash.	Press the Power button on the remote control to turn the unit off. Then switch the circuit break off and then on again.





If an error occurs, one of more of the LEDs on the display (see “Components” for their location) will flicker. As a protection strategy, the unit stops operating (and the LED turns off). If the unit is turned on before the problem is resolved, the LED will resume flickering and the unit will stop operating again.

Table 7. Diagnostic LEDs for the convertible indoor unit

Alarm condition	Error code	LED display				
		Power 	Timer 	Fan 	Filter 	Defrost 
Indoor temperature sensor error (shorted or open)	E121	Off	Flickering	Off	Off	Off
Evap-in sensor error (shorted or open)	E122	Flickering	Flickering	Off	Off	Off
Evap-out sensor error (shorted or open)	E123					
Discharge sensor error (shorted or open)	E126					
Indoor fan error	E154	Off	Off	Flickering	Off	Off
Outdoor temperature sensor error (shorted or open)	E221	Flickering	Off	Flickering	Off	Off
Condenser sensor error (shorted or open)	E237					
Discharge sensor error	E251					
No communication between indoor and outdoor units for 2 minutes	E101	Off	Flickering	Flickering	Off	Off
Communication error received from outdoor unit	E102					
3-minute tracking error on outdoor unit	E202					
Communication error after tracking due to non-matching quantity of installed indoor units	E201					
Error due to repeated communication address	E108					
Communication address not confirmed	E109					
Error due to opened EEV (2nd detection)	E151	Off	Flickering	Flickering	Flickering	Off
Error due to closed EEV (2nd detection)	E152					
Evap-in sensor is loose	E128					
Evap-out sensor is loose	E129					
Thermal switch error (open)	E198					

Troubleshooting

Table 7. Diagnostic LEDs for the convertible indoor unit

Alarm condition	Error code	LED display				
		Power 	Timer 	Fan 	Filter 	Defrost 
Condenser mid-sensor is loose	E241	Off	Flickering	Flickering	Flickering	Off
Refrigerant leakage (2nd detection)	E554					
Abnormally high temperature on condenser (2nd detection)	E450					
Low pressure switch (2nd detection)	E451					
Abnormally high discharge air temperature on outdoor unit (2nd detection)	E416					
Indoor unit operation stopped due to unconfirmed error on outdoor unit	E559					
Reverse phase detection error	E425					
Compressor operation stop due to freeze detection(6th detection)	E403					
High pressure sensor is loose	E301					
Low pressure sensor is loose	E306					
Outdoor unit compression ratio error	E428					
Outdoor sump down_1 prevention control	E413					
Compressor operation stopped due to low pressure sensor prevention control	E410					
Simultaneous opening of cooling/heating MCU solenoid valve (1st detection)	E180					
Simultaneous opening of cooling/heating MCU solenoid valve (2nd detection)	E181					
Float switch	E153	Off	Off	Flickering	Flickering	Off
EEPROM error	E162	Flickering	Flickering	Flickering	Flickering	Flickering
EEPROM option error	E163	Flickering	Flickering	Flickering	Flickering	Flickering
Incompatible indoor unit error	E164	Off	Off	Off	Flickering	Off

Warranty For Trane Advantage™ VRF Systems and Related Accessories

Products Covered. This warranty is extended by Trane, and applies to all Trane Advantage™ VRF systems and accessories for these products which are sold by Trane and applied in accordance with Trane specifications.

Basic Warranty

The warrantor warrants for a period of 12 months from the initial start-up or 18 months from date of shipment, whichever is less, against failure due to defects in material and manufacture and that it has the capacities and ratings set forth in Company's catalogs and bulletins ("Warranty").

If the following conditions are met, the warrantor extends this basic warranty period to five (5) years from date of start-up:

- The system is designed using an approved application tool (VRF Select).
- The system is installed by a contractor who has successfully completed a Trane factory training class.
- A verified commissioning report from the Trane VRF Commissioning Tool is submitted.

Exclusions and Limitations

Exclusions from this Warranty include damage or failure arising from: wear and tear; corrosion, erosion, deterioration; modifications made by others to the Equipment; repairs or alterations by a party other than Company that adversely affects the stability or reliability of the Equipment; vandalism; neglect; accident; adverse weather or environmental conditions; abuse or improper use; improper installation; commissioning by a party other than Company; unusual physical or electrical or mechanical stress; operation with any accessory, equipment or part not specifically approved by Company; refrigerant not supplied by Company; and/or lack of proper maintenance as recommended by Company. Company shall not be obligated to pay for the cost of lost refrigerant or lost product. Company's obligations and liabilities under this Warranty are limited to furnishing replacement equipment or parts, at its option, FCA (Incoterms 2000) factory or warehouse (f.o.b. factory or warehouse for US domestic purposes) at Company-designated shipping point, freight-allowed to Company's warranty agent's stock location, for all non-conforming Company-manufactured Equipment (which have been returned by Customer to Company. Returns must have prior written approval by Company and are subject to restocking charge where applicable. Equipment, material and/or parts that are not manufactured by Company are not warranted by Company and have such warranties as may be extended by the respective manufacturer. **COMPANY MAKES NO REPRESENTATION OR WARRANTY, EXPRESS OR IMPLIED, REGARDING PREVENTION OF MOLD/MOULD, FUNGUS, BACTERIA, MICROBIAL GROWTH, OR ANY OTHER CONTAMINATES.** No warranty liability whatsoever shall attach to Company until Customer's complete order has been paid for in full and Company's liability under this Warranty shall be limited to the purchase price of the Equipment shown to be defective. EXCEPT FOR COMPANY'S WARRANTY EXPRESSLY SET FORTH HEREIN, COMPANY DOES NOT MAKE, AND HEREBY EXPRESSLY DISCLAIMS, ANY WARRANTIES, EXPRESS OR IMPLIED CONCERNING ITS PRODUCTS, EQUIPMENT OR SERVICES, INCLUDING, WITHOUT LIMITATION, ANY WARRANTY OF DESIGN, MERCHANTABILITY OR OF FITNESS FOR A PARTICULAR PURPOSE, OR OTHERS THAT ARE ALLEGED TO ARISE FROM COURSE OF DEALING OR TRADE.

Additional warranty protection is available on an extra-cost basis and must be in writing and agreed to by an authorized signatory of the Company. Additional terms and conditions of warranty coverage are applicable for refrigeration equipment. If you wish further help or information concerning this warranty, contact: Trane—Warrantor, 2701 Wilma Rudolph Blvd., Clarksville, TN 37040.





The manufacturer optimizes the performance of homes and buildings around the world. A business of Ingersoll Rand, the leader in creating and sustaining safe, comfortable and energy efficient environments, the manufacturer offers a broad portfolio of advanced controls and HVAC systems, comprehensive building services, and parts. For more information, visit www.IRCO.com.

The manufacturer has a policy of continuous product and product data improvement and reserves the right to change design and specifications without notice.